

CAMO[®]

The Better Way to Build a Deck

2023 PRODUCT CATALOG

CLIPDRIVE™

STAND UP DECK CLIP FASTENING SYSTEM

DRIVE™

STAND UP 3-IN-1 FASTENING SYSTEM

LEVER®

BOARD BENDING + LOCKING TOOL

MARKSMAN

HIDDEN EDGE SCREW FASTENING SYSTEM



FEATURING
NEW

CODE-COMPLIANT
STRUCTURAL SCREWS

SEE PAGES 32-40

THE BETTER WAY TO BUILD A DECK.

FASTENING SYSTEMS



CLIPDRIVE™

STAND-UP DECK CLIP FASTENING SYSTEM

The Better Way to Fasten CAMO Universal Deck Clips.

PAGES 4-5

FOR USE WITH CAMO UNIVERSAL DECK CLIPS



NEVER-MISS GUIDE™

DECK CLIP FASTENING SYSTEM

Included in every pail of CAMO Universal Deck Clips.

PAGES 6-7

FOR USE WITH CAMO UNIVERSAL DECK CLIPS



DRIVE™

STAND-UP 3-IN-1 FASTENING SYSTEM

Save time with the award-winning CAMO DRIVE™ tool.

PAGES 8-9

FOR USE WITH CAMO COLLATED EDGE + FACE SCREWS OR CAMO UNIVERSAL DECK CLIPS



MARKSMAN™

HIDDEN EDGE SCREW FASTENING SYSTEM

Achieve a fastener-free surface on square decking.

PAGES 14-15

FOR USE WITH CAMO EDGE SCREWS

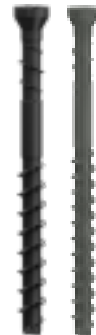

ACCESSORIES



PAGES 20-21 BOARD BENDING & LOCKING TOOL

ACCESSORIES

- POWER BITS
- DRIVE™ + CLIPDRIVE™ T-15
- DRIVE™ T-20
- DRIVER BITS
- PRE-DRILL BIT

FASTENERS FOR EVERY PROJECT

SYSTEM FASTENERS

For exclusive use with CAMO® systems



CAMO EDGE SCREWS



CAMO COLLATED EDGE + FACE SCREWS

CAMO UNIVERSAL DECK CLIPS



EXTERIOR FASTENERS

For Deck, Composite, Trim, or Structural connections.

DECK



COMPOSITE



TRIM



CODE-COMPLIANT STRUCTURAL SCREWS



TRUSS



MULTI-PLY + LEDGER FLAT HEAD SCREWS



FRAMING SCREWS



MULTI-PURPOSE FLAT HEAD SCREWS



MULTI-PURPOSE HEX HEAD SCREWS



MULTI-PURPOSE HEX HEAD SCREWS



STAINLESS STEEL



305 & 316 COMPOSITE SCREWS



316 JOIST HANGER NAILS (COLLATED AVAILABLE)



305 & 316 DECK SCREWS



316 RING SHANK DECK NAILS (COLLATED AVAILABLE)



316 PAINTED TRIM SCREWS



305 & 316 TRIM SCREWS

CONTENTS

DRIVE™ SYSTEMS	4
CLIPDRIVE	4
UNIVERSAL DECK CLIPS	6
DRIVE	8
COLLATED SCREWS	10
DRIVE SYSTEM ACCESSORIES	12
MARKSMAN SYSTEM	14
MARKSMAN TOOLS	15
EDGE SCREWS	16
MARKSMAN ACCESSORIES	18
LEVER®	20
EXTERIOR FASTENERS	22
DECK	23
COMPOSITE	25
TRIM	28
STRUCTURAL	32
EXTERIOR ACCESSORIES	40
STAINLESS STEEL FASTENERS	42
DECK SCREWS	44
COMPOSITE SCREWS	46
EDGE SCREWS	48
TRIM SCREWS	49
BITS	52
HAND DRIVE NAILS	53
COLLATED NAILS	54
COATINGS INFORMATION	56
FASTENER & TOOL SELECTOR	58



CLIPDRIVE

STAND UP FASTENING TOOL FOR CAMO® UNIVERSAL DECK CLIPS

The Better Way to Fasten CAMO Universal Deck Clips.

Stand tall, target screws easily, and drive clips up to 5X faster with CAMO ClipDRIVE™, the contractor-grade tool designed to give you the best experience fastening grooved decking.

STAND-UP DECK CLIP FASTENING SYSTEM



TOOL

(p. 5)

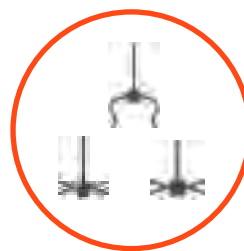

FASTENERS

(p. 6-7)



ClipDRIVE™

- Install grooved decking up to 5X faster
- For use with CAMO® Universal Deck Clips on leading grooved deck boards
- Attaches to your drill, features an adjustable handle, and has a weighted nose for easy screw targeting
- Ergonomically designed to be easy on the body and reduce fatigue on the job
- CAMO Universal Deck Clips and the ClipDRIVE are backed by a CAMO Warranty



SKU#	DESCRIPTION	QTY	CT./MASTER
0345065	ClipDRIVE	1	1

FASTEN WITH THE ClipDRIVE

BUILD YOUR DECK UP TO 5X FASTER USING CAMO LEVER, CLIPS AND ClipDRIVE TOGETHER.

(p.20)

CLIP

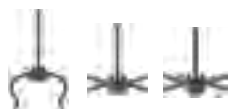
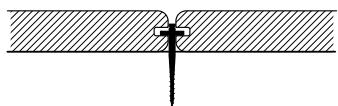

Use CAMO Universal Deck Clips (p. 6-7)

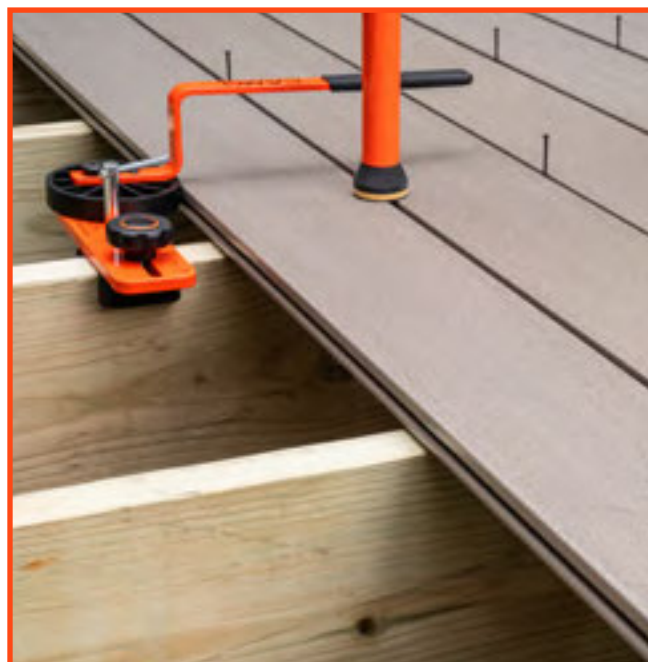



UNIVERSAL DECK CLIPS

CAMO® deck clips make installing grooved decking on wood or metal joists easy for everyone.

These hidden deck clips are designed and warranted for use with leading grooved deck boards and result in a beautiful fastener-free surface that you can install in half the time of other hidden fasteners. Fasten EDGE®, EDGEX®, and EDGEXMETAL® Clips by hand with the included NEVER-MISS™ Guide or standing up with ClipDRIVE™ and DRIVE™.

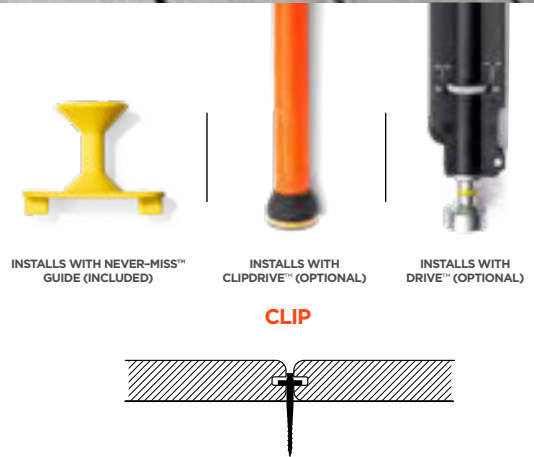

STARTER

- Secure the first and last board to achieve a completely fastener-free deck surface on wood joists
- Designed for use with leading grooved deck boards
- Screw tip bites into joist quickly
- Versatile clip can also be used as an L-bracket



SKU#	DESCRIPTION	COVERAGE	QTY	DRIVER BIT	CT./MASTER
0344087	STARTER Clip - For Wood Joists	30 lineal ft. (9m)	25	--	6



EDGE®

- 90° deck patterns on wood joists
- One-pass fasteners—clip sits in place on the joist until you're ready to fasten
- Clip creates 3/16 in. (4.7mm) spacing
- Gusset holds boards down
- Fasten with included NEVER-MISS™ Guide or while standing up with the CAMO ClipDRIVE™ or DRIVE™
- 304 stainless gusset, 410 stainless screw, nylon plastic spacer body



SKU#	DESCRIPTION	QTY	COVERAGE	DRIVER BIT	CT./MASTER
0344354	EDGE Clip - 90° Deck Pattern on Wood Joists	90	50 sq. ft. (4.64m ²)	1 - T-15	4
0344359		450	250 sq. ft. (23.22m ²)	2 - T-15	1
0344356		900	500 sq. ft. (46.45m ²)	2 - T-15	1



EDGEX®

- Any deck pattern on wood joists
- One-pass fasteners—clip sits in the groove of the board until you're ready to fasten
- Clip body creates 3/16 in. (4.7mm) spacing
- Gusset holds boards down
- Fasten with included NEVER-MISS™ Guide or while standing up with the CAMO ClipDRIVE™ or DRIVE™
- 304 stainless gusset, 410 stainless screw, nylon plastic spacer body



SKU#	DESCRIPTION	QTY	COVERAGE	DRIVER BIT	CT./MASTER
0344554	EDGEX Clip - Any Deck Pattern on Wood Joists	90	50 sq. ft. (4.64m ²)	1 - T-15	4
0344559		450	250 sq. ft. (23.22m ²)	2 - T-15	1
0344556		900	500 sq. ft. (46.45m ²)	2 - T-15	1



EDGEXMETAL®

- Any deck pattern on 14-18GA metal joists
- One-pass fasteners—clip sits in the groove of the board until you're ready to fasten
- Clip body creates 3/16 in. (4.7mm) spacing
- Gusset holds boards down
- Fasten with included NEVER-MISS™ Guide or while standing up with the CAMO ClipDRIVE™ or DRIVE™
- 304 stainless gusset, 410 stainless screw, nylon plastic spacer body



SKU#	DESCRIPTION	QTY	COVERAGE	DRIVER BIT	CT./MASTER
0344574	EDGEXMETAL Clip 14-18GA Metal Framing	90	50 sq. ft. (4.64m ²)	1 - T-15	4
0344579		450	250 sq. ft. (23.22m ²)	2 - T-15	1



DRIVE[™]

STAND UP FASTENING TOOL FOR CAMO COLLATED EDGE SCREWS, FACE SCREWS AND DECK CLIPS

Stand up, save your back and knees, and save your time with the award-winning CAMO[®] DRIVE[™] tool.

Fasten square and grooved deck boards with the CAMO DRIVE tool, featuring three interchangeable nose pieces to install Collated Edge and Face Screws and CAMO Universal Deck Clips.



TOOL
(p. 9)



FASTENERS
(p. 6-7 & 10-11)



ACCESSORIES
(p. 12)

STAND-UP DECK FASTENING SYSTEM



DRIVE™

- Attaches to your drill
- Use with CAMO Collated Edge Screws, Collated Face Screws, and CAMO Universal Deck Clips
- Fasten square® pressure treated, KDAT, cedar, redwood, composite, PVC, and grooved deck boards
- Easy to use, featuring a reversible handle and quick-change nose pieces
- Stand-up fastening allows for fast installations that are easy on the body



SKU#	DESCRIPTION	QTY	CT./MASTER
0345060	DRIVE	1	1

THREE WAYS TO FASTEN WITH DRIVE

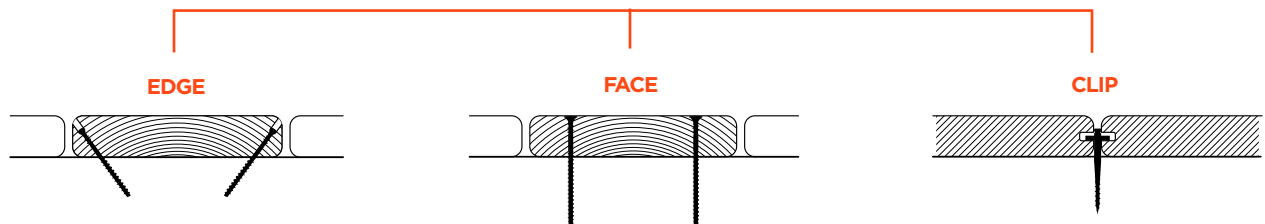

Use the Edge nose piece with CAMO Collated Edge Screws (p. 11)



Use the Face nose piece with CAMO Collated Face Screws (p. 11)



Use the Clip nose piece with CAMO Universal Deck Clips (p. 6-7)

*For most square decking installs, we recommend using secondary spacers to allow for expansion, contraction, and drainage.



COLLATED SCREWS

CAMO Collated screws are exclusively designed for use with the DRIVE tool.

Each fastener was intentionally created and collated for peak performance in its given application. Collated screws are available in 1000 ct. quantities, which cover 285 sq. ft. (26.48 m²) and come with their corresponding driver bits: T-15 for Edge Screws and T-20 for Face Screws.



FOR EXCLUSIVE USE WITH DRIVE TOOL

EDGE

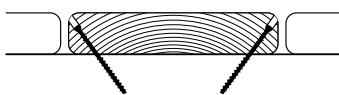

FACE

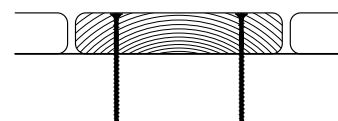

FOR USE WITH T-15 BIT + EDGE NOSE PIECE

FOR USE WITH T-20 BIT + FACE NOSE PIECE

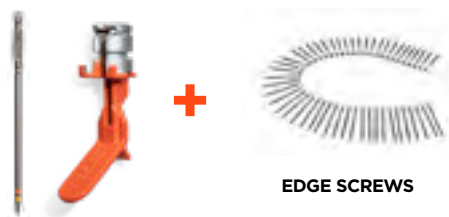

EDGE SCREWS



FACE SCREWS FOR PRESSURE TREATED AND COMPOSITE



COLLATED EDGE SCREWS (WOOD & NON-CAPPED COMPOSITE)

- For use with DRIVE and Edge nose piece (orange)
- 2-3/8 in. (60.3 mm) screw secures 1-1-1/2 in. (25.4-38.1mm) thick pressure treated, cedar, redwood, uncapped composite, and PVC deck boards
- Rake tip augers material out reducing splitting and cracking, trimhead reduces visibility
- T-15 Star Drive limits cam-outs



SKU#	DESCRIPTION	COATING/ALLOY	SIZE	QTY	DRIVER BIT	CT/MASTER
0395010	Collated Edge Screws for DRIVE	PROTECH	2-3/8 in. (60.3mm)	1000	2 - T-15	1
0395020S		316 Stainless Steel	2-3/8 in. (60.3mm)	1000	2 - T-15	1



COLLATED FACE SCREWS (PRESSURE TREATED)

- For use with DRIVE and Face nose piece (black)
- 3 in. (76.2mm) screw secures pressure treated boards up to 1-1/2 in. (38.1 mm) thick
- Rake tip augers material out, reducing splitting, and buglehead draws the board tight
- T-20 Star Drive limits cam-outs



SKU#	DESCRIPTION	COLOR	SIZE	QTY	DRIVER BIT	CT/MASTER
0395040	Collated Wood Face Screws for DRIVE - PROTECH	Green	3 in. x #10 (76.2mm)	1000	2 - T-20	1
0395042		Tan	3 in. x #10 (76.2mm)	1000	2 - T-20	1
0395047		Red	3 in. x #10 (76.2mm)	1000	2 - T-20	1



COLLATED FACE SCREWS (COMPOSITE)

- For use with DRIVE and Face nose piece (black)
- 2-1/2 in. (63.5mm) screw secures 1 in. (25.4mm) thick composite and PVC deck boards
- Slash point drives quickly, cutting lead edge creates a flush finish
- T-20 Star Drive limits cam-outs



COLOR MATCHER
Use the color matcher on camofasteners.com to find the right color for your board.



SKU#	DESCRIPTION	COLOR	SIZE	QTY	DRIVER BIT	CT/MASTER
0395050	Collated Composite Face Screws for DRIVE - PROTECH	Brown	2-1/2 in. x #10 (63.5mm)	1000	2 - T-20	1
0395060		Grey	2-1/2 in. x #10 (63.5mm)	1000	2 - T-20	1
0395070		Tan	2-1/2 in. x #10 (63.5mm)	1000	2 - T-20	1
0395080	Collated Composite Face Screws for DRIVE- 305 Stainless Steel	Bright	2-1/2 in. x #10 (63.5mm)	1000	2 - T-20	1

DRIVE SYSTEM ACCESSORIES

Driver bits are engineered specifically for use with the CAMO DRIVE and ClipDRIVE tools. The bits engage quickly and easily with the screw heads with reduced cam-outs, and are color-coded with a band for quick identification—orange and yellow for Edge and Clip fastening, black for Face fastening.

T-15 BIT



- For use with CAMO DRIVE for Edge or Clip fastening and the CAMO ClipDRIVE
- 6.25 in. (160mm) long
- T-15 Star Drive



SKU#	DESCRIPTION	QTY	CT./MASTER
0395715	T-15 Bit Replacement	2/pk	4

T-20 BIT



- For use with CAMO DRIVE for Face fastening
- 6.25 in. (160mm) long
- T-20 Star Drive



SKU#	DESCRIPTION	QTY	CT./MASTER
0395720	T-20 Bit Replacement	2/pk	4

NOSE PIECES



- Replacement nose pieces for use with CAMO DRIVE
- Edge (orange) for fastening Collated Edge Screws
- Clip (yellow-banded silver) for fastening Universal Deck Clips
- Face (black) for fastening Collated Composite and Wood Face Screws



SKU#	DESCRIPTION	QTY
0395801	Replacement Edge Nose Piece	1
0395805	Replacement Clip Nose Piece	1
0395803	Replacement Face Nose Piece	1





MARKSMAN SYSTEM

Achieve a fastener-free surface on square decking with this easy and affordable hidden fastening system.

MARKSMAN Tools automatically establish spacing between boards and direct CAMO Edge Screws into the edge of the board, leaving a smooth deck surface. Plus, the MARKSMAN System is backed by a CAMO warranty for use in leading deck boards.

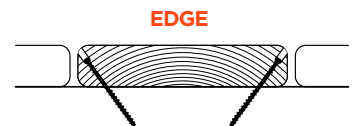

HIDDEN FASTENER SYSTEM



TOOLS

p. 15



FASTENERS

p. 16-17



ACCESSORIES

p. 18



MARKSMAN PRO®

- For use with CAMO Edge Screws on square composite, PVC, capped composite, cedar, redwood, hardwood, and KDAT deck boards
- Fits most 5-¼ in. (133mm) to 5-¾ in. (146mm) boards
- Creates 3/16 in. (4.7mm) spacing



SKU#	DESCRIPTION	QTY	CT./MASTER
0345001	MARKSMAN Pro	1	6



MARKSMAN PRO®-X1

- For use with CAMO Edge Screws on pressure treated deck boards
- Fits most 5-¼ in. (133mm) to 5-¾ in. (146mm) boards
- Creates 1/16 in. (1.59mm) spacing



SKU#	DESCRIPTION	QTY	CT./MASTER
0345002	MARKSMAN Pro - X1	1	6



MARKSMAN PRO®-NB

- For use with CAMO Edge Screws on square composite, PVC, capped composite, cedar, redwood, hardwood, and KDAT narrow deck boards
- Fits most 3-¼ in. (83mm) to 5 in. (127mm) boards
- Creates 3/16 in. (4.7mm) spacing



SKU#	DESCRIPTION	QTY	CT./MASTER
0345015	MARKSMAN Pro - NB	1	6



MARKSMAN® EDGE

- For use with CAMO Edge Screws on pressure treated deck boards
- Single-shot tool attaches to your drill
- Tool leaves no spacing between boards



SKU#	DESCRIPTION	QTY	CT./MASTER
0345020	MARKSMAN Edge	1	6



EDGE SCREWS

The Best Deck Screws You'll Never See.

CAMO Edge Screws are an innovative, easy-to-install hidden fastener that delivers a high-end look at an affordable price. They are for exclusive use with MARKSMAN Pro tools. Edge Screws feature a patented rake tip that augers material out as you drive to reduce board splitting and a trimhead to reduce visibility. They are available in CAMO's proprietary PROTECH coating and 316 Stainless Steel.

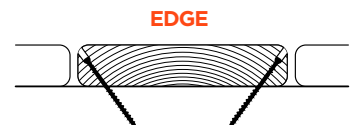

PROTECH COATED

PROTECH is our coating that is suitable for use with pressure treated lumber, PVC, composite, and capped composite deck boards in inland environments that face regular exposure to the elements.



316 STAINLESS STEEL MARINE GRADE

316 Stainless Steel is the best fastener for any project and is required for installations in highly corrosive areas like structures that are near saltwater, or that will be exposed to harsh chemicals like chlorine, wood strippers, or ice melt.

DECK BOARD MATERIAL	RECOMMENDED CAMO EDGE SCREW
Pressure Treated Lumber	Stainless Steel or PROTECH Coated
Composite	Stainless Steel or PROTECH Coated
Capped Composite	Stainless Steel or PROTECH Coated (with pre-drilling)
PVC	Stainless Steel or PROTECH Coated
Cedar	Stainless Steel Required
Redwood	Stainless Steel Required
Hardwood or Imported Hardwood	Stainless Steel Required (with pre-drilling)

EDGE SCREWS

- For use with all square deck boards, including pressure treated, composite, PVC, capped composite, cedar, redwood, and hardwood
- Features a patented rake tip that augers material out as they're driven, reducing the potential for splitting and cracking*
- T-15 Star Drive offers best connection, reducing cam-outs and stripped screws
- Trimhead reduces visibility on the edge of the board
- Available in PROTECH coating and 316 Stainless Steel



*Pre-drilling is required for hardwoods and capped composites

PROTECH COATED



SKU#	SIZE	QTY	COVERAGE	DRIVER BIT	CT./MASTER
0345120	1-7/8 in. (47.6mm) x #7	100	30 sq. ft. (2.79m ²)	--	12
0345128		350	100 sq. ft. (9.29m ²)	1 - T-15	12
0345124		700	200 sq. ft. (18.58m ²)	2 - T-15	4
0345119		1750	500 sq. ft. (46.45m ²)	2 - T-15	4
0345140	2-3/8 in. (60.3mm) x #7	100	30 sq. ft. (2.79m ²)	--	12
0345148		350	100 sq. ft. (9.29m ²)	1 - T-15	12
0345144		700	200 sq. ft. (18.58m ²)	2 - T-15	4
0345139		1750	500 sq. ft. (46.45m ²)	2 - T-15	4

316 STAINLESS STEEL MARINE GRADE



SKU#	SIZE	QTY	COVERAGE	DRIVER BIT	CT./MASTER
0345220S	1-7/8 in. (47.6mm) x #7	100	30 sq. ft. (2.79m ²)	--	12
0345228S		350	100 sq. ft. (9.29m ²)	1 - T-15	12
0345224S		700	200 sq. ft. (18.58m ²)	2 - T-15	4
0345219S		1750	500 sq. ft. (46.45m ²)	2 - T-15	1
0345240S	2-3/8 in. (60.3mm) x #7	100	30 sq. ft. (2.79m ²)	--	12
0345248S		350	100 sq. ft. (9.29m ²)	1 - T-15	12
0345244S		700	200 sq. ft. (18.58m ²)	2 - T-15	4
0345239S		1750	500 sq. ft. (46.45m ²)	2 - T-15	1

MARKSMAN ACCESSORIES

Driver Bits are engineered specifically for use with CAMO Edge Screws and MARKSMAN Pro® tools. The built-in shoulder sets automatic depth of drive for maximum holding power, and prevents over-driving the screw.

DRIVER BITS SQUARE BOARDS



- For use with MARKSMAN Pro® tools and Edge Screws
- 3 in. (76.2 mm) long
- T-15 Star Drive



SKU#	DESCRIPTION	QTY	CT./MASTER
0345099	Driver Bit	2/pk	10

DRIVER BITS GROOVED BOARDS



- For use with MARKSMAN Pro® tools and Edge Screws
- 3 in. (76.2 mm) long
- T-15 Star Drive



SKU#	DESCRIPTION	QTY	CT./MASTER
0345089	Driver Bit for Grooved Board	2/pk	10

PRE-DRILL BITS



- For use with MARKSMAN Pro® tools
- Pre-drilling is required for capped composite and hardwood
- 3-5/8 in. (92mm) long



SKU#	DESCRIPTION	QTY	CT./MASTER
0345035	Pre-Drill Bit	2/pk	10





LEVER[®]

BOARD BENDING AND LOCKING TOOL

Build a better deck by yourself with LEVER[®], the one-turn tool that locks-in rows of boards and clips and straightens warped boards.



- Speeds up grooved deck installs—locks-in rows of boards and clips before fastening
- Strong enough to straighten any warped board
- Easily adjusts to wood and metal joists 1-1/2–3 in. wide for jobsite versatility
- Multi-directional lever locks in one turn



SKU#	DESCRIPTION	QTY	CT./MASTER
0345070	LEVER	1	4



LOCKS BOARDS & CLIPS

Use 2-4 LEVER tools across the length of the deck for the best clip installation experience with consistent spacing.

BENDS WARPED BOARDS

One LEVER is strong enough to straighten out warped pressure treated and hardwood boards in one turn.



ANY JOIST MATERIAL

Works on wood and metal joists



ANY JOIST WIDTH

Adjusts to joists 1-½ to 3 in. wide



ANY BOARD TYPE

Straightens and locks any board at any angle

ONE TOOL FOR EVERY JOB









EXTERIOR FASTENERS

CAMO offers a high-quality line of exterior fasteners that deliver on reliability no matter the project.

CAMO fasteners start fast, hold strong, and create long-lasting connections. Our fasteners are coated with high-performance exterior-grade coatings, and can be used on interior projects as well. Our comprehensive line includes Deck, Composite, Trim, and new code-compliant Structural screws along with a line of marine-grade Stainless Steel fasteners. Make CAMO your one-stop shop for all your performance screw needs.

RECOMMENDED APPLICATIONS FOR EACH SCREW TYPE

 DECK	 COMPOSITE	 TRIM	 NAILS	 NEW CODE-COMPLIANT STRUCTURAL
<ul style="list-style-type: none"> • Wood decking projects • Fences • Any exterior wood-to-wood connection <p>(p. 23-24)</p>	<ul style="list-style-type: none"> • Composite decking projects • PVC decking projects <p>(p. 24-27)</p>	<ul style="list-style-type: none"> • Wood and PVC Decking • Exterior trim • Deck rails • Balusters • Fences <p>(p. 28-31)</p>	<ul style="list-style-type: none"> • Wood patios • Wood decks • Other exterior wood to wood connections in corrosive environments <p>(p. 55-56)</p>	 <ul style="list-style-type: none"> • Truss • Multi-Ply • Multi-Ply + Ledger • Framing • Multi-Purpose <p>(p. 32-43)</p>

CAMO Exterior Fasteners also for Interior use

STAINLESS STEEL

CAMO offers a comprehensive line of Stainless Steel screws and nails to help you build a better deck in corrosive environments.

305 STAINLESS STEEL

Great corrosion resistance for most inland exterior projects.

316SS MARINE GRADE

Best corrosion resistance for projects in highly corrosive environments.

DECK SCREWS

- For any wood-to-wood connection
- Type 17 slash point starts fast and reduces splitting
- Buglehead and 2/3 thread design draw the board tight
- Star Drive provides more points of contact, reducing cam-outs
- Available in green and tan PROTECH coating to blend into wood surfaces, and 305 Stainless Steel and 316 Stainless Steel for maximum corrosion resistance

PROTECH COATED Deck Screws



GREEN SKU#	TAN SKU#	SIZE	QTY	COVERAGE	DRIVER BIT	CT./MASTER
0341070	0356070	1-¼ in. (31.8mm) x #7	100	30 sq. ft. (2.79m ²)	1 - T-20	12
0341074	0356074		350	100 sq. ft. (9.29m ²)	1 - T-20	4
0341100	0356100	1-⅝ in. (41.3mm) x #8	100	30 sq. ft. (2.79m ²)	1 - T-20	12
0341104	0356104		350	100 sq. ft. (9.29m ²)	1 - T-20	4
0341109	0356109		1750	500 sq. ft. (46.45m ²)	2 - T-20	1
0341130	0356130	2 in. (50.8mm) x #8	100	30 sq. ft. (2.79m ²)	1 - T-20	12
0341134	0356134		350	100 sq. ft. (9.29m ²)	1 - T-20	4
0341139	0356139		1750	500 sq. ft. (46.45m ²)	2 - T-20	1
0341150	0356150	2-½ in. (63.5mm) x #9	100	30 sq. ft. (2.79m ²)	1 - T-25	12
0341154	0356154		350	100 sq. ft. (9.29m ²)	1 - T-25	4
0341159	0356159		1750	500 sq. ft. (46.45m ²)	2 - T-25	1
0341170	0356170	3 in. (76.2mm) x #9	100	30 sq. ft. (2.79m ²)	1 - T-25	12
0341174	0356174		350	100 sq. ft. (9.29m ²)	1 - T-25	4
0341179	0356179		1750	500 sq. ft. (46.45m ²)	2 - T-25	1
0341190	0356190	3-½ in. (88.9mm) x #10	50	15 sq. ft. (1.39m ²)	1 - T-25	12
0341194	0356194		250	70 sq. ft. (6.5m ²)	1 - T-25	4
0341199	0356199		1350	385 sq. ft. (35.77m ²)	2 - T-25	1
0341200	0356200	4 in. (101.6mm) x #10	50	15 sq. ft. (1.39m ²)	1 - T-25	12
0341204	0356204		250	70 sq. ft. (6.5m ²)	1 - T-25	4
0341209	0356209		1350	385 sq. ft. (35.77m ²)	2 - T-25	1
0341220	0356220	5 in. (127mm) x #12	30	9 sq. ft. (0.84m ²)	1 - T-25	10
0341224	0356224		100	30 sq. ft. (2.79m ²)	1 - T-25	4
0341229	0356229		250	70 sq. ft. (6.5m ²)	1 - T-25	1
0341240	0356240	6 in. (152.4mm) x #12	30	9 sq. ft. (0.84m ²)	1 - T-25	10
0341244	0356224		100	30 sq. ft. (2.79m ²)	1 - T-25	4
0341249	0356249		250	70 sq. ft. (6.5m ²)	1 - T-25	1

For more information on coatings, go to pg. 56

305 STAINLESS STEEL

Deck Screws



SKU#	SIZE	QTY	COVERAGE	DRIVER BIT	CT./MASTER
0348100*	1-5/8 in. (41.3mm) x #8	100	30 sq. ft. (2.79m ²)	1 - T-25	12
0348104*		350	100 sq. ft. (9.29m ²)	1 - T-25	4
0348109*		1750	500 sq. ft. (46.45m ²)	2 - T-25	1
0348130*	2 in. (50.8mm) x #8	100	30 sq. ft. (2.79m ²)	1 - T-25	12
0348134*		350	100 sq. ft. (9.29m ²)	1 - T-25	4
0348139*		1750	500 sq. ft. (46.45m ²)	2 - T-25	1
0348150	2-1/2 in. (63.5mm) x #10	100	30 sq. ft. (2.79m ²)	1 - T-25	12
0348154		350	100 sq. ft. (9.29m ²)	1 - T-25	4
0348159		1750	500 sq. ft. (46.45m ²)	2 - T-25	1
0348170	3 in. (76.2mm) x #10	100	30 sq. ft. (2.79m ²)	1 - T-25	12
0348174		350	100 sq. ft. (9.29m ²)	1 - T-25	4
0348179		1750	500 sq. ft. (46.45m ²)	2 - T-25	1
0348190*	3-1/2 in. (88.9mm) x #10	50	30 sq. ft. (2.79m ²)	1 - T-25	12
0348194*		250	100 sq. ft. (9.29m ²)	1 - T-25	4
0348199*		1350	500 sq. ft. (46.45m ²)	2 - T-25	1
0348200*	4 in. (101.6mm) x #10	50	30 sq. ft. (2.79m ²)	1 - T-25	12
0348204*		250	100 sq. ft. (9.29m ²)	1 - T-25	4
0348209*		1350	500 sq. ft. (46.45m ²)	2 - T-25	1

316 STAINLESS STEEL MARINE GRADE

Deck Screws



SKU#	SIZE	QTY	COVERAGE	DRIVER BIT	CT./MASTER
0348100S	1-5/8 in. (41.3mm) x #9	100	30 sq. ft. (2.79m ²)	1 - T-25	12
0348104S		350	100 sq. ft. (9.29m ²)	1 - T-25	4
0348130S	2 in. (50.8mm) x #9	100	30 sq. ft. (2.79m ²)	1 - T-25	12
0348134S		350	100 sq. ft. (9.29m ²)	1 - T-25	4
0348139S		1750	500 sq. ft. (46.45m ²)	2 - T-25	1
0348150S	2-1/2 in. (63.5mm) x #10	100	30 sq. ft. (2.79m ²)	1 - T-25	12
0348154S		350	100 sq. ft. (9.29m ²)	1 - T-25	4
0348159S		1750	500 sq. ft. (46.45m ²)	2 - T-25	1
0348170S	3 in. (76.2mm) x #10	100	30 sq. ft. (2.79m ²)	1 - T-25	12
0348174S		350	100 sq. ft. (9.29m ²)	1 - T-25	4
0348179S		1750	500 sq. ft. (46.45m ²)	2 - T-25	1
0348190S	3-1/2 in. (88.9mm) x #10	50	15 sq. ft. (1.39m ²)	1 - T-25	12
0348194S		250	70 sq. ft. (6.5m ²)	1 - T-25	4
0348199S		1350	385 sq. ft. (35.77m ²)	2 - T-25	1

For more information on coatings, go to pg. 56

COMPOSITE SCREWS

- Color-matched screws for composite and PVC decking projects
- Type 99 double slash point augers board material out for fast driving
- Trilobular shank reduces torque and prevents mushrooming
- Reverse thread at top increases pull-down power while cutting lead edge creates a flush finish
- T-20 Star Drive provides more points of contact, reducing cam-outs and limiting bit wear
- Available in PROTECH coating and 316 Stainless Steel for maximum corrosion resistance



COLOR MATCHER

Our Composite screws are available in painted finishes to match popular deck boards. Use the color matcher on camofasteners.com to find the right color for your board.

PROTECH COATED Composite Screws



SKU#	SIZE	QTY	COVERAGE	DRIVER BIT	CT./MASTER	COLOR
0349250	2-½ in. (63.5mm) x #10	100	30 sq. ft. (2.79m ²)	1 - T-20	12	Brown
0349254		350	100 sq. ft. (9.29m ²)	1 - T-20	4	
0349259		1750	500 sq. ft. (46.45m ²)	2 - T-20	1	
0349350	2-½ in. (63.5mm) x #10	100	30 sq. ft. (2.79m ²)	1 - T-20	12	Cedar
0349354		350	100 sq. ft. (9.29m ²)	1 - T-20	4	
0349359		1750	500 sq. ft. (46.45m ²)	2 - T-20	1	
0349050	2-½ in. (63.5mm) x #10	100	30 sq. ft. (2.79m ²)	1 - T-20	12	Dark Brown
0349054		350	100 sq. ft. (9.29m ²)	1 - T-20	4	
0349059		1750	500 sq. ft. (46.45m ²)	2 - T-20	1	

For more information on coatings, go to pg. 56

PROTECH COATED Composite Screws



SKU#	SIZE	QTY	COVERAGE	DRIVER BIT	CT./MASTER	COLOR	
0349450	2-½ in. (63.5mm) x #10	100	30 sq. ft. (2.79m ²)	1 - T-20	12	Grey	
0349454		350	100 sq. ft. (9.29m ²)	1 - T-20	4		
0349459		1750	500 sq. ft. (46.45m ²)	2 - T-20	1		
0349550	2-½ in. (63.5mm) x #10	100	30 sq. ft. (2.79m ²)	1 - T-20	12	Redwood	
0349554		350	100 sq. ft. (9.29m ²)	1 - T-20	4		
0349559		1750	500 sq. ft. (46.45m ²)	2 - T-20	1		
0349750	2-½ in. (63.5mm) x #10	100	30 sq. ft. (2.79m ²)	1 - T-20	12	Sand	
0349754		350	100 sq. ft. (9.29m ²)	1 - T-20	4		
0349759		1750	500 sq. ft. (46.45m ²)	2 - T-20	1		
0349950	2-½ in. (63.5mm) x #10	100	30 sq. ft. (2.79m ²)	1 - T-20	12	Stone Grey	
0349954		350	100 sq. ft. (9.29m ²)	1 - T-20	4		
0349959		1750	500 sq. ft. (46.45m ²)	2 - T-20	1		
0349150	2-½ in. (63.5mm) x #10	100	30 sq. ft. (2.79m ²)	1 - T-20	12	Tan	
0349154		350	100 sq. ft. (9.29m ²)	1 - T-20	4		
0349159		1750	500 sq. ft. (46.45m ²)	2 - T-20	1		
0349850	2-½ in. (63.5mm) x #10	100	30 sq. ft. (2.79m ²)	1 - T-20	12	Winchester	
0349854		350	100 sq. ft. (9.29m ²)	1 - T-20	4		
0349859		1750	500 sq. ft. (46.45m ²)	2 - T-20	1		
0349000G	2-½ in. (63.5mm) x #10	100	30 sq. ft. (2.79m ²)	1 - T-20	12	Dark Grey	
0349004G		350	100 sq. ft. (9.29m ²)	1 - T-20	4		
0349009G		1750	500 sq. ft. (46.45m ²)	2 - T-20	1		

For more information on coatings, go to pg. 56

316 STAINLESS STEEL MARINE GRADE

Composite Screws



SKU#	SIZE	QTY	COVERAGE	DRIVER BIT	CT./MASTER	COLOR	
0367158BS	2-½ in. (63.5mm) x #10	350	100 sq. ft. (9.29m ²)	1 - T-20	4	Brown	
0367159BS		1750	500 sq. ft. (46.45m ²)	2 - T-20	1		
0367158CS	2-½ in. (63.5mm) x #10	350	100 sq. ft. (9.29m ²)	1 - T-20	4	Cedar	
0367159CS		1750	500 sq. ft. (46.45m ²)	2 - T-20	1		
0367158ES	2-½ in. (63.5mm) x #10	350	100 sq. ft. (9.29m ²)	1 - T-20	4	Grey	
0367159ES		1750	500 sq. ft. (46.45m ²)	2 - T-20	1		
0367158DS	2-½ in. (63.5mm) x #10	350	100 sq. ft. (9.29m ²)	1 - T-20	4	Dark Brown	
0367159DS		1750	500 sq. ft. (46.45m ²)	2 - T-20	1		
0367158NS	2-½ in. (63.5mm) x #10	350	100 sq. ft. (9.29m ²)	1 - T-20	4	Stone Grey	
0367159NS		1750	500 sq. ft. (46.45m ²)	2 - T-20	1		
0367158RS	2-½ in. (63.5mm) x #10	350	100 sq. ft. (9.29m ²)	1 - T-20	4	Redwood	
0367159RS		1750	500 sq. ft. (46.45m ²)	2 - T-20	1		
0367158SS	2-½ in. (63.5mm) x #10	350	100 sq. ft. (9.29m ²)	1 - T-20	4	Sand	
0367159SS		1750	500 sq. ft. (46.45m ²)	2 - T-20	1		
0367158TS	2-½ in. (63.5mm) x #10	350	100 sq. ft. (9.29m ²)	1 - T-20	4	Tan	
0367159TS		1750	500 sq. ft. (46.45m ²)	2 - T-20	1		
0367158WS	2-½ in. (63.5mm) x #10	350	100 sq. ft. (9.29m ²)	1 - T-20	4	Winchester	
0367159WS		1750	500 sq. ft. (46.45m ²)	2 - T-20	1		
0367158GS	2-½ in. (63.5mm) x #10	350	100 sq. ft. (9.29m ²)	1 - T-20	4	Dark Grey	
0367159GS		1750	500 sq. ft. (46.45m ²)	2 - T-20	1		
0367158S	2-½ in. (63.5mm) x #10	350	100 sq. ft. (9.29m ²)	1 - T-20	4	Bright	
0367159S		1750	500 sq. ft. (46.45m ²)	2 - T-20	1		

TRIM SCREWS

- For exterior deck, trim, and finish applications with wood and PVC
- Type 17 slash point starts fast with no pre-drilling
- Trimhead screw reduces visibility in finish projects
- T-15 Star Drive provides more points of contact, reducing cam-outs and limiting bit wear
- Available in green PROTECH coating to blend into wood surfaces, bright 305 and 316 Stainless Steel, and painted 316 Stainless Steel

PROTECH COATED Trim Screws



SKU#	SIZE	QTY	DRIVER BIT	CT./MASTER	HEAD
0346100	1-5/8 in. (41.3mm) x #7	100	1 - T-15	12	
0346104		350	1 - T-15	4	
0346130	2 in. (50.8mm) x #7	100	1 - T-15	12	
0346134		350	1 - T-15	4	
0346150	2-1/2 in. (63.5mm) x #7	100	1 - T-15	12	
0346154		350	1 - T-15	4	
0346159		1750	1 - T-15	1	
0346170	3 in. (76.2mm) x #7	100	1 - T-15	12	
0346174		350	1 - T-15	4	
0346190	3-1/2 in. (88.9mm) x #8	100	1 - T-15	12	
0346194		350	1 - T-15	4	

For more information on coatings, go to pg. 56

305 STAINLESS STEEL

Trim Screws



SKU#	SIZE	QTY	DRIVER BIT	CT./MASTER
O350100*	1-5/8 in. (41.3mm) x #8	100	1 - T-15	12
O350104*		350	1 - T-15	4
O350130*	2 in. (50.8mm) x #8	100	1 - T-15	12
O350134*		350	1 - T-15	4
O350150*	2-1/2 in. (63.5mm) x #8	100	1 - T-15	12
O350154*		350	1 - T-15	4
O350170*	3 in. (76.2mm) x #8	100	1 - T-15	12
O350174*		350	1 - T-15	4

316 STAINLESS STEEL MARINE GRADE

Trim Screws



SKU#	SIZE	QTY	DRIVER BIT	CT./MASTER	HEAD
O350100S	1-5/8 in (41.3mm) x #8	100	1 - T-15	12	
O350104S		350	1 - T-15	4	
O350130S	2 in. (50.8mm) x #8	100	1 - T-15	12	
O350134S		350	1 - T-15	4	
O350150S	2-1/2 in. (63.5mm) x #8	100	1 - T-15	12	
O350154S		350	1 - T-15	4	
O350170S	3 in. (76.2mm) x #8	100	1 - T-15	12	
O350174S		350	1 - T-15	4	
O350190S	3-1/2 in. (88.9mm) x #8	100	1 - T-15	12	
O350194S		350	1 - T-15	4	

For more information on coatings, go to pg. 56

316 STAINLESS STEEL MARINE GRADE - PAINTED

Trim Screws



COLOR MATCHER

Our Stainless Steel Trim screws are available in painted finishes to match popular deck boards.

Use the color matcher on camofasteners.com to find the right color for your board.

SKU#	SIZE	QTY	DRIVER BIT	CT./MASTER	COLOR
0353000ES	1-5/8 in. (41.3mm) x #8	100	1 - T-15	12	Grey
0353004ES		350	1 - T-15	4	
0353009ES		1750	2 - T-15	1	
0353050ES	2-1/2 in. (63.5mm) x #8	100	1 - T-15	12	
0353054ES		350	1 - T-15	4	
0353059ES		1750	2 - T-15	1	
0353000RS	1-5/8 in. (41.3mm) x #8	100	1 - T-15	12	Redwood
0353004RS		350	1 - T-15	4	
0353009RS		1750	2 - T-15	1	
0353050RS	2-1/2 in. (63.5mm) x #8	100	1 - T-15	12	
0353054RS		350	1 - T-15	4	
0353059RS		1750	2 - T-15	1	
0353000WS	1-5/8 in. (41.3mm) x #8	100	1 - T-15	12	Winchester
0353004WS		350	1 - T-15	4	
0353009WS		1750	2 - T-15	1	
0353050WS	2-1/2 in. (63.5mm) x #8	100	1 - T-15	12	
0353054WS		350	1 - T-15	4	
0353059WS		1750	2 - T-15	1	
0353000NS	1-5/8 in. (41.3mm) x #8	100	1 - T-15	12	Stone Grey
0353004NS		350	1 - T-15	4	
0353009NS		1750	2 - T-15	1	
0353050NS	2-1/2 in. (63.5mm) x #8	100	1 - T-15	12	
0353054NS		350	1 - T-15	4	
0353059NS		1750	2 - T-15	1	
0353000GS	1-5/8 in. (41.3mm) x #8	100	1 - T-15	12	Dark Grey
0353004GS		350	1 - T-15	4	
0353009GS		1750	2 - T-15	1	
0353050GS	2-1/2 in. (63.5mm) x #8	100	1 - T-15	12	
0353054GS		350	1 - T-15	4	
0353059GS		1750	2 - T-15	1	

For more information on coatings, go to pg. 56



316 STAINLESS STEEL MARINE GRADE - PAINTED
Trim Screws

SKU#	SIZE	QTY	DRIVER BIT	CT./MASTER	COLOR	
0353000SS	1-5/8 in. (41.3mm) x #8	100	1 - T-15	12	Sand	
0353004SS		350	1 - T-15	4		
0353009SS		1750	2 - T-15	1		
0353050SS	2-1/2 in. (63.5mm) x #8	100	1 - T-15	12		
0353054SS		350	1 - T-15	4		
0353059SS		1750	2 - T-15	1		
0353000DS	1-5/8 in. (41.3mm) x #8	100	1 - T-15	12	Dark Brown	
0353004DS		350	1 - T-15	4		
0353009DS		1750	2 - T-15	1		
0353050DS	2-1/2 in. (63.5mm) x #8	100	1 - T-15	12		
0353054DS		350	1 - T-15	4		
0353059DS		1750	2 - T-15	1		
0353000CS	1-5/8 in. (41.3mm) x #8	100	1 - T-15	12	Cedar	
0353004CS		350	1 - T-15	4		
0353009CS		1750	2 - T-15	1		
0353050CS	2-1/2 in. (63.5mm) x #8	100	1 - T-15	12		
0353054CS		350	1 - T-15	4		
0353059CS		1750	2 - T-15	1		
0353100S	1-5/8 in. (41.3mm) x #8	100	1 - T-15	12	White	
0353104S		350	1 - T-15	4		
0353109S		1750	2 - T-15	1		
0353150S	2-1/2 in. (63.5mm) x #8	100	1 - T-15	12		
0353154S		350	1 - T-15	4		
0353159S		1750	2 - T-15	1		
0353000BS	1-5/8 in. (41.3mm) x #8	100	1 - T-15	12	Brown	
0353004BS		350	1 - T-15	4		
0353009BS		1750	2 - T-15	1		
0353050BS	2-1/2 in. (63.5mm) x #8	100	1 - T-15	12		
0353054BS		350	1 - T-15	4		
0353059BS		1750	2 - T-15	1		
0353000TS	1-5/8 in. (41.3mm) x #8	100	1 - T-15	12	Tan	
0353004TS		350	1 - T-15	4		
0353009TS		1750	2 - T-15	1		
0353050TS	2-1/2 in. (63.5mm) x #8	100	1 - T-15	12		
0353054TS		350	1 - T-15	4		
0353059TS		1750	2 - T-15	1		

For more information on coatings, go to pg. 56



STRUCTURAL SCREWS

CAMO offers a full line of high-performing, code-compliant structural screws for all your deck and framing needs. They are engineered to start fast, drive smooth, and hold strong. No pre-drilling required. Features our industry-leading propriety coating for superior corrosion resistance.

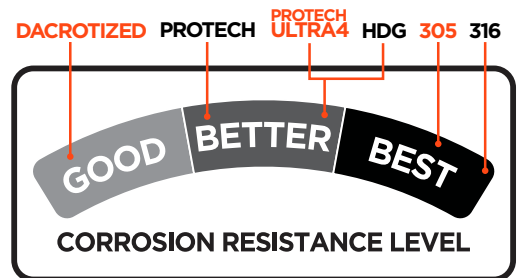

See pg. 56 for more information

DESIGN FEATURES

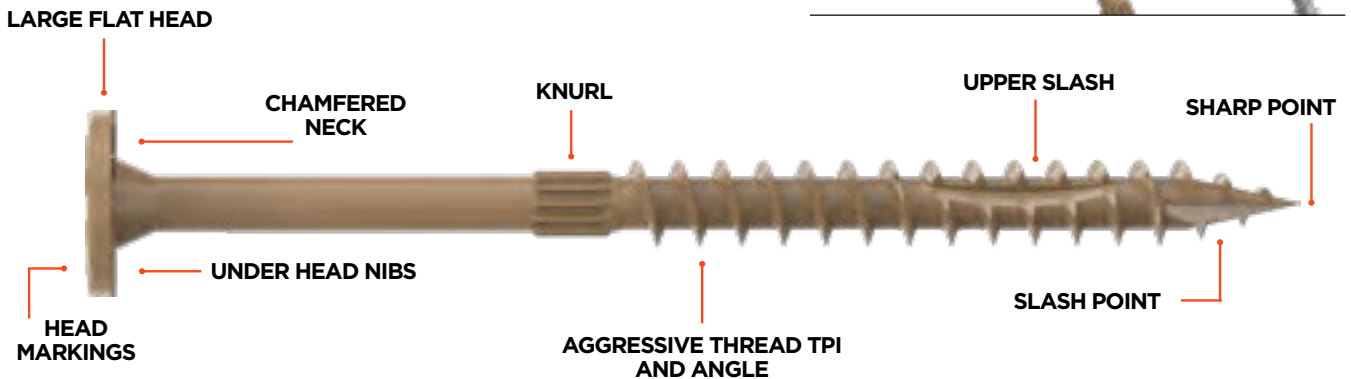

PROTECH[™] ULTRA 4

- TAN
- BLACK



CODE COMPLIANT

Our structural screws have been third-party tested, audited, and certified as IBC and IRC code-compliant by Dr J Engineering

- Our line covers all popular interior and exterior structural applications
- Engineered to start fast, drive smooth, and hold strong - no pre-drilling required
- Rigorously tested and approved for use with pressure-treated lumber
- IRC and IBC code compliant, State of Florida FL 41741
- Available in corrosion-resistant Hot Dip Galvanized and PROTECH Ultra 4 Coating

LEARN MORE ABOUT OUR STRUCTURAL SCREWS

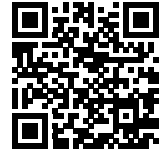

CODE COMPLIANT APPLICATIONS



TRUSS



LEDGER



MULTI-PLY



FRAMING

GENERAL CONSTRUCTION APPLICATIONS



DECK BLOCKING



POSTS



STRUCTURES







LANDSCAPING



GENERAL CONSTRUCTION

RECOMMENDED APPLICATIONS

 TRUSS	 MULTI-PLY + LEDGER	 FRAMING	 MULTI-PURPOSE
<ul style="list-style-type: none"> • Double top plate to truss or stud • Top plate to end wall truss (gable end) • Bottom plate to rim board • Beams to joist 	<ul style="list-style-type: none"> • Multi-ply wood headers and beams • Deck posts, beams, and handrails • Interior and exterior ledger boards • General construction projects 	<ul style="list-style-type: none"> • Wood-to-wood framing connections • Deck blocking • Interior and exterior projects 	<ul style="list-style-type: none"> • Garden and landscaping projects • Deck posts, beams, and handrails • General construction projects

TRUSS SCREWS (GUIDE INCLUDED)



NEW



- Code listed per DrJ TER No. 2102-01 and 2102-03 and State of Florida FL 41741
- For truss and rafter to top plate, stud to top plate, and deck joist to beam connections
- Replaces hurricane ties
- Fully threaded for maximum holding power
- Cylinder head easily countersinks for flush studs
- Sharp point starts fast with no pre-drilling, reducing drive time
- Slashes for reduced splitting
- T-30 Star Drive provides more points of contact, reducing cam-outs and limiting bit wear
- Includes easy-to-use truss screw guide
- CAMO PROTECH ULTRA 4 coating
- For interior and exterior use



SKU#	SIZE	QTY	DRIVER BIT	CT./MASTER
0372244	6 in. (152.4mm) x 0.156 in. (3.9mm)	50	1 - T-30	4
0372249		500	1 - T-30	1

TRUSS GUIDE

Fasten at the right angle every time with our hands-free truss guide, included in every pail.



DOUBLE TOP PLATE TO TRUSS



DOUBLE TOP PLATE TO TRUSS



BEAM TO TRUSS



BEAM TO JOIST



DOUBLE TOP PLATE TO STUD



BOTTOM PLATE TO RIM BOARD

FRAMING SCREWS

NEW



- Code listed per DrJ TER No. 2102-01 and State of Florida FL 41741
- For wood-to-wood framing connections, deck blocking, interior and exterior projects
- Replaces 8d, 10d, and 16d nails in interior and exterior framing applications
- Straight knurl reduces driving torque
- 6 nibs underhead help countersink screw
- Sharp point starts fast with no pre-drilling, reducing drive time
- Slashes for reduced splitting
- T-25 Star Drive provides more points of contact, reducing cam-outs and limiting bit wear
- CAMO PROTECH ULTRA 4 coating



SKU#	SIZE	QTY	DRIVER BIT	CT./MASTER
0355150	2-½ in. (63.5mm) x 0.160 in. (4.06mm)	50	1 - T-25	12
0355154		150	1 - T-25	4
0355159		1000	2 - T-25	1
0355170	3 in. (76.2mm) x 0.160 in. (4.06mm)	50	1 - T-25	12
0355174		150	1 - T-25	4
0355179		1000	2 - T-25	1

5/16 In. LEDGER + MULTI-PLY SCREWS



- Code listed per DrJ TER No. 2102-01, 2102-02, and 2102-04 and State of Florida FL 41741
- Replaces nailing patterns that do not always draw the wood together and 1/2 in. lag screws in general construction projects
- Straight knurl reduces driving torque
- Nibs underhead help countersink screw
- Sharp point starts fast with no pre-drilling, reducing drive time
- Slashes for reduced splitting
- T-40 Star Drive provides more points of contact, reducing cam-outs and limiting bit wear
- CAMO PROTECH ULTRA 4 coating
- Interior and exterior use

NEW



SKU#	SIZE	QTY	DRIVER BIT	CT./MASTER	APPLICATION
0366180	2-7/8 in. (73mm) x 5/16 in. (7.9mm)	10	1 - T-40	8	Multi-Ply
0366184		50	1 - T-40	4	
0366189		250	2 - T-40	1	
0366190	3-1/2 in. (88.9mm) x 5/16 in. (7.9mm)	10	1 - T-40	8	Ledger + Multi-Ply
0366194		50	1 - T-40	4	
0366199		250	2 - T-40	1	
0366200	4 in. (101.6mm) x 5/16 in. (7.9mm)	10	1 - T-40	8	Ledger + Multi-Ply
0366204		50	1 - T-40	4	
0366209		250	2 - T-40	1	
0366210	4-1/2 in. (114.3mm) x 5/16 in. (7.9mm)	10	1 - T-40	8	Multi-Ply
0366214		50	1 - T-40	4	
0366219		250	2 - T-40	1	
0366220	5 in. (127mm) x 5/16 in. (7.9mm)	10	1 - T-40	8	Ledger + Multi-Ply
0366224		50	1 - T-40	4	
0366229		250	2 - T-40	1	
0366240	6 in. (152.4mm) x 5/16 in. (7.9mm)	10	1 - T-40	8	Multi-Ply
0366244		50	1 - T-40	2	
0366249		250	2 - T-40	1	
0366250	6-3/4 in. (171.5mm) x 5/16 in. (7.9mm)	10	1 - T-40	8	Multi-Ply
0366254		50	1 - T-40	2	
0366259		250	2 - T-40	1	

5/16 in. Flat Head Screws available in 8" and 10" lengths for Multi-Purpose applications - see p. 37

MULTI-PURPOSE FLAT HEAD SCREWS

NEW

- Code listed per DrJ TER No. 2102-01 and State of Florida FL 41741
- For deck posts, beams, and general construction projects
- Replaces traditional lag screws and through-bolts
- Straight knurl reduces driving torque
- Nibs underhead help countersink screw
- Sharp point starts fast with no pre-drilling, reducing drive time
- Slashes for reduced splitting
- Star Drive provides more points of contact, reducing cam-outs and limiting bit wear
- CAMO PROTECH ULTRA 4 coating
- For interior and exterior use



5/16 In. MULTI-PURPOSE FLAT HEAD SCREWS

SKU#	SIZE	QTY	DRIVER BIT	CT./MASTER
0366260	8 in. (203.2mm) x 5/16 in. (7.9mm)	10	1 - T-40	10
0366264		50	1 - T-40	2
0366269		250	2 - T-40	1
0366270	10 in. (254mm) x 5/16 in. (7.9mm)	10	1 - T-40	8
0366274		50	1 - T-40	2
0366279		250	2 - T-40	1



1/4 In. MULTI-PURPOSE FLAT HEAD SCREWS

SKU#	SIZE	QTY	DRIVER BIT	CT./MASTER
0360170	3 in. (76.2mm) x 1/4 in. (6.35mm)	10	1 - T-30	8
0360174		50	1 - T-30	4
0360179		500	2 - T-30	1
0360200	4 in. (101.6mm) x 1/4 in. (6.35mm)	10	1 - T-30	8
0360204		50	1 - T-30	4
0360209		250	2 - T-30	1
0360240	6 in. (152.4mm) x 1/4 in. (6.35mm)	10	1 - T-30	8
0360244		50	1 - T-30	2
0360249		250	2 - T-30	1
0360260	8 in. (203.2mm) x 1/4 in. (6.35mm)	10	1 - T-30	8
0360264		50	1 - T-30	2
0360269		250	2 - T-30	1
0360270	10 in. (254mm) x 1/4 in. (6.35mm)	10	1 - T-30	8
0360274		50	1 - T-30	2
0360279		250	2 - T-30	1

MULTI-PURPOSE HEX HEAD SCREWS

NEW

- Code listed per DrJ TER No. 2102-01 and State of Florida FL 41741
- For deck posts, beams, and general construction projects
- Slashes for reduced splitting
- Sharp point starts fast with no pre-drilling, reducing drive time
- Hex head with washer locks into a hex driver
- Straight knurl reduces driving torque
- Replaces lag screws
- Available in Hot-Dip Galvanized and CAMO PROTECH ULTRA 4 coating

PROTECH ULTRA 4 5/16 in. HEAVY DUTY MULTI-PURPOSE HEX HEAD SCREWS



SKU#	SIZE	QTY	DRIVER BIT	CT./MASTER
0365260	8 in. (203.2mm) x 5/16 in. (7.9mm)	10	7/16 in. Hex	8
0365264		50	7/16 in. Hex	2
0365269		250	7/16 in. Hex	1
0365270	10 in. (254mm) x 5/16 in. (7.9mm)	10	7/16 in. Hex	8
0365274		50	7/16 in. Hex	2
0365279		250	7/16 in. Hex	1
0365280	12 in. (304.8mm) x 5/16 in. (7.9mm)	10	7/16 in. Hex	6
0365284		50	7/16 in. Hex	2

PROTECH ULTRA 4 1/4 in. MULTI-PURPOSE HEX HEAD SCREWS



SKU#	SIZE	QTY	DRIVER BIT	CT./MASTER
0364090	1-½ in. (38.1mm) x 1/4 in. (6.35mm)	25	3/8 in. Hex	8
0364094		250	3/8 in. Hex	4
0364170	3 in. (76.2mm) x 1/4 in. (6.35mm)	10	3/8 in. Hex	8
0364174		50	3/8 in. Hex	4
0364179		500	3/8 in. Hex	1
0364200	4 in. (101.6mm) x 1/4 in. (6.35mm)	10	3/8 in. Hex	8
0364204		50	3/8 in. Hex	4
0364209		250	3/8 in. Hex	1
0364240	6 in. (152.4mm) x 1/4 in. (6.35mm)	10	3/8 in. Hex	8
0364244		50	3/8 in. Hex	2
0364249		250	3/8 in. Hex	1

NEW

HOT-DIP GALVANIZED

5/16 in. HEAVY DUTY MULTI-PURPOSE HEX HEAD SCREWS



SKU#	SIZE	QTY	DRIVER BIT	CT./MASTER
0369260	8 in. (203.2mm) x 5/16 in. (7.9mm)	10	7/16 in. Hex	8
0369264		50	7/16 in. Hex	2
0369269		250	7/16 in. Hex	1
0369270	10 in. (254mm) x 5/16 in. (7.9mm)	10	7/16 in. Hex	8
0369274		50	7/16 in. Hex	2
0369279		250	7/16 in. Hex	1

HOT-DIP GALVANIZED

1/4 in. MULTI-PURPOSE HEX HEAD SCREWS



SKU#	SIZE	QTY	DRIVER BIT	CT./MASTER
0368200	4 in. (101.6mm) x 1/4 in. (6.35mm)	10	3/8 in. Hex	8
0368204		50	3/8 in. Hex	4
0368209		250	3/8 in. Hex	1
0368240	6 in. (152.4mm) x 1/4 in. (6.35mm)	10	3/8 in. Hex	8
0368244		50	3/8 in. Hex	4
0368249		250	3/8 in. Hex	1

EXTERIOR ACCESSORIES

POWER BITS



T-15



T-20



T-25



T-30



T-40

- Power bits come in each pail of exterior screws for convenience on the jobsite
- 2 in. (50.8mm) long
- Premium Star Drive power bit allows for better connections



SKU#	DESCRIPTION	QTY	CT./MASTER
0333900	T-15 Star Drive Power Bit	3	10
0333910	T-20 Star Drive Power Bit	3	10
0333920	T-25 Star Drive Power Bit	3	10
0333990	T-30 Star Drive Power Bit	3	10
0333930	T-40 Star Drive Power Bit	3	10





STAINLESS STEEL FASTENERS

CAMO offers a comprehensive line of Stainless Steel screws and nails to help you build a better deck in corrosive environments. Our 305 Stainless Steel screws deliver an aesthetic finish and hold up in your connections, while 316 Marine Grade Stainless Steel fasteners offer ultimate protection against corrosion in coastal and agricultural environments.

305 STAINLESS STEEL

- Exterior structures outside of 3,000 ft. from a saltwater shoreline
- Installations of pressure treated, PVC, composite, and capped composite boards
- Any outdoor project that you want to protect against potential corrosion

CORROSION RESISTANCE METER

While our PROTECH coating offers good resistance against mild corrosion, 305 and 316 Stainless Steel are the best alloys to build with in corrosive areas.

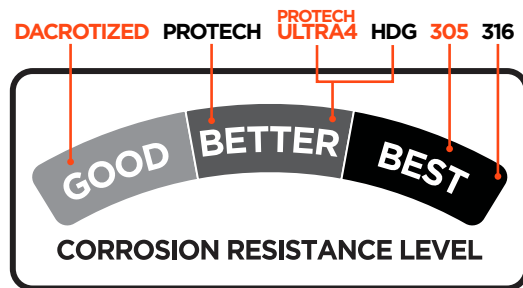

See p. 56 for more information

316 STAINLESS STEEL

- Coastal, marine, or waterway areas within 3,000 ft of saltwater
- Structures exposed to chlorine, wood strippers, or ice-melting chemicals
- Agricultural environments that deal with chemicals, pesticides, and treatments
- Installations of cedar, redwood, or hardwood decking where tannin release caused by carbon fasteners may cause staining

RECOMMENDED APPLICATIONS FOR EACH FASTENER:

DECK



- Wood decking projects
- Fences
- Any exterior wood-to-wood connection

COMPOSITE



- Composite decking projects
- PVC decking projects

EDGE



- Fasten any square deck board through the edge of the board using the MARKSMAN Pro tools

TRIM



- Decking
- Exterior trim
- Deck rails
- Balusters
- Fences

HAND DRIVE NAILS



- Decking
- Wood-to-wood connections
- Joist hangers

COLLATED NAILS



- Framing
- General construction
- Decks and fences
- Metal joist hangers

DECK SCREWS

- For fastening wood decking and other wood-to-wood connections in corrosive environments
- Type 17 slash point starts fast with no pre-drilling, reducing drive time
- Buglehead draws board tight, increasing pull-down strength
- 2/3 thread design offers premium holding power
- T-25 Star Drive provides more points of contact, reducing cam-outs and limiting bit wear
- Available in 305 Stainless Steel and 316 Stainless Steel

305 STAINLESS STEEL Deck Screws



SKU#	SIZE	QTY	DRIVER BIT	CT./MASTER	
0348100*	1-5/8 in. (41.3mm) x #8	100	30 sq. ft. (2.79m ²)	1 - T-25	12
0348104*		350	100 sq. ft. (9.29m ²)	1 - T-25	4
0348109*		1750	500 sq. ft. (46.45m ²)	2 - T-25	1
0348130*	2 in. (50.8mm) x #8	100	30 sq. ft. (2.79m ²)	1 - T-25	12
0348134*		350	100 sq. ft. (9.29m ²)	1 - T-25	4
0348139*		1750	500 sq. ft. (46.45m ²)	2 - T-25	1
0348150	2-1/2 in. (63.5mm) x #10	100	30 sq. ft. (2.79m ²)	1 - T-25	12
0348154		350	100 sq. ft. (9.29m ²)	1 - T-25	4
0348159		1750	500 sq. ft. (46.45m ²)	2 - T-25	1
0348170	3 in. (76.2mm) x #10	100	30 sq. ft. (2.79m ²)	1 - T-25	12
0348174		350	100 sq. ft. (9.29m ²)	1 - T-25	4
0348179		1750	500 sq. ft. (46.45m ²)	2 - T-25	1
0348190*	3-1/2 in. (88.9mm) x #10	50	30 sq. ft. (2.79m ²)	1 - T-25	12
0348194*		250	100 sq. ft. (9.29m ²)	1 - T-25	4
0348199*		1350	500 sq. ft. (46.45m ²)	2 - T-25	1
0348200*	4 in. (101.6mm) x #10	50	30 sq. ft. (2.79m ²)	1 - T-25	12
0348204*		250	100 sq. ft. (9.29m ²)	1 - T-25	4
0348209*		1350	500 sq. ft. (46.45m ²)	2 - T-25	1

316 STAINLESS STEEL MARINE GRADE
Deck Screws



SKU#	SIZE	QTY	COVERAGE	DRIVER BIT	CT./MASTER
0348100S	1-5/8 in. (41.3mm) x #9	100	30 sq. ft. (2.79m ²)	1 - T-25	12
0348104S		350	100 sq. ft. (9.29m ²)	1 - T-25	4
0348130S	2 in. (50.8mm) x #9	100	30 sq. ft. (2.79m ²)	1 - T-25	12
0348134S		350	100 sq. ft. (9.29m ²)	1 - T-25	4
0348139S		1750	500 sq. ft. (46.45m ²)	2 - T-25	1
0348150S	2-1/2 in. (63.5mm) x #10	100	30 sq. ft. (2.79m ²)	1 - T-25	12
0348154S		350	100 sq. ft. (9.29m ²)	1 - T-25	4
0348159S		1750	500 sq. ft. (46.45m ²)	2 - T-25	1
0348170S	3 in. (76.2mm) x #10	100	30 sq. ft. (2.79m ²)	1 - T-25	12
0348174S		350	100 sq. ft. (9.29m ²)	1 - T-25	4
0348179S		1750	500 sq. ft. (46.45m ²)	2 - T-25	1
0348190S	3-1/2 in. (88.9mm) x #10	50	30 sq. ft. (2.79m ²)	1 - T-25	12
0348194S		250	100 sq. ft. (9.29m ²)	1 - T-25	4
0348199S		1350	500 sq. ft. (46.45m ²)	2 - T-25	1

COMPOSITE SCREWS

- Color-matched screws for securing composite and PVC decking in highly corrosive environments
- Type 99 double slash point augers board material out for fast driving
- Trilobular shank reduces torque and prevents mushrooming
- Reverse thread at top increases pull-down power
- Cutting lead edge creates a flush finish
- T-20 Star Drive provides more points of contact, reducing cam-outs and limiting bit wear



COLOR MATCHER

Our Composite screws are available in painted finishes to match popular deck boards. Use the color matcher on camofasteners.com to find the right color for your board.

316 STAINLESS STEEL MARINE GRADE Composite Screws



SKU#	SIZE	QTY	COVERAGE	DRIVER BIT	CT./MASTER	COLOR	
0367158BS	2-½ in. (63.5mm) x #10	350	100 sq. ft. (9.29m ²)	1 - T-20	4	Brown	
0367159BS		1750	500 sq. ft. (46.45m ²)	2 - T-20	1		
0367158CS	2-½ in. (63.5mm) x #10	350	100 sq. ft. (9.29m ²)	1 - T-20	4	Cedar	
0367159CS		1750	500 sq. ft. (46.45m ²)	2 - T-20	1		
0367158ES	2-½ in. (63.5mm) x #10	350	100 sq. ft. (9.29m ²)	1 - T-20	4	Grey	
0367159ES		1750	500 sq. ft. (46.45m ²)	2 - T-20	1		
0367158DS	2-½ in. (63.5mm) x #10	350	100 sq. ft. (9.29m ²)	1 - T-20	4	Dark Brown	
0367159DS		1750	500 sq. ft. (46.45m ²)	2 - T-20	1		

SKU#	SIZE	QTY	COVERAGE	DRIVER BIT	CT./MASTER	COLOR	
0367158NS	2-½ in. (63.5mm) x #10	350	100 sq. ft. (9.29m ²)	1 - T-20	4	Stone Grey	
0367159NS		1750	500 sq. ft. (46.45m ²)	2 - T-20	1		
0367158RS	2-½ in. (63.5mm) x #10	350	100 sq. ft. (9.29m ²)	1 - T-20	4	Redwood	
0367159RS		1750	500 sq. ft. (46.45m ²)	2 - T-20	1		
0367158SS	2-½ in. (63.5mm) x #10	350	100 sq. ft. (9.29m ²)	1 - T-20	4	Sand	
0367159SS		1750	500 sq. ft. (46.45m ²)	2 - T-20	1		
0367158TS	2-½ in. (63.5mm) x #10	350	100 sq. ft. (9.29m ²)	1 - T-20	4	Tan	
0367159TS		1750	500 sq. ft. (46.45m ²)	2 - T-20	1		
0367158WS	2-½ in. (63.5mm) x #10	350	100 sq. ft. (9.29m ²)	1 - T-20	4	Winchester	
0367159WS		1750	500 sq. ft. (46.45m ²)	2 - T-20	1		
0367158GS	2-½ in. (63.5mm) x #10	350	100 sq. ft. (9.29m ²)	1 - T-20	4	Dark Grey	
0367159GS		1750	500 sq. ft. (46.45m ²)	2 - T-20	1		
0367158S	2-½ in. (63.5mm) x #10	350	100 sq. ft. (9.29m ²)	1 - T-20	4	Bright	
0367159S		1750	500 sq. ft. (46.45m ²)	2 - T-20	1		

305 STAINLESS STEEL

Bright Collated Face Screws for Composite

• For exclusive use with the CAMO **DRIVE**™ Tool

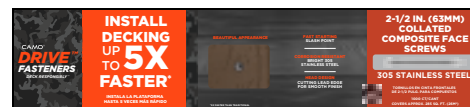

SKU#	SIZE	QTY	DRIVER BIT	CT./MASTER
0395080	2-½ in. (63.5mm) x #10	1000	2 - T-20	1

316 STAINLESS STEEL

Bright Collated Face Screws for Composite



SKU#	SIZE	QTY	DRIVER BIT	CT./MASTER
0367158S	2-½ in. (63.5mm) x #10	350	T-20	4
0367159S		1750	2-T-20	1

EDGE SCREWS

- Fastens all square deck boards: pressure treated, composite, PVC, capped composite, cedar, redwood, and hardwood
- Patented rake tip augers material out as they're driven, reducing the potential for splitting and cracking*

- Trimhead reduces visibility on the edge of the board
- T-15 Star Drive offers best connection, reducing cam-outs and stripped screws

*Pre-drilling is required for hardwoods and capped composites

316 STAINLESS STEEL MARINE GRADE Edge Screws

- For exclusive use with CAMO **MARKSMAN Pro** Tools



SKU#	SIZE	QTY	COVERAGE	DRIVER BIT	CT./MASTER
0345220S	1-7/8 in. (47.6mm) x #7	100	30 sq. ft. (2.79m ²)	--	12
0345228S		350	100 sq. ft. (9.29m ²)	1 - T-15	12
0345224S		700	200 sq. ft. (18.58m ²)	2 - T-15	4
0345219S		1750	500 sq. ft. (46.45m ²)	2 - T-15	1
0345240S	2-3/8 in. (60.3mm) x #7	100	30 sq. ft. (2.79m ²)	--	12
0345248S		350	100 sq. ft. (9.29m ²)	1 - T-15	12
0345244S		700	200 sq. ft. (18.58m ²)	2 - T-15	4
0345239S		1750	500 sq. ft. (46.45m ²)	2 - T-15	1

316 STAINLESS STEEL MARINE GRADE Collated Edge Screws

- For exclusive use with the CAMO **DRIVE** Tool



SKU#	SIZE	QTY	COVERAGE	DRIVER BIT	CT./MASTER
0395020S	2-3/8 in. (60.3mm) x #7	1000	285 sq. ft. (26.5m ²)	2 - T-15	1

TRIM SCREWS

- For fastening wood and PVC deck trim and finish applications in corrosive environments
- Type 17 slash point starts fast with no pre-drilling
- Trimhead screw reduces visibility in finish projects
- T-15 Star Drive provides more points of contact, reducing cam-outs and limiting bit wear
- Available in Bright 305 Stainless Steel, Bright 316 Stainless Steel, and Painted 316 Stainless Steel

305 STAINLESS STEEL

Trim Screws



SKU#	SIZE	QTY	DRIVER BIT	CT./MASTER
0350100*	1-5/8 in. (41.3mm) x #8	100	1 - T-15	12
0350104*		350	1 - T-15	4
0350130*	2 in. (50.8mm) x #8	100	1 - T-15	12
0350134*		350	1 - T-15	4
0350150*	2-1/2 in. (63.5mm) x #8	100	1 - T-15	12
0350154*		350	1 - T-15	4
0350170*	3 in. (76.2mm) x #8	100	1 - T-15	12
0350174*		350	1 - T-15	4

316 STAINLESS STEEL MARINE GRADE

Trim Screws



SKU#	SIZE	QTY	DRIVER BIT	CT./MASTER	HEAD
0350100S	1-5/8 in. (41.3mm) x #8	100	1 - T-15	12	
0350104S		350	1 - T-15	4	
0350130S	2 in. (50.8mm) x #8	100	1 - T-15	12	
0350134S		350	1 - T-15	4	
0350150S	2-1/2 in. (63.5mm) x #8	100	1 - T-15	12	
0350154S		350	1 - T-15	4	
0350170S	3 in. (76.2mm) x #8	100	1 - T-15	12	
0350174S		350	1 - T-15	4	
0350190S	3-1/2 in. (88.9mm) x #8	100	1 - T-15	12	
0350194S		350	1 - T-15	4	

STAINLESS STEEL - TRIM SCREWS

316 STAINLESS STEEL MARINE GRADE - PAINTED

Trim Screws



COLOR MATCHER

Our Stainless Steel Trim screws are available in painted finishes to match popular deck boards.

Use the color matcher on camofasteners.com to find the right color for your board.

SKU#	SIZE	QTY	DRIVER BIT	CT./MASTER	COLOR
0353000ES	1-5/8 in. (41.3mm) x #8	100	1 - T-15	12	Grey
0353004ES		350	1 - T-15	4	
0353009ES		1750	2 - T-15	1	
0353050ES	2-1/2 in. (63.5mm) x #8	100	1 - T-15	12	
0353054ES		350	1 - T-15	4	
0353059ES		1750	2 - T-15	1	
0353000RS	1-5/8 in. (41.3mm) x #8	100	1 - T-15	12	Redwood
0353004RS		350	1 - T-15	4	
0353009RS		1750	2 - T-15	1	
0353050RS	2-1/2 in. (63.5mm) x #8	100	1 - T-15	12	
0353054RS		350	1 - T-15	4	
0353059RS		1750	2 - T-15	1	
0353000WS	1-5/8 in. (41.3mm) x #8	100	1 - T-15	12	Winchester
0353004WS		350	1 - T-15	4	
0353009WS		1750	2 - T-15	1	
0353050WS	2-1/2 in. (63.5mm) x #8	100	1 - T-15	12	
0353054WS		350	1 - T-15	4	
0353059WS		1750	2 - T-15	1	
0353000NS	1-5/8 in. (41.3mm) x #8	100	1 - T-15	12	Stone Grey
0353004NS		350	1 - T-15	4	
0353009NS		1750	2 - T-15	1	
0353050NS	2-1/2 in. (63.5mm) x #8	100	1 - T-15	12	
0353054NS		350	1 - T-15	4	
0353059NS		1750	2 - T-15	1	
0353000GS	1-5/8 in. (41.3mm) x #8	100	1 - T-15	12	Dark Grey
0353004GS		350	1 - T-15	4	
0353009GS		1750	2 - T-15	1	
0353050GS	2-1/2 in. (63.5mm) x #8	100	1 - T-15	12	
0353054GS		350	1 - T-15	4	
0353059GS		1750	2 - T-15	1	

SKU#	SIZE	QTY	DRIVER BIT	CT./MASTER	COLOR	
0353000SS	1-5/8 in. (41.3mm) x #8	100	1 - T-15	12	Sand	
0353004SS		350	1 - T-15	4		
0353009SS		1750	2 - T-15	1		
0353050SS	2-1/2 in. (63.5mm) x #8	100	1 - T-15	12		
0353054SS		350	1 - T-15	4		
0353059SS		1750	2 - T-15	1		
0353000DS	1-5/8 in. (41.3mm) x #8	100	1 - T-15	12	Dark Brown	
0353004DS		350	1 - T-15	4		
0353009DS		1750	2 - T-15	1		
0353050DS	2-1/2 in. (63.5mm) x #8	100	1 - T-15	12		
0353054DS		350	1 - T-15	4		
0353059DS		1750	2 - T-15	1		
0353000CS	1-5/8 in. (41.3mm) x #8	100	1 - T-15	12	Cedar	
0353004CS		350	1 - T-15	4		
0353009CS		1750	2 - T-15	1		
0353050CS	2-1/2 in. (63.5mm) x #8	100	1 - T-15	12		
0353054CS		350	1 - T-15	4		
0353059CS		1750	2 - T-15	1		
0353100S	1-5/8 in. (41.3mm) x #8	100	1 - T-15	12	White	
0353104S		350	1 - T-15	4		
0353109S		1750	2 - T-15	1		
0353150S	2-1/2 in. (63.5mm) x #8	100	1 - T-15	12		
0353154S		350	1 - T-15	4		
0353159S		1750	2 - T-15	1		
0353000BS	1-5/8 in. (41.3mm) x #8	100	1 - T-15	12	Brown	
0353004BS		350	1 - T-15	4		
0353009BS		1750	2 - T-15	1		
0353050BS	2-1/2 in. (63.5mm) x #8	100	1 - T-15	12		
0353054BS		350	1 - T-15	4		
0353059BS		1750	2 - T-15	1		
0353000TS	1-5/8 in. (41.3mm) x #8	100	1 - T-15	12	Tan	
0353004TS		350	1 - T-15	4		
0353009TS		1750	2 - T-15	1		
0353050TS	2-1/2 in. (63.5mm) x #8	100	1 - T-15	12		
0353054TS		350	1 - T-15	4		
0353059TS		1750	2 - T-15	1		

POWER BITS



T-15



T-20



T-25

- Power bits come in each pail of exterior screws for convenience on the jobsite.
- 2 in. (50.8mm) long
- Premium Star Drive power bit allows for better connections



SKU#	DESCRIPTION	QTY	CT./MASTER
0333900	T-15 Star Drive Power Bit	3	10
0333910	T-20 Star Drive Power Bit	3	10
0333920	T-25 Star Drive Power Bit	3	10

HAND DRIVE NAILS

316 STAINLESS STEEL MARINE GRADE

Ring Shank Deck Nails



- For fastening wood patios and decks and other exterior wood-to-wood connections in corrosive environments
- Diamond point starts easily
- Ring shank offers superior holding power and withdrawal force
- Checkered flat head provides a large striking surface, reducing hammer slippage for easy drive connection



SKU#	SIZE	QTY	SHANK	CT./MASTER
5246158S*	2-½ in. (63.5mm) x #8	1 lb.	Ring	4
5246155S*		5 lb.	Ring	12
5246178S*	3 in. (76.2mm) x #10	1 lb.	Ring	12
5246175S*		5 lb.	Ring	4
5246179S*		25 lb.	Ring	4
5246188S*	3-¼ in. (82.5mm) x #12	1 lb.	Ring	12
5246185S*		5 lb.	Ring	4
5246195S*	3-½ in. (88.9mm) x #16	5 lb.	Ring	12
5246199S*		25 lb.	Ring	4

316 STAINLESS STEEL MARINE GRADE

Joist Hanger Nails



- For installing joist hangers to wood framing in corrosive environments
- Diamond point starts easily
- Smooth shank is fast and easy to drive
- Short, heavy gauge provides superior holding power
- Flat head provides a large striking surface for easy drive connection



SKU#	SIZE	QTY	SHANK	CT./MASTER
5096095S*	1-½ in. (38.1mm) x #9	5 lb.	Smooth	4

COLLATED NAILS

316 STAINLESS STEEL MARINE GRADE

Collated Ring Shank Framing Nails (21° Plastic Strip)

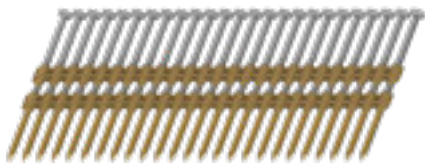

- For general construction, framing, deck, and fence building in corrosive environments
- Ring shank offers superior holding power and withdrawal force
- Round head provides greater resistance to pull out
- 21° plastic strip fits most 20°-22° framing nailers



SKU#	SIZE	QTY	SHANK
5710258S*	2- ⁵ / ₈ in. (60.3mm) x .113	1000	Ring
5710176S*	3 in. (76.2mm) x .120	1000	Ring
5710286S*	3- ¹ / ₄ in. (82.5mm) x .120	1000	Ring

316 STAINLESS STEEL MARINE GRADE

Collated Metal Hanger Nails (31° Paper Strip)



- For metal connectors, joist hangers, joist ties, and hurricane straps in corrosive environments
- Smooth shank provides good holding power
- Round head provides greater resistance to pull out
- Metal hanger nail strip fits most 31° metal connector nailers



SKU#	SIZE	QTY	SHANK
5606090S*	1- ¹ / ₂ in. (38.1mm) x .148	1000	Smooth



WHAT CAMO FASTENERS ARE MADE OF

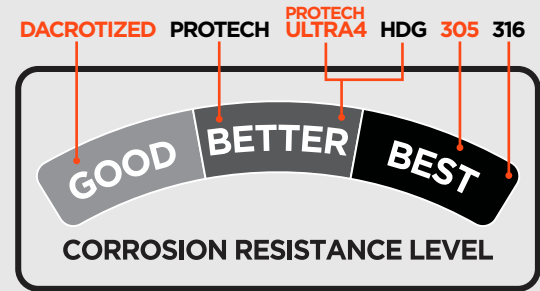

Building a deck, framing a house, or tackling any exterior project with CAMO fasteners means **building better**. CAMO fasteners start **fast**, create **strong connections**, and **hold up to the elements** over time, thanks to their coating and alloys.

Learn more about each option below so **you can be confident** you've got the right fastener for your project and gain **peace of mind** knowing that they are all **backed by a CAMO Warranty**.

PROTECH[™]



PROTECH is our proprietary coating for our steel screws. It is suitable for use with pressure treated lumber, PVC, composite, and capped composite deck boards in inland environments that face regular exposure to the elements. Our PROTECH-coated fasteners are guaranteed against rust and corrosion for the life of your project so long as they are installed following CAMO recommendations.

PROTECH-COATED FASTENERS ARE SUITABLE IN MANY APPLICATIONS:

- Decks, patios, and structures in inland areas away from water
- Installations of pressure treated, PVC, composite, and capped composite boards
- Exterior projects in temperate climates that face typical weather events

PROTECH[™] ULTRA 4



Our proprietary PROTECH Ultra 4 four-layer coating system provides optimum corrosion resistance, UV and environmental protection, and torque reduction for a high-performing, long-lasting screw. Tested in accordance with ASTM G198, the coating meets or exceeds the protection of code-approved hot-dip galvanized (ASTM A153, Class D) in ground contact general use pressure treated lumber (AWPA UC1-UC4A). We test our coating 2X longer than industry standard requires, so you can be confident your connections will stand the test of time.

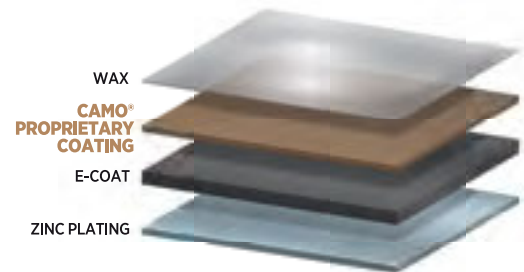

PROTECH ULTRA 4-COATED FASTENERS ARE SUITABLE IN MANY APPLICATIONS:

- For interior and exterior projects where corrosion resistance is key
- Structural projects that utilize a larger screw with a greater surface area, coming in contact with more wood
- Installations with ground contact general use pressure-treated lumber

HOT-DIP GALVANIZED



A small step under Stainless Steel in terms of corrosion protection, hot-dip galvanized coating is a viable and reliable option for various fasteners. The code-approved coating is tested to meet ASTM A153, Class D, and is approved for use in MCA ground contact pressure treated lumber.

The hot-dip galvanization process results in a thick coating that will wear over time but still offer excellent protection against corrosion for the lifetime of the exterior application. Additionally, the coating is applied uniformly, so your connections are completely protected.

HOT-DIP GALVANIZED COATING IS COMMONLY USED IN THE FOLLOWING APPLICATIONS:

- Exterior projects in temperate climates that you want to protect against the elements
- Structural projects that utilize larger screws with a greater surface area, coming in contact with more wood
- Coastal applications

305 STAINLESS STEEL



If your project is outside of 3,000 feet from a saltwater shoreline, Stainless Steel fasteners are recommended, and CAMO 305 Stainless Steel fits the bill. 305 Stainless Steel offers better resistance against corrosion than a carbon coating and will keep your project safe and long-lasting while offering excellent aesthetics. Widely available across the country, 305 Stainless Steel is a great alloy option for installing pressure treated lumber, PVC, composite, and capped composite deck boards no matter where you are located.

305 STAINLESS STEEL IS GREAT FOR A VARIETY OF APPLICATIONS:

- Exterior structures 3000 feet to 10 miles from a saltwater shoreline
- Installations of pressure treated, PVC, composite, and capped composite boards
- Any outdoor project that you want to protect against potential corrosion

316 STAINLESS STEEL







































































316 Stainless Steel is the best fastener for any project and is required for installations in highly corrosive areas, so your build remains structurally sound and aesthetically pleasing.

Saltwater environments present an opportunity for severe rust and corrosion, so 316 Stainless Steel is required in any coastal, marine, or waterway area within 3,000 feet of saltwater. We also recommend using 316 Stainless Steel in structures within a 10-mile reach of saltwater, which are susceptible to increased corrosion rates as saltwater is aerosolized.

316 STAINLESS STEEL IS RECOMMENDED IN A VARIETY OF APPLICATIONS BEYOND SALTWATER EXPOSURE:

- Structures near swimming pools where the surface will be exposed to chlorine
- Agricultural environments that deal with chemicals, pesticides, and treatments
- Decks, patios, and structures that will face wood strippers or ice-melting chemicals
- Installations of cedar, redwood, or hardwood decking where tannin release caused by carbon fasteners may cause staining and streaking

FIND THE RIGHT CAMO FASTENER BY STARTING WITH YOUR BOARDS	BOARD PROFILE	FASTENING METHOD	FASTENERS				
	 SQUARE  GROOVED	 EDGE  CLIP  FACE	 EDGE (Collated and Hand Drive)  COMPOSITE (Collated and Hand Drive)  DECK (Hand Drive)  FACE SCREW (Collated-For Pressure Treated)	 STARTER First Board  EDGE[®] 90° Patterns  EDGEX[®] Angled Patterns  EDGEXMETAL[®] Angled Patterns METAL JOISTS	 NEVER-MISS[™] Guide Included with CAMO Clips		
 Pressure Treated Lumber (Wet)	 SQUARE	 EDGE  CLIP  FACE	Collated Edge Screws • PROTECH [™] or 316 Stainless Steel Edge Screws • PROTECH [™] or 316 Stainless Steel Collated Face Screws for Pressure Treated • PROTECH [™] Deck Screws • PROTECH [™] , 305 Stainless Steel, 316 Stainless Steel				
		 EDGE  CLIP  FACE	Collated Edge Screws • PROTECH [™] or 316 Stainless Steel Edge Screws • PROTECH [™] or 316 Stainless Steel Collated Face Screws for Pressure Treated • PROTECH [™] Deck Screws • PROTECH [™] , 305 Stainless Steel, 316 Stainless Steel				
 Pressure Treated Lumber (KDAT)	 SQUARE	 EDGE  CLIP  FACE	Collated Edge Screws • PROTECH [™] or 316 Stainless Steel Edge Screws • PROTECH [™] or 316 Stainless Steel Collated Face Screws for Pressure Treated • PROTECH [™] Deck Screws • PROTECH [™] , 305 Stainless Steel, 316 Stainless Steel				
		 EDGE  CLIP  FACE	Collated Edge Screws • PROTECH [™] or 316 Stainless Steel Edge Screws • PROTECH [™] or 316 Stainless Steel Collated Face Screws for Pressure Treated • PROTECH [™] Deck Screws • PROTECH [™] , 305 Stainless Steel, 316 Stainless Steel				
 PVC & Composite (Uncapped)	 GROOVED	 EDGE  CLIP  FACE	STARTER Clips EDGE Clips EDGEX Clips EDGEXMETAL Clips	<input checked="" type="checkbox"/> <input checked="" type="checkbox"/> <input checked="" type="checkbox"/>			
		 EDGE  CLIP  FACE	Collated Edge Screws • PROTECH [™] or 316 Stainless Steel Edge Screws • PROTECH [™] or 316 Stainless Steel Collated Face Screws for Composite • PROTECH [™] or 305 Stainless Steel Composite Screws • PROTECH [™] or 316 Stainless Steel				
	 SQUARE	 EDGE  CLIP  FACE	Collated Edge Screws • PROTECH [™] or 316 Stainless Steel Edge Screws • PROTECH [™] or 316 Stainless Steel Collated Face Screws for Composite • PROTECH [™] or 305 Stainless Steel Composite Screws • PROTECH [™] or 316 Stainless Steel				
		 EDGE  CLIP  FACE	Collated Edge Screws • PROTECH [™] or 316 Stainless Steel Edge Screws • PROTECH [™] or 316 Stainless Steel Collated Face Screws for Composite • PROTECH [™] or 305 Stainless Steel Composite Screws • PROTECH [™] or 316 Stainless Steel				
 Composite (capped)	 GROOVED	 EDGE  CLIP  FACE	STARTER Clips EDGE Clips EDGEX Clips EDGEXMETAL Clips	<input checked="" type="checkbox"/> <input checked="" type="checkbox"/> <input checked="" type="checkbox"/>			
		 EDGE  CLIP  FACE	Edge Screws • PROTECH [™] or 316 Stainless Steel Collated Face Screws for Composite • PROTECH [™] or 305 Stainless Steel				
 Cedar & Redwood	 SQUARE	 EDGE  CLIP  FACE	Edge Screws • 316 Stainless Steel Collated Edge Screws • 316 Stainless Steel Deck Screws • 316 Stainless Steel				
		 EDGE  CLIP  FACE	Edge Screws • 316 Stainless Steel Collated Edge Screws • 316 Stainless Steel Deck Screws • 316 Stainless Steel				
 Hardwood	 GROOVED	 EDGE  CLIP  FACE	STARTER Clips EDGE Clips EDGEX Clips EDGEXMETAL Clips	<input checked="" type="checkbox"/> <input checked="" type="checkbox"/> <input checked="" type="checkbox"/>			
		 EDGE  CLIP  FACE	Edge Screws • 316 Stainless Steel				



TOOLS

CLIPDRIVE™	DRIVE™			MARKSMAN Pro®	MARKSMAN Pro® -X1	MARKSMAN Pro® -NB	MARKSMAN Edge™	LEVER®
	Edge	Clip	Face	Edge 3/16 in. Gap	Edge 1/16 in. Gap	Edge 3/16 in. Gap	Edge No Gap	Board Bending and Locking
	●				●		●	●
			●					●
								●
	●	■						●
			●	●		●		●
								●
			●					●
	●	■			●		●	●
			●					●
				●	■			●
								●
	●		●					●
	●		●					●
	●		●					●
				●	▼		●	●
			●	■				●
	●	■			●		●	●
	●	■						●
								●
	●		●					●
	●		●					●
	●		●					●
				●	▼		●	●

● USE THIS TOOL

■ USE SECONDARY 3/16 IN. SPACERS

▼ USE PRE-DRILL BIT

CAMO[®]

The Better Way to Build a Deck

MICHIGAN

2964 Clydon Ave SW
Grand Rapids, MI 49519

NEW YORK

5985 Tarbell Rd
Syracuse, NY 13206

GEORGIA

555 Riverside Pkwy, Ste. 100
Austell, GA 30168

TEXAS

3701 Yale St
Houston, TX 77018

CALIFORNIA

8939 Etiwanda Ave
Rancho Cucamonga, CA 91739

WASHINGTON

4512 70th Ave E Suite 400
Fife, WA 98424

FOR MORE INFORMATION, PLEASE VISIT WWW.CAMOFASTENERS.COM OR CALL
800-968-6245 TO SPEAK WITH A CAMO PRODUCT EXPERT.