



ONE-TOUCH[®] SILVER CHARCOAL GRILL

Read owner's guide before using the barbecue.

18½ inch
(47 cm)

22½ inch
(57 cm)



54240 US 07/20/13

EXPLODED VIEW

One-Touch® Silver 062411

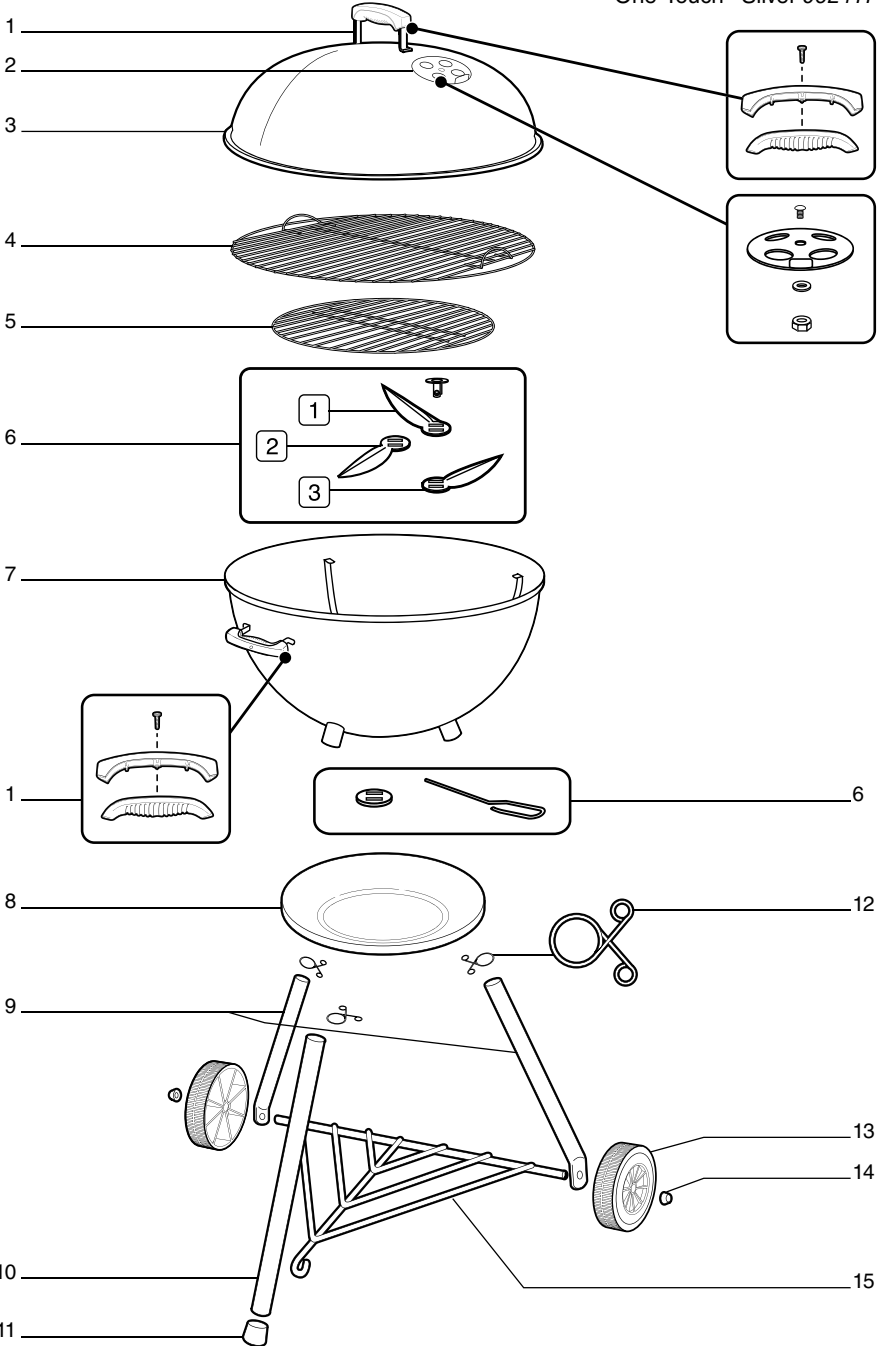

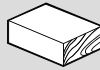

1-

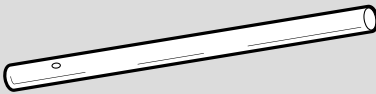
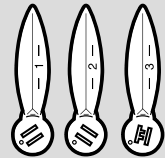
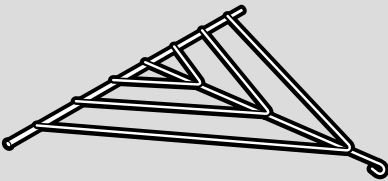
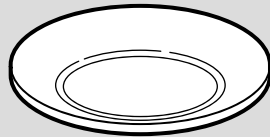
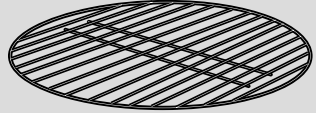
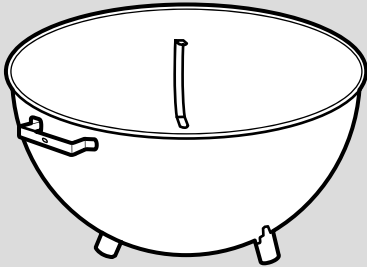
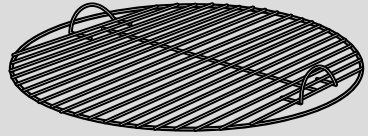
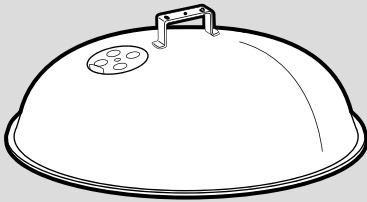

2-

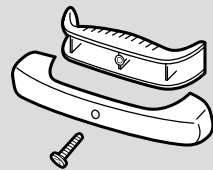

3-

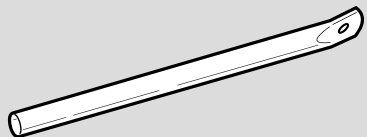
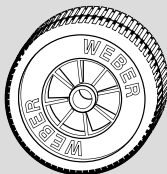

1

3- 

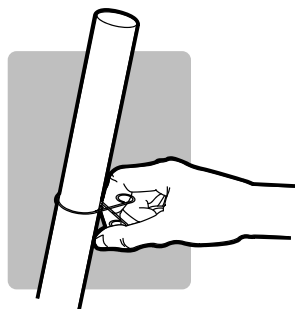
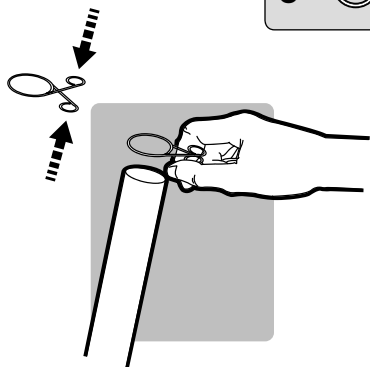
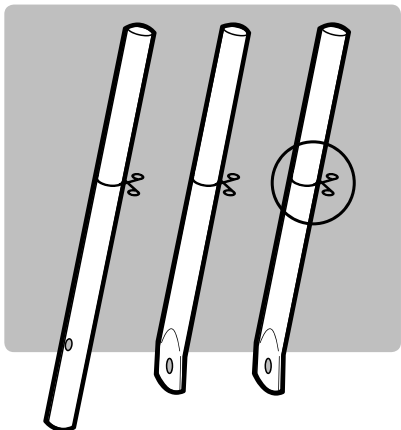

2

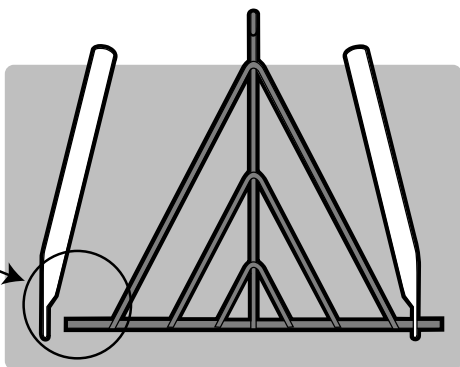
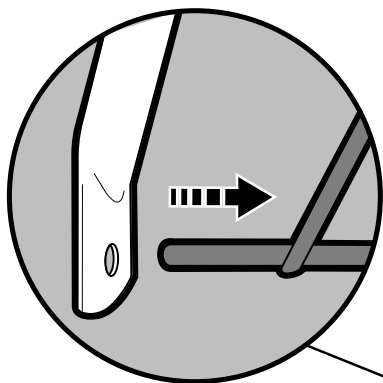

3

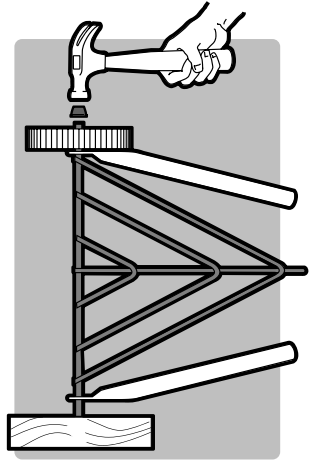
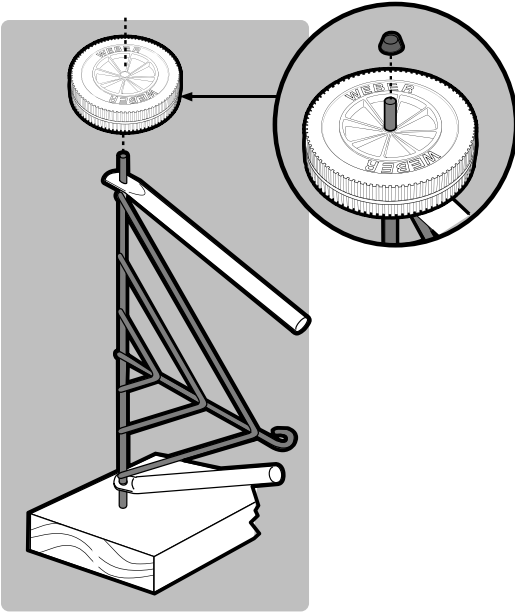
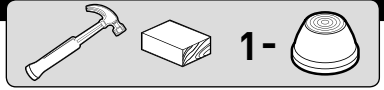

4

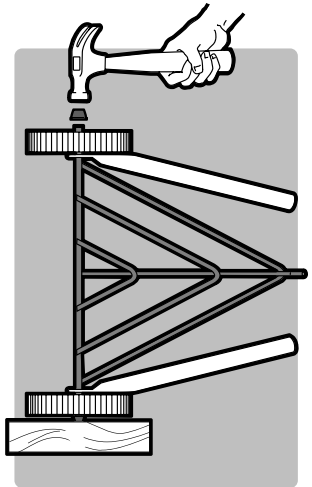
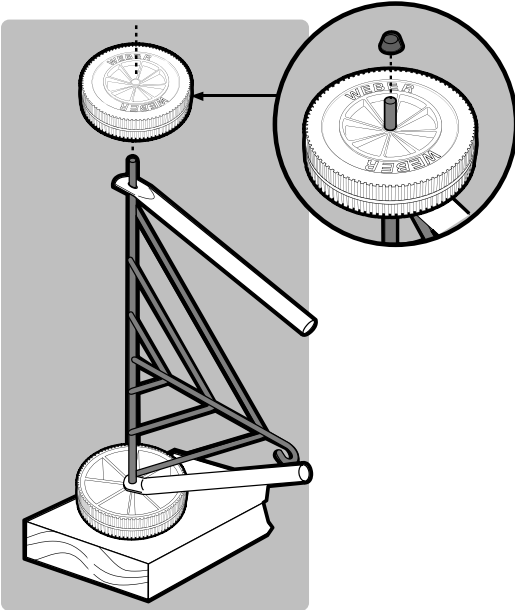
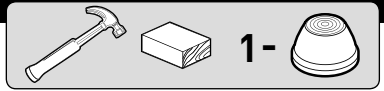

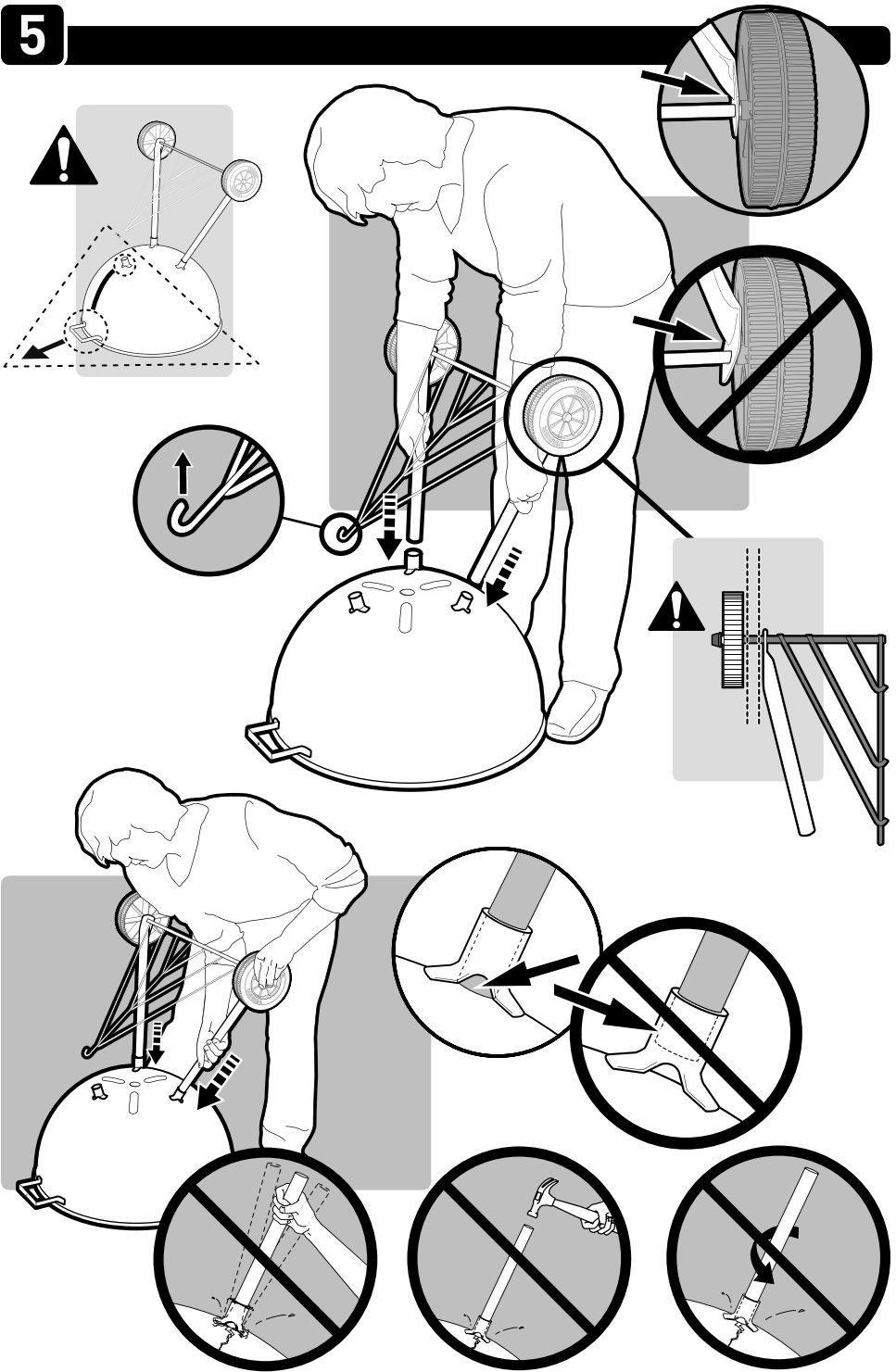

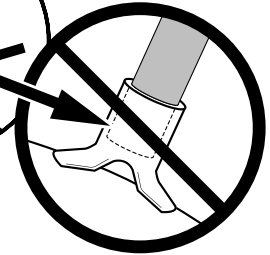
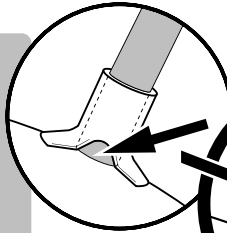
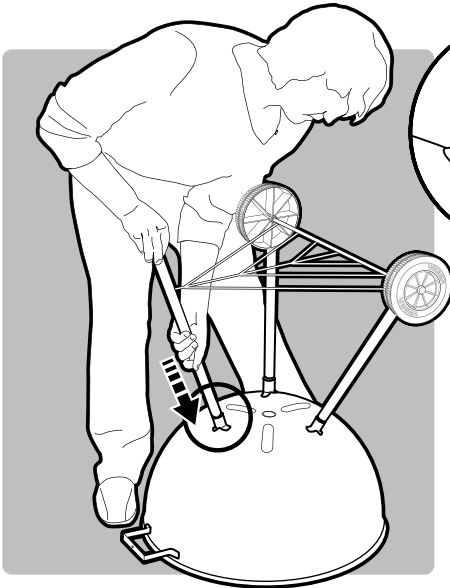
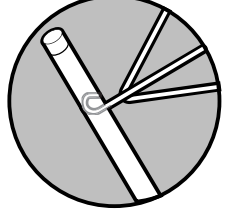
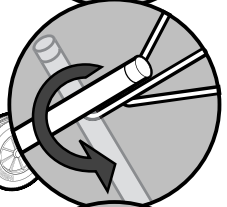
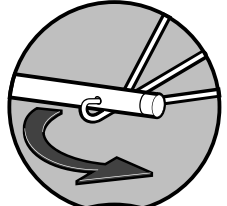
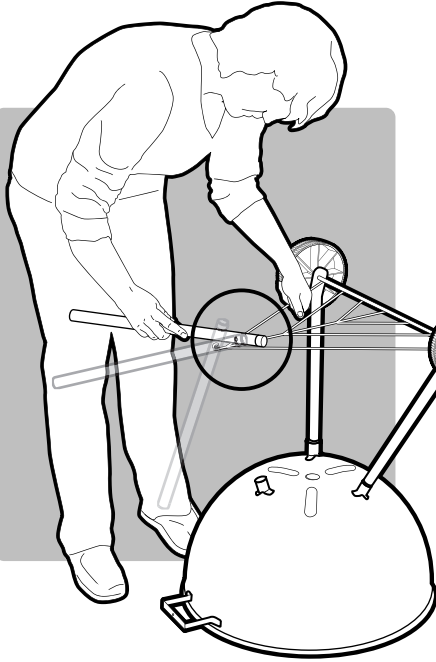
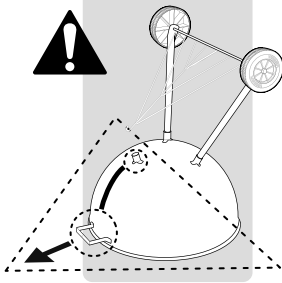
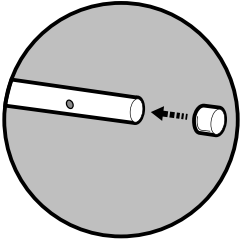

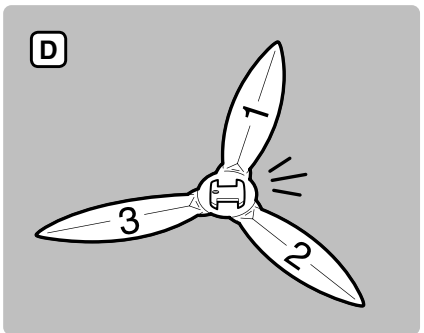
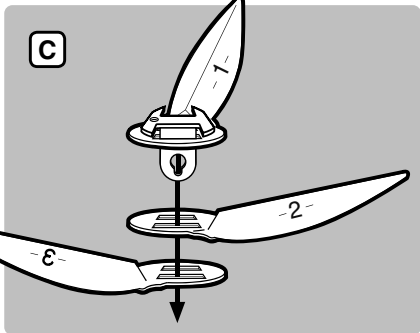
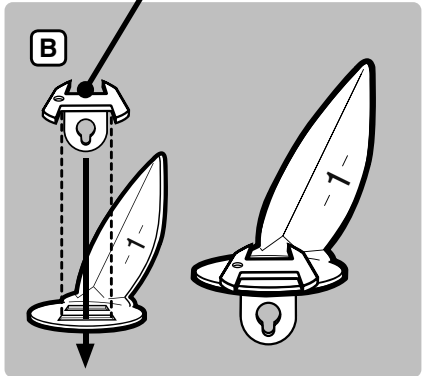
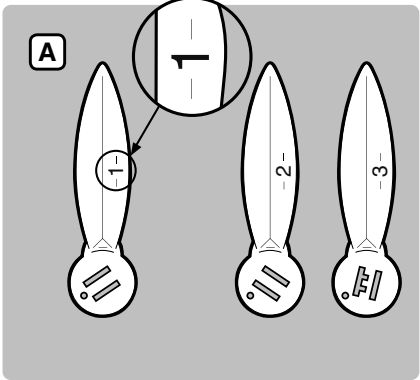
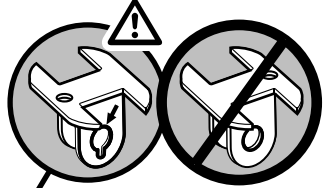
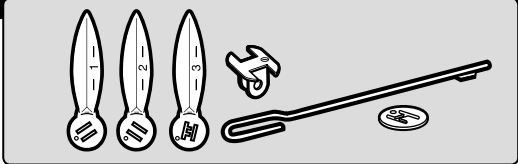

8

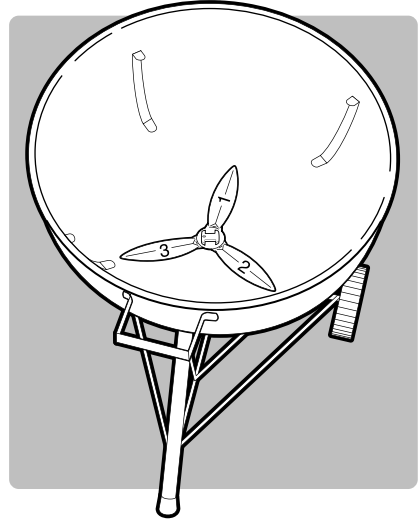
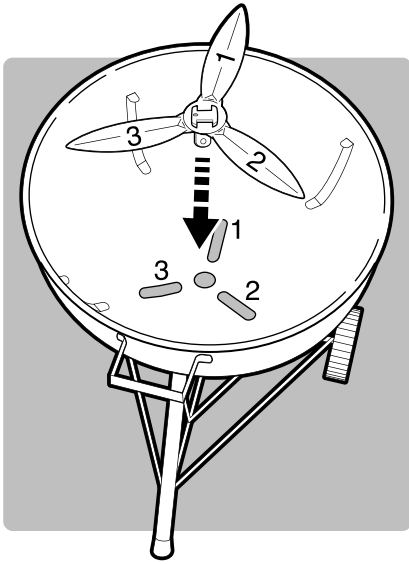

9

1- 

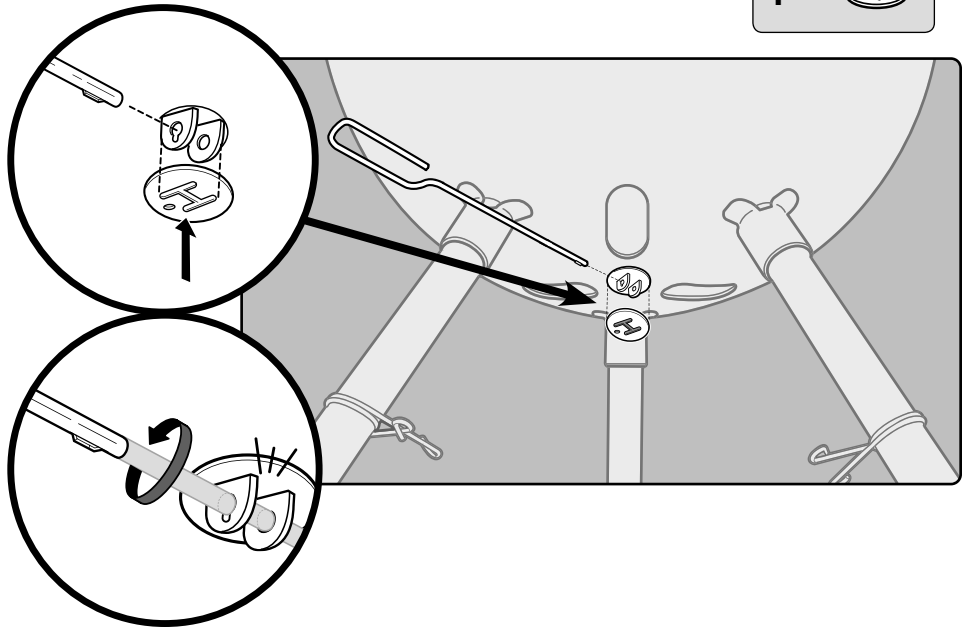

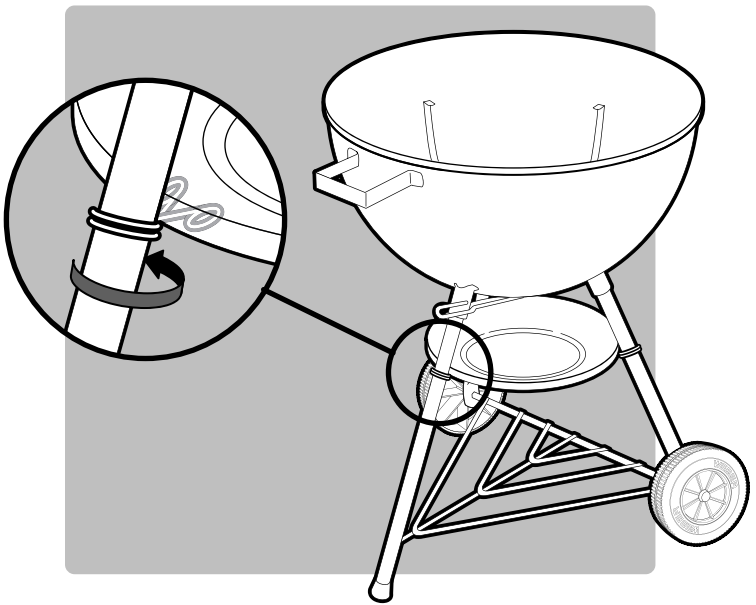
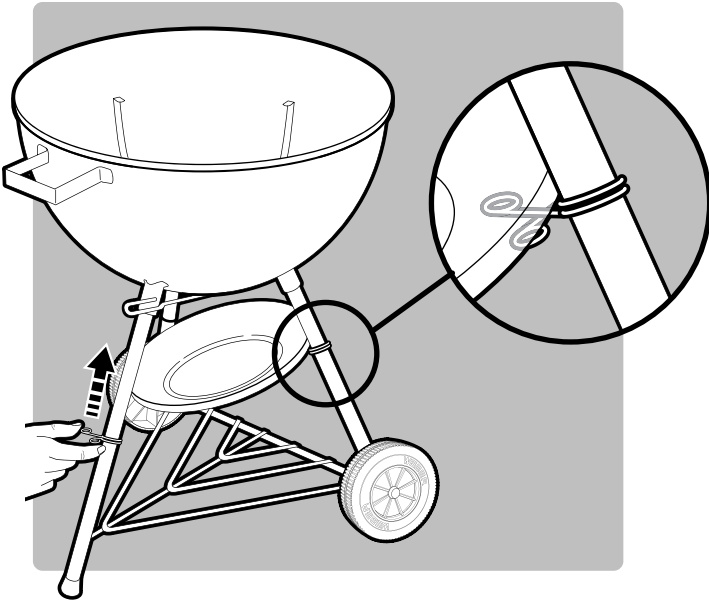

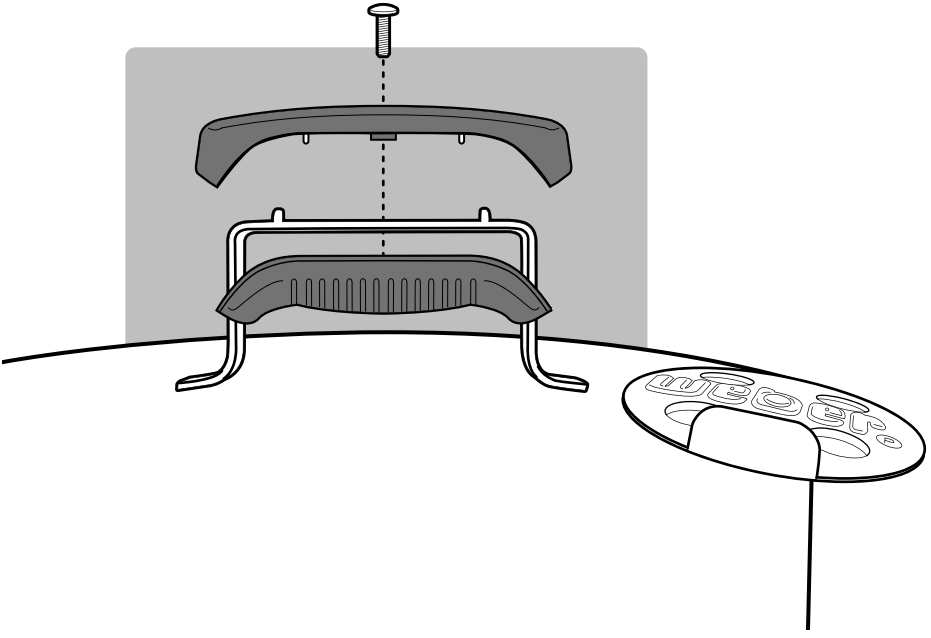
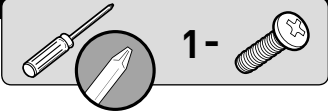

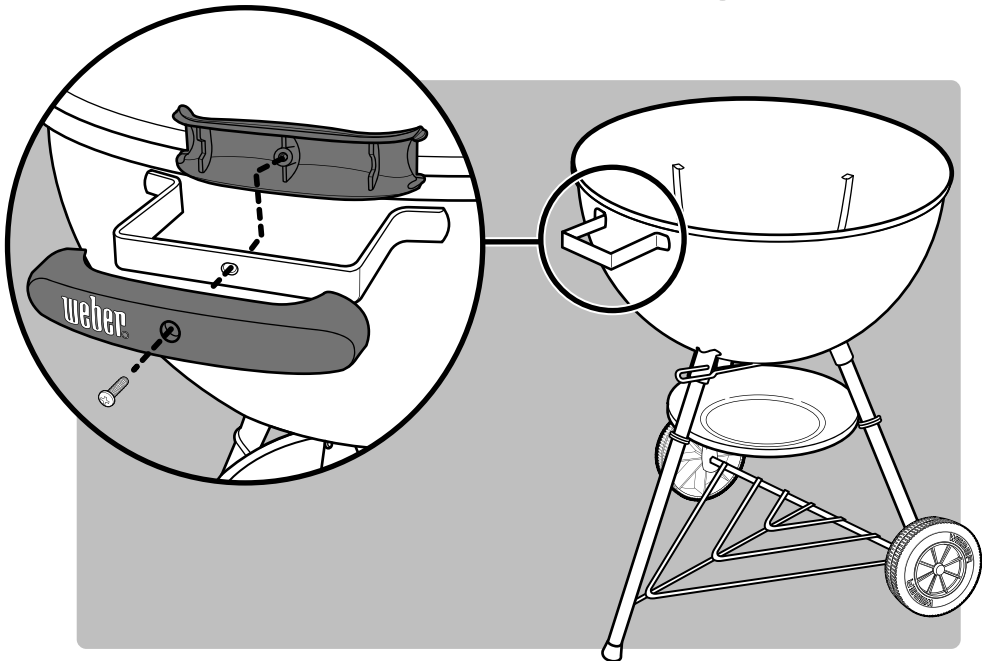
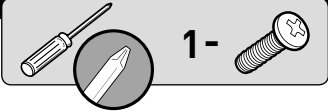

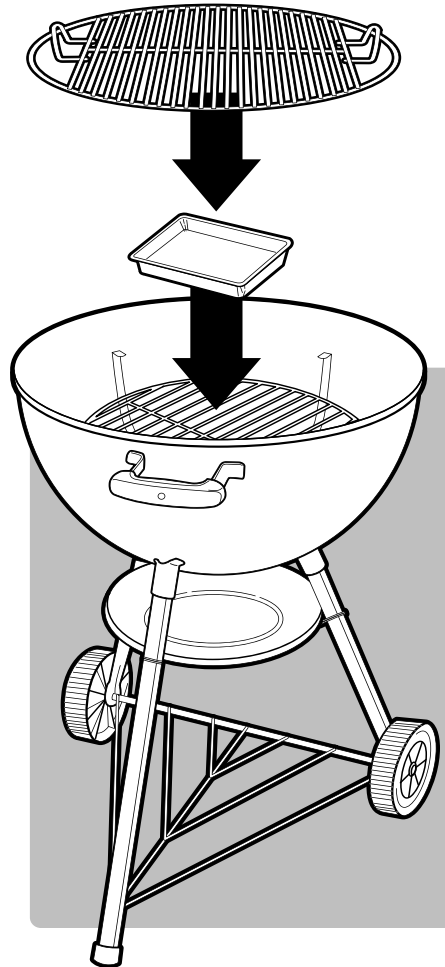
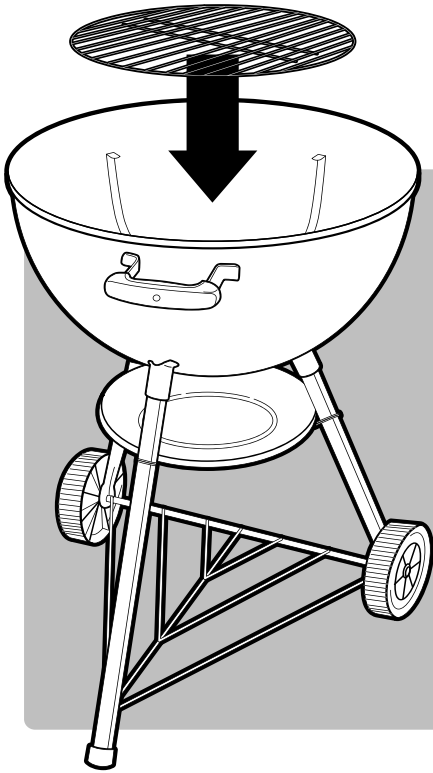

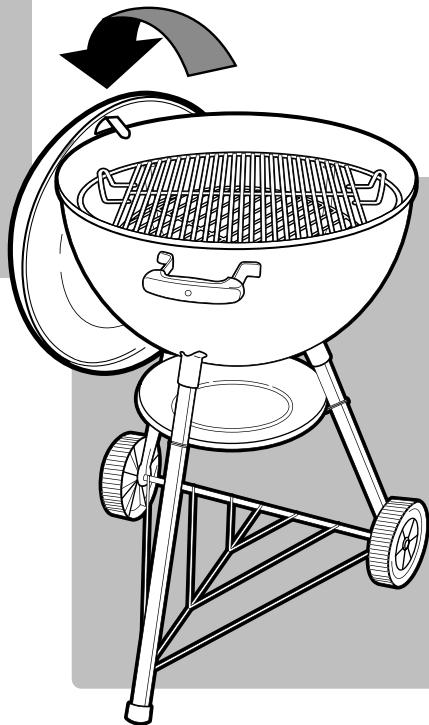
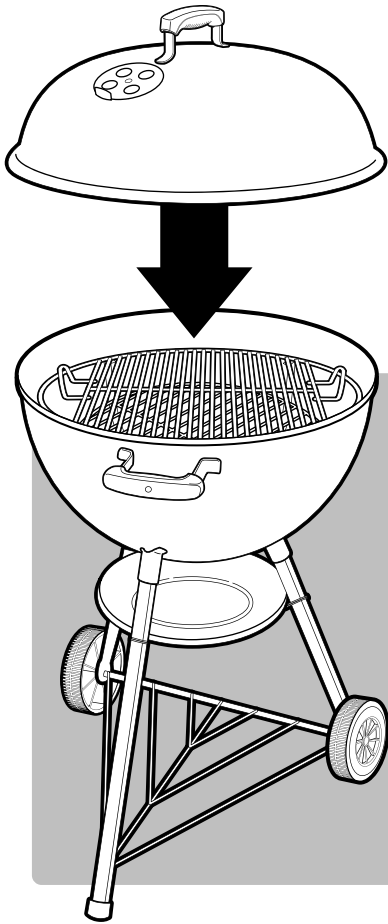

Lined writing area with 30 horizontal lines.



WEBER-STEPHEN PRODUCTS LLC
www.weber.com[®]

© 2013 Designed and engineered by Weber-Stephen Products LLC,
200 East Daniels Road, Palatine, Illinois 60067 U.S.A.
Printed in U.S.A.