



2021
PRODUCT
CATALOG



Ramset[®]
DRIVING JOBSITE SPEED

Table of Contents

Powder Training & Certification	2
Buy American Act	3
LEED Credits	4
Intro To Gas Technology	5
Fasteners – How They Work	6
Suggested Specifications	8
Troubleshooting	9
Tool Selection Guide	10
Powder Fastener & Load Selection Chart	12
Gas Fastening Systems	
TrakFast	14
T3MAG	15
T3SS	16
GypFast / G2	17
Ramset T4 I-F	18
Powder Fastening Systems	
RA27	20
XT540	21
Cobra	22
R25	22
Viper4	23
Accessories	
Pole Tools & Cups	24
Extension Poles	25
Tool Accessories	26
Gas Tool Fasteners	
TrakFast	28
T3MAG	29
GypFast / G2	29
T3SS	30
Powder Fasteners	32
Powder Loads	36
Performance/Submittal	38



ONLINE POWDER TRAINING AND CERTIFICATION

To protect the operator and assure safety on the jobsite, OSHA and ANSI require all powder actuated tool users to be trained and certified for the tool that will be used. Ramset enables you to receive training through our website training program. This approach combines interactive web-based training techniques and online testing with feedback during the test.

The course consists of approximately 30 pages of usage, safety, and troubleshooting material. Upon completion of this brief course, you will immediately take an online exam. With successful completion of the exam, you then print a Ramset certification card.

At the end of the course, you are also given the ability to download individual tool manuals.

To take the course, and be certified to operate a Ramset powder actuated tool:

- Go to www.Ramset.com
- Find the heading called *Get Your License*
- Click *P.A.T. Licensing*
- Click *Begin Operator Course* (choose English / Spanish / French)
- When course is complete, take the test
- After passing the test, download and print your certificate
- Place the certificate in your wallet



RAMSET TOOL SERVICE CENTERS

San Diego Tool Service Center

Lake Forest Tool Service Center

Atlanta Ramset Tool Service Center

Northeast and South

Ramset Tool Service
c/o Certified Tool Solutions
320 Northpoint Parkway SE
Suite Q
Acworth, GA 30102
Phone 770.218.6050
toolrepairs@gmail.com
www.ctstoolrepairs.com

West

Ramset Tool Service
c/o South Coast Tool Repair
9660 Chesapeake Drive
San Diego, CA 92123
Phone 858.569.0929
mfoerster@socorepair.com

Midwest

Ramset Tool Service
13825 West Business Center Drive
Unit A
Lake Forest, IL 60045
Phone 800.222.6990
toolrepair@itwserviceparts.com
www.ramsetrepair.com

Parts Only

Tool Parts Direct
888-358-0332
www.toolpartsdirect.com

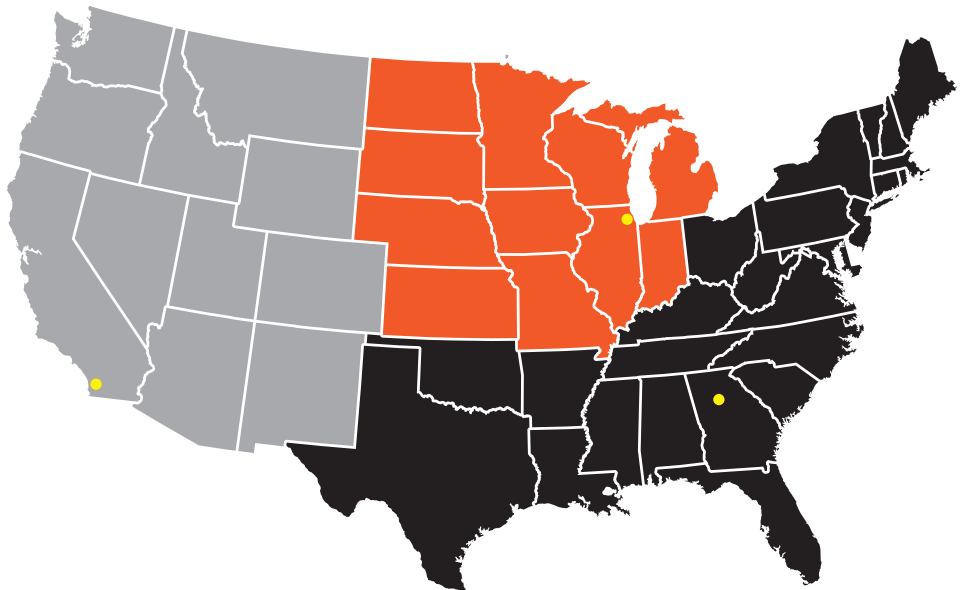

Ramset is unique in the world of construction tools and fasteners. Overall, 98% of Ramset fasteners and accessories are made in the USA.

Unlike our competitors you know you are buying American made products and supporting the American economy and workers when you buy Ramset. Ramset's parent company, Illinois Tool Works (NYSE: ITW) employees more than 25,000 Americans.



Manufacturer	Tools	Fasteners
Ramset Tools		
TrakFast	Libertyville, IL	Paris, KY
GypFast	Libertyville, IL	Paris, KY
T3SS	Libertyville, IL	Paris, KY
T3MAG	Libertyville, IL	Paris, KY
Ramset T4 I-F	Libertyville, IL	Toronto, Canada
Ramset Manufacturing		
Powder Loads Manufacturing		Oxford, MS
Gas Fuel Cells Production		Pontotoc, MS



The following is a sampling of projects that have utilized the Buy American Act using Ramset products:

- Rams / Chargers Stadium, Los Angeles CA
- Four Seasons, Boston MA
- Amazon Warehouse, San Antonio TX
- Midway Airport Expansion, Chicago IL
- Dolphins Stadium, Miami FL



What is LEED?

The purpose of Leadership in Energy and Environmental Design (LEED) is to construct buildings in an energy efficient manner and reduce the buildings' energy consumption. As a result, these buildings can help conserve non-renewable energy resources; decrease dependence on foreign oil; and lower greenhouse gas emissions.

Ramset LEED Credit MR 5.1

MR 5.1 was developed with the intent to increase demand for building materials and products that are extracted and manufactured within the region, thereby supporting the use of indigenous resources and reducing the environmental impact resulting from transportation.

Ramset fasteners may meet the requirements for LEED MR 5.1 if your project falls within 500 miles of our manufacturing facilities.

How to calculate LEED MR 5.1

LEED MR Credit 5.1 is calculated on a 500 mile radius from/to distribution points. Use Google Maps to calculate the distance to your project from:

Location	Zip Code	Product
Itasca, IL	60143	GypFast G2 & Fasteners
Paris, KY	40361	Powder & Gas Fasteners



Ramset Recycles

Ramset has always recognized the value of utilizing recycled materials where available.

The raw material sourced for the manufacture of Ramset pins contains approximately 10-20% mill scrap when it is converted to wire material. The plastic and casing material in our loads typically consists of 10% recycled material.

Our packaging also contains post-consumer recycled material. The paper board (inner cartons) containers are typically made from 40% recycled material; corrugated cartons typically contain 30-35% recycled material.

RECYCLING



ITW saw a challenge: how to create a portable tool that delivered the power of pneumatic tools without the hoses and compressors. In 1991, ITW Paslode conquered the challenge with the revolution of gas-powered technology. The cordless Impulse Finish Nailer delivered the power of pneumatic tools without cluttering job sites.

With the thought of Driving Jobsite Speed while creating a safer work environment, ITW Ramset built upon the Paslode technology and in 1992 introduced the TrakFast to the drywall trade. It forever changed the way

the world worked. In 2003, ITW Ramset followed up on the success of the TrakFast with the T3SS which is setting the standard for electrical and mechanical contractors.

Gas significantly lowers cost-in-place, reduces stress on the employee, and it's much quieter to use than drilling or powder actuated tools (PATs), so you can work in occupied buildings. There are times when you need the power and accuracy of our PATs—like the speed of our XT540 strip tool. But constant use of these tools can be noisy and overly jarring on the body.



Drywall



Electrical



Mechanical

- No Licensing Required
- Fast and Easy to Use
- Quiet—No Recoil
- No Cords or Hoses
- Long Fuel Cell & Battery Life

When the conditions are right, gas is the right choice.

Problem:
"My guys work on block all day long—from electrical boxes to furring. I've tried powder tools and they blow holes in block. What makes the Ramset technology different?"

Solution:
 Ramset technology has patented overdrive technology built in to every gas-powered tool. The tool works under the same principal as a combustion engine. A little gas, a little spark and a powerful shot, without the recoil associated with powder.

The industry transitions to gas technology

Problem:
"I don't want to have to re-license my guys to work with gas technology"

Solution:
 Since there are no loads, there's no licensing needed. In fact, Union Trainers have begun including the Ramset Gas Tools in training classes, and students can't believe how easy the tools are to work with.

In addition, the gas powered tools are totally portable and can be used for almost all your jobs—without the worry of having unspent loads on your jobsite.

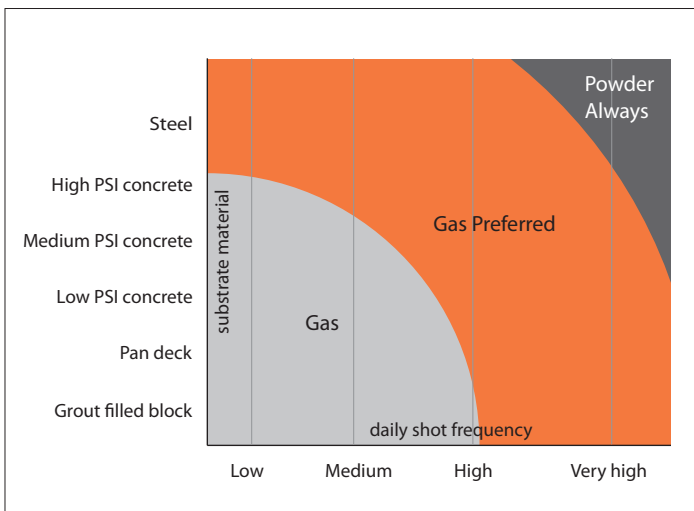

The Inside Story

The patented Ramset technology delivers precisely balanced power eliminating the damage caused by overdrive in PATs.

How it works: As the nosepiece is depressed, a rechargeable battery turns on the fan motor. In less than a second: a precise amount of fuel is injected into the combustion chamber. When the trigger is pulled, a spark creates an explosion that drives the piston into the fastener, and the fastener in the work surface. The action creates a vacuum that pulls the piston back to the start position.

In fact the technology is so precise it won't blow through a pop can.

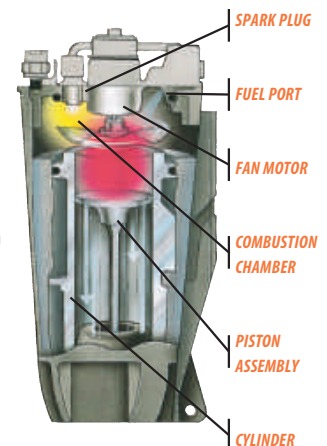

SELECTING THE CORRECT FASTENER LENGTH

SELECTING THE CORRECT FASTENER LENGTH

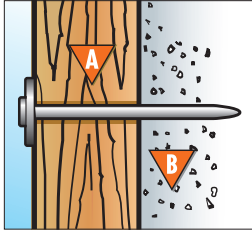

High quality fasteners provide consistent and reliable performance in concrete, block, masonry, and steel applications. Choosing the correct fastener for the job will assure professional results.

- A** Determine thickness of material being attached.
- B** Fastener must be long enough to drive approximately 1" into concrete, cement block or penetrate thickness of steel.

POWER LEVEL GUIDE FOR LOADS

All loads are color coded and load level numbered. As the number increases, the power level increases.

Always start with the lightest load. If the fastener does not set completely, use the next higher load and repeat the process.

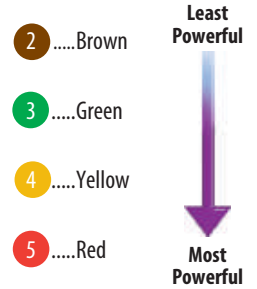

TYPICAL USES

	WOOD ATTACHMENT MATERIAL*	CONCRETE BASE MATERIAL		STRUCTURAL STEEL BASE	
		Commonly Used Fastener	Commonly Used Load	Commonly Used Fastener	Commonly Used Load
	2 x 4	1516SDC (2-1/2")	Yellow #4	1514SD (2") SP178 (1-7/8")	Red #5 Red #5
	3/4" Plywood for furring strip	1512 (1-1/2")	Yellow #4	1510 (1-1/4")	Yellow #4
	1/4" - 1/2"	1510 (1-1/4")	Green #3	SP34 (3/4")	Yellow #4

* Use Ramguard Pin for treated lumber.

	THIN GAGE STEEL	CONCRETE BASE MATERIAL		STRUCTURAL STEEL BASE	
		Commonly Used Fastener	Commonly Used Load	Commonly Used Fastener	Commonly Used Load
	Electrical Junction Boxes	M100BB (1")	Green #3	SP58TH (5/8")	Yellow #4
	Shelf Brackets	M100BB (1")	Green #3	SP34 (3/4")	Yellow #4
	Interior Drywall Track	1506/1506B (3/4")	Green #3	SP12 (1/2")	Yellow #4
	Perimeter Track	1510 (1-1/4")	Yellow #4	SP12 (1/2")	Yellow #4

NOTE: This chart is presented as a guide only. Start with the lightest load. If the fastener does not set completely, use the next higher load and repeat the process. Product suggestions may not be suitable for all types of base materials. Contact Technical Services if you have further questions.

FASTENING TO CONCRETE AND STEEL

FASTENING TO CONCRETE

As the fastener enters the concrete, extreme pressures and heat are created. This creates a bond that provides high loading strength in concrete snugly and provides tool protection.

FASTENING TO STEEL

The resilience of steel provides a clamping effect to the fastener. This combined with the tremendous heat that is created, provides a welding and clamping effect to give maximum holding power.

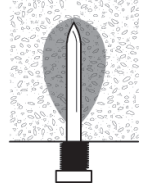

EDGE / SPACING / BASE MATERIAL THICKNESS REQUIREMENTS

The following represents the minimum edge and spacing requirements, plus base material thickness requirements:

CONCRETE

- 1. Edge distance.** Do not fasten closer than 3 inches from the edge of concrete. If the concrete cracks, the fastener may not hold and may allow the fastener to ricochet, causing serious injury or death to the operator or bystanders.
- 2. Recommended minimum fastener spacing.** Setting fasteners too close together can cause the concrete to crack. The recommended MINIMUM DISTANCE between fastening is three (3) inches. Never attempt a fastener application too close to another previously inserted fastener to prevent the second fastener from ricocheting off the previously installed fastener. A ricochet can result in serious injury or death to the operator or bystanders.
- 3. Concrete thickness.** It is important that the concrete be at least three (3) times as thick as the fastener penetration. If the concrete is too thin, the compressive forces forming at the fastener's point can cause the free face of the concrete to break away. This creates a dangerous condition from flying concrete and/or the fastener and also results in a reduction of fastener holding power.

STEEL

- 1. Edge distance.** The recommended edge distance for a fastener to the edge of steel is 1/2 inch. Never fire the tool within 1/2 inch of the edge of a steel base material because the steel may bend or break off, allowing the fastener to ricochet, causing serious injury or death to the operator or bystanders.
- 2. Recommended minimum fastener spacing.** The recommended minimum distance between fastening is 1 inch. Never attempt a fastening application too close to another previously inserted fastener to prevent the second fastener from ricocheting off the previously installed fastener. A ricochet can result in serious injury or death to the operator or bystanders.
- 3. Steel thickness.** Do not fasten into steel base material thinner than the fastener shank diameter. Holding power will be reduced and the fastener may be over-driven, creating a dangerous situation to the operator or bystanders due to a free-flying fastener.

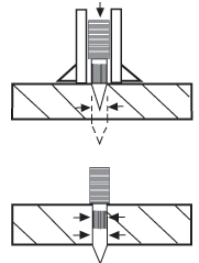

HOW TO SELECT A POWDER ACTUATED FASTENER

- **DRIVE PINS** are used to directly fasten an object (permanent installation).
- **THREADED STUDS** are used where the object fastened is to be removed or where shimming is required. The following shows how to determine shank and thread length. Required penetration is determined by load requirement (illustrated in the following examples).

Ramset fasteners may be specified by their type or catalog number to satisfy fastening requirements.

Permanent Installation

To Concrete

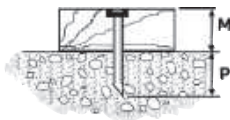

To Steel



Minimum Shank Length = Thickness of Material (M) + Thickness of Steel (T) + 1/4 Min. Point Allowance

Removable Installation

To Concrete

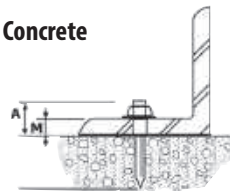

Thread Length (A) = Thickness of Material (M) + Allowance* for Nut & Washer

Shank Length = 1"

*Allowance for thickness of nut & washer = thread size (i.e. allow 1/4" for 1/4-20 thread, etc.)

To Steel

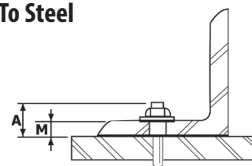

Thread Length (A) = Thickness of Material (M) + Allowance* for Nut & Washer

Shank Length = 1/2"

Ramset provides the architect and engineer the following suggested language and helpful information for the purpose of fastening specifications.

Plywood to Metal Framing or Truss

Part Number PLY138

Fasteners used shall have a 0.100 nominal shank diameter with helical knurl and a length of 1-3/8".



Track or Clip to Steel Beam

Part Number SP58TH

Fasteners used shall have a 0.300 head with a 0.150 knurled shank diameter and a length of 5/8".

Part Number TE12

Fasteners used shall have a 0.320 head with a 0.157 knurled shank diameter and a length of .545".



Exterior Sheathing to Metal Stud

Part Number GF112

Fasteners designated "GYPFAS" and have a helical knurled shank with a 1-1/2".



Interior Partition Track to Concrete

Part Number T3034B

Fasteners shall be designated T3 Type with a 0.125 nominal shank diameter and a length of 3/4".



Part Number TE100

Fasteners shall be designated "True Embedment" type with a 0.320 head with a 0.157 shank and length of 1.0625 providing minimum of 1" of embedment in up to 14ga track. Fastener shall have the embedment depth of 1" stamped on head.



Exterior Perimeter Track to Concrete

Part Number 1510SD

Fasteners used shall have a 0.145 nominal shank diameter and a length of 1-1/4". The fastener shall have a pre-assembled 7/8-inch washer.

Part Number TE114

Fasteners used shall be designated with a 0.157 dia. stepped shank to provide you with True Embedment depths of 1-1/4" in track up to 14 gauge.



For assistance with specifications and/or substitutions, contact Technical Service at 800-848-5611.

CONCRETE SYMPTOM

FASTENER DOES NOT HOLD IN BASE MATERIAL OR BASE MATERIAL SPALLS

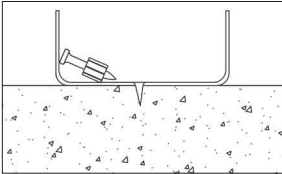

CAUSE

- High strength concrete
- Hard or large aggregate in concrete

ACTION

- Use shorter fastener
- Use PowerPoint pin
- Use load with a different power level

FASTENER PENETRATES TOO DEEP

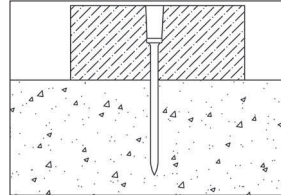

CAUSE

- Fastener too short for application
- Tool power level too high

ACTION

- Use longer fastener
- Use a lighter powder load

FASTENER DOES NOT PENETRATE DEEP ENOUGH

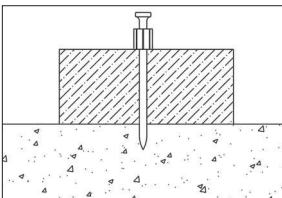

CAUSE

- Fastener too long
- Tool power level too low

ACTION

- Use shorter fastener
- Use a stronger powder load

FASTENER BENDS

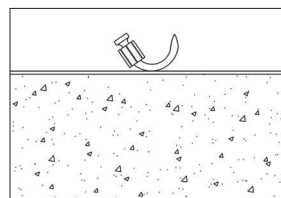

CAUSE

- Fastener hit large aggregate on entry
- Concrete too hard
- Fastener hit rebar just under the surface

ACTION

- Use shorter fastener
- Use PowerPoint pin
- Make sure tool is perpendicular to the work surface
- Move over 3 inches, try to fasten again

STEEL SYMPTOM

FASTENER DOES NOT PENETRATE THE SURFACE

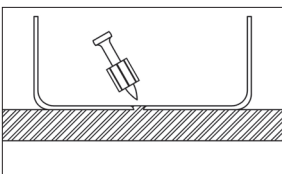

CAUSE

- Driving power too low
- Material may be too hard for forced entry fastener

ACTION

- Increase powder load level
- Use PowerPoint pin

FASTENER DOES NOT HOLD IN BASE MATERIAL

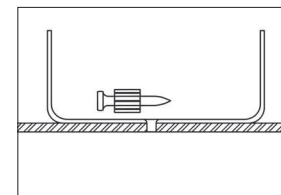

CAUSE

- Steel base material too thin

ACTION

- Use gas system tools with smaller Shank pin or Tek pin

FASTENER BREAKS OR BENDS

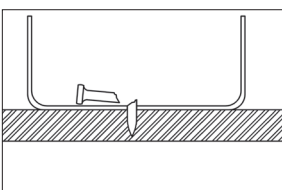

CAUSE

- Driving power is too low
- Fastener is too long
- Material may be too hard for forced entry fastener

ACTION

- Increase powder load level
- Reduce fastener length

FASTENER DOES NOT FULLY PENETRATE STEEL

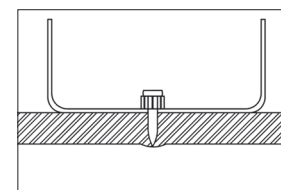

CAUSE

- Driving power too low
- Steel base material too thick
- Application limit may have been reached

ACTION

- Increase powder load level
- Use PowerPoint pin

GAS POWERED TOOLS

TOOL

DESCRIPTION

TYPICAL BUILDING TRADE*



TRAKFAST TF1200

- 42 Pin Magazine
- Fully Automatic
- 2 Year Warranty

- Length: 17.5"
- Height: 15-1/2"
- Weight: 7.9 lbs.
- Maximum Pin Length: 1-1/2"

METAL FRAMING



T3MAG

- 45-Pin Magazine
- One Step Fuel Injection & Eject
- Fully Automatic
- 2 Year Warranty

- Length: 18-1/2"
- Height: 15"
- Weight: 9.2 lbs.
- Maximum Pin Length: 1"

METAL FRAMING



T3SS

- Single Shot Gas Tool
- One Step Fuel Injection & Eject
- 2 Year Warranty

- Length: 13-1/2"
- Height: 15"
- Weight: 7.0 lbs.
- Maximum Pin Length: 1-1/2"

ELECTRICAL/MECHANICAL



GYPFAST G2

- 150 Pin Coil
- Fully Automatic
- 2 Year Warranty

- Length: 15"
- Height: 15.25"
- Weight: 7.6 lbs. (with battery)
- Maximum Pin Length: 2-1/2"

EXTERIOR SHEATHING



T4 I-F

- Single Shot Gas Tool
- One Step Fuel Injection & Eject
- 2 Year Warranty

- Length: 15"
- Height: 15.25"
- Weight: 7.6 lbs. (with battery)
- Maximum Pin Length: 6"

INSULATION

*Building trade shown as suggestions. Tools are not limited to these trades.

	TOOL	DESCRIPTION	TYPICAL BUILDING TRADE*
.27 CAL STRIP TOOLS	 <p>RA27</p> <ul style="list-style-type: none"> • Semi-Automatic • Power Adjust • 3 Year Warranty 	<ul style="list-style-type: none"> • Length: 15-3/4" • Weight: 5.3 lbs. • Muzzle Bushing O.D.: 3/4" • Maximum Pin Length: 1-1/2" (2" w/Washer) 	METAL FRAMING
	 <p>XT540</p> <ul style="list-style-type: none"> • Automatic Piston Return • Power Adjust • 3 Year Warranty 	<ul style="list-style-type: none"> • Length: 19" • Weight: 7.25 lbs. • Muzzle Bushing O.D.: 7/8" • Maximum Pin Length: 3" 	METAL FRAMING
	 <p>COBRA</p> <ul style="list-style-type: none"> • Semi-Automatic • Economical • 1 Year Warranty 	<ul style="list-style-type: none"> • Length: 13-1/4" • Weight: 5.0 lbs. • Muzzle Bushing O.D.: 9/16" • Maximum Pin Length: 2-1/2" (3" w/Washer) 	WOOD FRAMING
	 <p>VIPER4</p> <ul style="list-style-type: none"> • Automatic Piston Return • Designed Specifically for Overhead Applications • 3 Year Warranty 	<ul style="list-style-type: none"> • Length: 17" • Weight: 4.5 lbs. • Maximum Pin Length: 1-1/2" 	ACOUSTICAL/OVERHEAD
.25 CAL STRIP	 <p>R25</p> <ul style="list-style-type: none"> • Semi-Automatic • 1 Year Warranty 	<ul style="list-style-type: none"> • Length: 11.6" • Weight: 4.3 lbs. • Muzzle Bushing O.D.: 3/4" • Maximum Pin Length: 1-1/2" 	WALLS & CEILINGS

*Building trade shown as suggestions. Tools are not limited to these trades.

TO THIS BASE MATERIAL

FASTEN THIS MATERIAL

	CONCRETE				STEEL BEAM - 3/16" to 1/2" THICK			
	FASTENER LENGTH (inches)	GAS TOOL	POWDER TOOL	POWDER LOAD	FASTENER LENGTH (inches)	GAS TOOL	POWDER TOOL	POWDER LOAD
INTERIOR NON-LOAD BEARING DRYWALL TRACK 25 - 20 GAGE	3/4	TF1200 T3MAG	R25	#3 GRN .25cal STRIP	1/2	TF1200 T3MAG	R25	#4 YEL .25cal STRIP
			SA270	#3 GRN .27cal STRIP			RA27	#4 YEL .27cal STRIP
EXTERIOR PERIMETER DRYWALL TRACK 18 - 12 GAGE	1-1/4	N.R.	RA27	#4 YEL .27cal STRIP	1/2	N.R.	RA27	#4 YEL .27cal STRIP
			XT540	#4 YEL .27cal STRIP			XT540	#4 YEL .27cal STRIP
			COBRA	#4 YEL .27cal STRIP			COBRA	#4 YEL .27cal STRIP
CLIPS or BRACKETS for STEEL FRAMING	1-1/4	N.R.	RA27	#4 YEL .27cal STRIP	1/2	N.R.	RA27	#4 YEL .27cal STRIP
			XT540	#4 YEL .27cal STRIP			XT540	#4 YEL .27cal STRIP
			COBRA	#4 YEL .27cal STRIP			COBRA	#4 YEL .27cal STRIP
2 x 4, 2 x 6 LUMBER	2-1/2	N.R.	RA27	N.R.	1-7/8	N.R.	RA27	N.R.
			XT540	#4 YEL .27cal STRIP			XT540	#4 YEL .27cal STRIP
			COBRA	#5 RED .27cal STRIP			COBRA	#5 RED .27cal STRIP
1/2" PLYWOOD	1-1/4	N.R.	RA27	#4 YEL .27cal STRIP	1	N.R.	RA27	#4 YEL .27cal STRIP
			COBRA	#4 YEL .27cal STRIP			COBRA	#4 YEL .27cal STRIP
			XT540	#4 YEL .27cal STRIP			XT540	#4 YEL .27cal STRIP
3/4" PLYWOOD 1 x 4, 1 x 6 WOOD	1-1/2	N.R.	RA27	#4 YEL .27cal STRIP	1-1/4	N.R.	RA27	#4 YEL .27cal STRIP
			COBRA	#4 YEL .27cal STRIP			COBRA	#4 YEL .27cal STRIP
			XT540	#4 YEL .27cal STRIP			XT540	#4 YEL .27cal STRIP
1/2" or 5/8" GYPSUM SHEATHING	-	N.R.	N.R.		-	N.R.	N.R.	

NOTES:

- 1) This chart is presented as a guide only. Start with the lightest load available. If the fastener does not completely set, use the next higher load and repeat the process.
- 2) Product suggestions may not be suitable for all types of base materials.
- 3) N.R. is Not Recommended

POWDER FASTENER & LOAD SELECTION CHART

CONCRETE BLOCK				MORTAR JOINT (horizontal only)				LIGHT GAGE STEEL 18-12gauge			
FASTENER LENGTH (inches)	GAS TOOL	POWDER TOOL	POWDER LOAD	FASTENER LENGTH (inches)	GAS TOOL	POWDER TOOL	POWDER LOAD	FASTENER LENGTH (inches)	GAS TOOL	POWDER TOOL	POWDER LOAD
1	TF1200 T3MAG	R25	#3 GRN .25cal STRIP	1	TF1200 T3MAG	R25	#3 GRN .25cal STRIP	-	N.R.	N.R.	
		RA27	#3 GRN .25cal STRIP			COBRA	#3 GRN .27cal STRIP				
1	TF1200 T3MAG	RA27	#3 GRN .27cal STRIP	1	TF1200 T3MAG	RA27	#3 GRN .27cal STRIP	-	N.R.	N.R.	
		COBRA	#3 GRN .27cal STRIP			COBRA	#3 GRN .27cal STRIP				
		R25	#3 GRN .25cal STRIP			R25	#3 GRN .25cal STRIP				
1	TF1200 T3MAG	RA27	#3 GRN .27cal STRIP	1	TF1200 T3MAG	RA27	#3 GRN .27cal STRIP	-	N.R.	N.R.	
		COBRA	#3 GRN .27cal STRIP			COBRA	#3 GRN .27cal STRIP				
		XT540	#3 GRN .27cal STRIP			R25	#3 GRN .25cal STRIP				
2-1/2	N.R.	RA27	N.R.	2-1/2	N.R.	RA27	N.R.	-	N.R.	N.R.	
		XT540	#3 GRN .27cal STRIP			XT540	#3 GRN .27cal STRIP				
		COBRA	#4 YEL .27cal STRIP			COBRA	#4 YEL .27cal STRIP				
1-1/2	TF1200	RA27	#3 GRN .27cal STRIP	1-1/2	TF1200	RA27	#3 GRN .27cal STRIP	1-1/2	TF1200 G2	N.R.	
		COBRA	#3 GRN .27cal STRIP			COBRA	#3 GRN .27cal STRIP				
2	N.R.	RA27	#3 GRN .27cal STRIP	2	N.R.	RA27	#3 GRN .27cal STRIP	1-1/2	TF1200 G2	N.R.	
		COBRA	#3 GRN .27cal STRIP			COBRA	#3 GRN .27cal STRIP				
		XT540	#3 GRN .27cal STRIP			COBRA	#3 GRN .27cal STRIP				
-	N.R.	N.R.		-	N.R.	N.R.		1-1/2	G2	N.R.	

TRAKFAST TF1200



- **Part Number:** TF1200
- Gas Technology
- Fully Automatic
- 1-1/2" Pin Capacity
- 42 Pin Magazine Capacity
- Length: 17.5"
- Height: 15"
- Weight: 8.3 lbs.
- Maximum Capacity: 42 pins
- Maximum cycles/second: 2
- Fuel cell: 1000 shots
- Battery (charged): 3000 shots

ADVANTAGES

- **SPEED:** Three to five times faster than powder tools. 42-pin magazine reduces load time.
- **EASY TO USE:** Tool automatically resets piston. No recoil, tool absorbs shock resulting in less operator fatigue.
- **NO LICENSING REQUIRED:** Unlike powder-actuated tools, no licensing is required.
- **NO CHANGING LOADS:** TrakFast uses a fuel cell, not a load. No need to inventory different colored loads
- **NARROW NOSE & PROFILE:** Allows tool to reach inside deep leg track (1-5/8" wide x 2" high).
- 2 Year Warranty (6 months on wearable parts).

FEATURES

Still the most revolutionary fastening system in the construction industry!

Since its introduction in 1991, TrakFast has been the tool of choice for both interior and exterior contractors. The TrakFast Automatic Fastening System fastens all types of track, from standard track to hat channel, deep leg, Z, and J channel. Contractors continue to report tremendous savings when using TrakFast for high production fastening. They have learned that TrakFast's actual cost in place beats all other systems. The increased speed and productivity of TrakFast allows the contractor to bid more competitively, complete the job sooner and move on to the next job. Anyone can use TrakFast—just load the pins and fire. It's that easy!

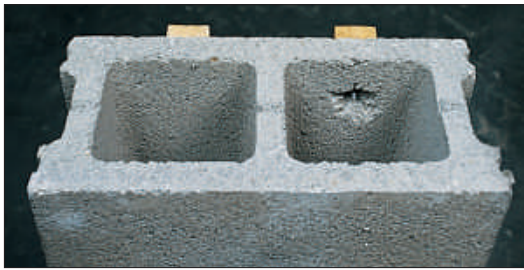

TrakFast ICC ESR-2579 is the only approval that allows you to fasten into any location on a hollow block wall and won't blow away block like a powder tool.

TrakFast's power comes from the battery and fuel cell

The 6-volt rechargeable Ni-CD battery can drive approximately 3000 shots per charge. The clean burning fuel cell can drive over 1000 pins and keeps the tool cleaner than powder actuated tools.

Fastening System Productivity

In the time it takes you to drive two pins with a powder tool, you can drive up to 10 pins with TrakFast!



MOST COMMON FASTENERS

PIN #	PIN LENGTH		MOST COMMON APPLICATION
	IN.	(MM)	
FPP012S	1/2	12.7	Track to steel
FPP034B	3/4	19.1	Track to concrete



APPLICATIONS



Track to steel



Lath attachment—using one-inch TrakFast discs and magnetic probe adapter



Furring attachment—perfect fastening every time in soft and hard base materials



Plywood attachment—using TrakFast plywood to steel pin



Track to concrete

T3MAG



- **Part Number: T3MAG**
- Gas Technology
- 45-Pin Magazine
- One Step Fuel Injection
- Fully Automatic
- Length: 18-1/2"
- Height: 15"
- Weight: 9.2 lbs.
- Pin Guide O.D.: .590
- Maximum Pin Length: 1"

ADVANTAGES

- Higher stick rate
- 25% more power
- Easy push down force
- Deep leg track capacity
- 45-pin magazine capability
- Fitted dust shield
- Battery charger provides constant charging even with low voltage drops
- 2 Year Warranty or 50,000 shots (6 months on wearable parts or 10,000 shots)
- No License Required

FEATURES

T3MAG Increase Your Range with Overhead Power

The Power of the T3MAG allows you to consistently shoot where no other gas tool has gone before. The .125 diameter pin is specifically engineered to work in the toughest concrete and steel where other pins cannot perform. The T3MAG system delivers power that rivals other gas and powder systems.

FUEL CELL AND BATTERY

T3 Fuel Cell

Part No. T3FUEL

Replaces conventional powder loads and drives more than 1000 pins



Fuel injection means no additional steps of preparing a fuel cell. Click the fuel cell in place and the tool is ready to go.



T3 Battery

Part No. B0092

The 6-volt Ni-Cd battery can drive more than 3000 shots per charge

MOST COMMON FASTENERS

PIN #	DESCRIPTION
T3012	1/2" steel pin with T3 fuel cell
T3012S	1/2" premium steel pin with fuel cell
T3034B	3/4" concrete pin with T3 fuel cell
T3034S	3/4" step shank pin with T3 fuel cell
T3100	1" concrete pin with T3 fuel cell



Easy battery loading. Battery rest position allows you to turn off the tool without fully removing the battery.



VIDEO AVAILABLE

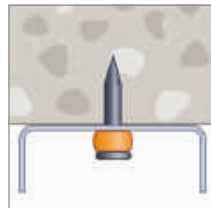

Settling aggregate is the biggest reason for overhead pin failure.

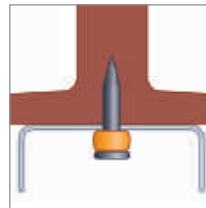

With the T3's 1/2 steel pin you can even shoot into the web of steel.

APPLICATIONS



The T3 has enough power to fasten into hard concrete and steel and still will not blow through hollow block.

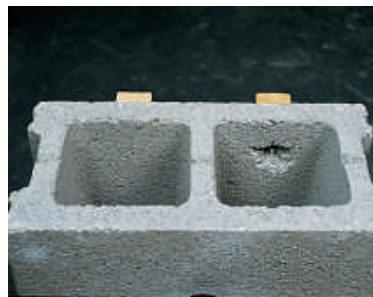

Will not spall hollow block like powder actuated.



Perfect for hat channel applications.

T3SS



VERSATILE, fastens to solid concrete, hollow block, pan deck and steel.



- **Part Number: T3SS**
- Gas Technology
- Single Pin Gas Tool
- Fuel Injection
- Cross Over Technology
- 2 Year Warranty (6 months on wearable parts)
- Length: 13-1/2"
- Height: 15"
- Weight: 7.0 lbs.
- Pin Guide O.D.: 1/2" Standard, 7/8" Magnetic
- Maximum Pin Length: 1-1/2"

ADVANTAGES

- Sets the standard for single-shot applications
- 5 times faster than traditional drill and anchor methods
- Replaces the need for tools like the DX35
- Reduced operator fatigue
- Reduced installation costs—up to 75%
- Quiet enough to work in tenant occupied buildings
- Removable rear foot
- Interchange nose

FEATURES

CROSSING OVER FROM POWDER TO GAS

Ramset is serious when it comes to driving job speed by creating the T3SS—the single shot tool that will help move contractors from powder to gas.

The T3SS provides the benefits of shooting a gas tool, including reduced installation time and operator fatigue for the contractor who normally shoots a muzzle loaded powder tool.

To make the T3SS the most versatile gas tool in the industry, users can change out nosepieces to accommodate any fastening need. From metal-to-concrete, hard concrete or steel, pan deck, block and just about surface you can think of the T3SS works for you.



No more fines for unspent loads on the jobsite.

APPLICATIONS

FASTENER AND MAGNETIC NOSEPIECE



The optional interchangeable nosepiece (Part Number M150200) is able to shoot a variety of M series fasteners.

T3CUP



MOST COMMON FASTENERS

PIN #	DESCRIPTION
12HSMPO34	1/2" One hole strap with 3/4" pin
MP034TH	3/4" Plated pin with top hat
M100	1" Pin with gold domed washer
14THRMP034	1/4" Threaded rod hanger

FUEL CELL AND BATTERY

T3 Fuel Cell

Part No. T3FUEL

Replaces conventional powder loads and drives more than 1000 pins



Fuel injection means no additional steps of preparing a fuel cell. Click the fuel cell in place and the tool is ready to go.



T3 Battery

Part No. B0092

The 6-volt Ni-Cd battery can drive more than 3000 shots per charge



VIDEO AVAILABLE



12HSMPO34 clip assembly used to secure conduit



M034 fastener used to hang HVAC Duct Strap



M100 fastener used to attach a junction box



Easy battery loading. Battery rest position allows you to turn off the tool without fully removing the battery.

GYPFAST G2



Fully Automatic Cordless Gas Fastening System for Attaching Exterior Sheathing to Light Gauge Steel Framing

- **Part No.:** G2
- Fully Automatic
- 2-1/2" Pin Capacity
- Length: 15"
- Height: 15.25"
- Weight: 7.6lbs. with battery
- Lengths: 1-1/2", 2" and 2-1/2"
- Pin Diameter: .140" Nominal
- Head Style: 5/16" dia. bugle head
- Finish: Climacoat Long Life Polymer

ADVANTAGES

- Exterior Gypsum sheathing to steel framing
- Plywood and OSB sheathing/flooring
- Fiber cement panel attachment
- Blocking
- Exterior walls
- Windows/door bucks
- Specialty exterior sheathing attachment
- Woven wire mesh or expanded metal lath to steel framing

FEATURES

- Fully automatic system with 150 nail capacity is 3-5 times faster than screwing.
- Fast set-up and tear down – insert battery, fuel cell and nail coil – eliminates need for extension cord, hoses and compressors.
- Aggressive, patented nail shank design provides high pullout performance.
- Contoured bugle head style provides high pullover (wind) resistance.
- Long life Climacoat™ finish is 10 times more corrosion resistant than electro-zinc plating.
- Woven wire mesh or expanded metal lath to steel framing
- 2 year warranty

Fuel cell

Part No. TFUEL



T3 Battery

Part No. B0092



Plated 1" Lathing Disc

Part No. LD100



MOST COMMON FASTENERS

PIN #	.140" DIA. KNURLED SHANK 5/16" DIA. BUGLE HEAD		MASTER CARTON	APPLICATION
	IN.	(MM)		
GF112	1-1/2	38.1	6,000 nails/ctn (40- 150 ct. coils) 6 fuel cells	Single Layer of Exterior Sheathing, Wood Furring and Blocking
GF200	2	50.8	4,800 nails/ctn (32 - 150 ct. coils) 5 fuel cells	Double Layer of Exterior Gypsum Sheathing, Wood Furring and Blocking
GF212	2-1/2	63.5	2,700 nails/ctn (18 - 150 ct. coils) 3 fuel cells	Multi-Layers of Sheathing, Wood Blocking, and Dimensional Lumber

APPLICATIONS



Exterior Gypsum sheathing to steel framing, Plywood and OSB sheathing/flooring, Fiber cement panel attachment, Blocking Exterior walls, Windows/door bucks, Specialty exterior sheathing attachment, Woven wire mesh or expanded metal lath to steel framing.

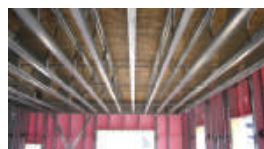

OSB and plywood to iSPAN joists

RAMSET T4 I-F



The Ramset T4 I-F System is 4 times faster than the traditional stick pin installation method. It allows the installer to attach insulation in one simple step without the use of adhesives or cutting spindle insulation anchors anymore

White
for concrete and block

Black
for steel and wood



FUEL CELL AND BATTERY

T4 Fuel Cell / Part No. T4FUEL

Replaces conventional powder loads and drives more than 1000 pins



Fuel injection means no additional steps of preparing a fuel cell. Click the fuel cell in place and the tool is ready to go.

T4 Battery / Part No. 18581

The 6-volt Ni-Cd battery can drive more than 3500 shots per charge



- **Part No.: T4 I-F**
- Single shot gas tool
- One step fuel injection & eject
- Length: 15"
- Height: 15.25"
- Weight: 7.6lbs. with battery
- 2 year warranty
- Operating Temperature: 5°F to 122°F

ADVANTAGES

- Saves days over the traditional insulation fastening method saving time and labor costs.
- Safer than stick pins, powder actuated, and screw fastening methods.
- Fasten the insulation directly to concrete, hollow block, and steel studs. No need to glue and stick pin insulation anchors anymore.
- Tool allows you to fasten the insulation in tight spaces through pipes and sprinkler systems.
- The system can be used year round: unlike stick pins you won't be restricted by cold temperatures or wet surfaces.
- The T4FUEL can shoot more than 1000 shots before it needs to be replaced.
- Lower operator fatigue.
- 1"-6" insulation capacity.

APPLICATIONS

Most common application is fastening insulation to concrete, hollow block, and steel studs



Above acoustical ceilings



Behind cladding over wood stud walls



Foundations & basements



Behind cladding over concrete block walls



Interior walls on concrete block



Behind cladding over steel stud walls

Faster and Safer, Industry-Approved Thermal Break Fastener

Performance Tables:

CONCRETE

PART NUMBER SERIES	CONCRETE STRENGTH (PSI)	ALLOWABLE/ULTIMATE TENSION LOADS (Lbs)
IFC	3600 - 6500	35 - 211

*Bold number is allowable load, second number is average ultimate load

HOLLOW CONCRETE BLOCK

PART NUMBER SERIES	ALLOWABLE/ULTIMATE TENSION LOADS (Lbs)
IFC	35 - 184

*Bold number is allowable load, second number is average ultimate load

STEEL STUDS

PART NUMBER SERIES	SHANK DIAMETER (INCH)	Installed in Cold Formed Steel Framing (lbf)					
		22 GAUGE	20 GAUGE	18 GAUGE	16 GAUGE	14 GAUGE	12 GAUGE
IFS (knurled)	0.100	20 - 120	33 - 200	46 - 280	60 - 360	62 - 371	75 - 448

*Bold number is allowable load, second number is average ultimate load

WOOD

PART NUMBER SERIES	SHANK DIAMETER (INCH)	Installed in 16/32" (1/2" nominal) 4 Ply Plywood Sheathing (lbf)
IFS (knurled)	0.100	16 - 93

*Bold number is allowable load, second number is average ultimate load

Selection Chart:

INSULATION THICKNESS	CONCRETE OR BLOCK PART NO.	STEEL OR WOOD PART NO.	BOX QTY
1"	T4IFC-100	T4IFS-100	500
1-1/2"	T4IFC-112	T4IFS-112	500
2"	T4IFC-200	T4IFS-200	500
2-1/2"	T4IFC-212	T4IFS-212	500
3"	T4IFC-300	T4IFS-300	500
3-1/2"	T4IFC-312	T4IFS-312	500
4"	T4IFC-400	T4IFS-400	500
5"	T4IFC-500	T4IFS-500	500
6"	T4IFC-600	T4IFS-600	400
Tool	T4IF	T4IF	1

Concrete



Steel



Thermal Efficiency:

		INSULATION THICKNESS					
		1 in	2 in	3 in	4 in	5 in	6 in
Reference	U-Factor (W/m ² °C)	1.1786	0.7122	0.5103	0.3976	0.3257	0.2758
	Efficiency (%)	100.00%	100.00%	100.00%	100.00%	100.00%	100.00%
Stick Pin	U-Factor (W/m ² °C)	1.2442	0.7706	0.5597	0.4397	0.3621	0.3078
	Efficiency (%)	94.88%	92.42%	91.17%	90.43%	89.94%	89.9659
Ramset I-F	U-Factor (W/m ² °C)	1.1845	0.7162	0.5132	0.3999	0.3276	0.2773
	Efficiency (%)	99.50%	99.45%	99.44%	99.43%	99.42%	99.42%

Fastener Specifications:

- Pin Material: Heat treated carbon steel
- Pin Finish: Mechanical Zinc Plated
- Washer Material: High Density Polyethylene (HDPE)
- 2-3/8" Washer Diameter
- The fastener assembly is clearly branded Ramset along with the length of the fastener assembly

Ramset I-F will attach:



Mineral Wool



Extruded Polystyrene



Expanded Polystyrene



Fiberglass



Polyisocyanurate

Effective Fastener Length: 3/4" for IFC- / 1-1/2" for IFS-

Washer Diameter 2-3/8"

Large bearing surface keeps insulation from sagging



Integrated Cap
Closed cap creates thermal break



Washer Point
Designed to pierce dense insulation material

RA27

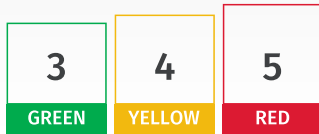
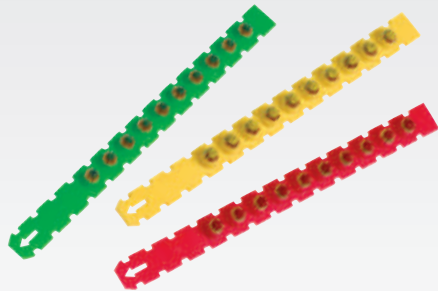

POWDERLOAD IDENTIFICATION

Lower Power → Higher Power



Part No. RA27MAG

Works with collated True Embedment (TE_X) Pins

Ramset's fully automatic RA27 powder-actuated tool, lowering downtime and fatigue on commercial jobsites. The RA27 stands up to tough use for interior and exterior applications:

- Track-to-Concrete
- Track-to-Steel
- Exterior Cladding Clips
- Deep Leg Track
- Electrical/Unistrut
- Hat Channel

RA27 TOOL SPECIFICATIONS

- **Part number:** RA27
- Weight: 5.3 lbs
- Maximum pin length without washer: 1½"
- Maximum pin length with washer: 2"
- 3-year warranty
- For use with .27 caliber loads (green, yellow, red)

RA27MAG MAGAZINE SPECIFICATIONS

- **Part number:** RA27MAG
- Weight: 1.3 lbs
- Maximum pin length: 1¼"

ADVANTAGES

- Lower pushdown force reduces fatigue
- Long-lasting piston reduces downtime
- Collar requires only ¼ turn for quicker cleaning
- More power load-for-load provides flexibility in a wide range of applications
- Swing out scaffold hook keeps the tool within reach
- Power adjust dial enables user to dial down power for ideal pin embedment
- Patented RRC (Residue Release Channel) allows tool to work longer between cleanings.
- Back end padding absorbs recoil, lowering fatigue
- Durable magazine providing up to 30% longer lifespan
- Belt/tether clip for safety



MOST COMMON FASTENERS – TRUE EMBEDMENT PINS

PART #	PIN LENGTH		EMBEDMENT LENGTH		MASTER CARTON QTY
	IN.	(MM)	IN.	(MM)	
TE12	9/16	(13.8)	1/2	(12.7)	5000
TE34	13/16	(20.6)	3/4	(19)	5000
TE100	1-1/16	(27)	1	(25.4)	5000
TE114	1-5/16	(33.3)	1-1/4	(31.6)	1000

Shank diameter = .157 Head diameter = .320

COLLATED TRUE EMBEDMENT PINS

PART #	PIN LENGTH		EMBEDMENT LENGTH		MASTER CARTON QTY
	IN.	(MM)	IN.	(MM)	
TE12X	9/16	(13.8)	1/2	(12.7)	5000
TE34X	13/16	(20.6)	3/4	(19.1)	5000
TE100X	1-1/16	(27)	1	(25.4)	5000
TE114X	1-5/16	(33.3)	1-1/4	(31.8)	5000

Shank diameter = .157 Head diameter = .320

COMMON REPLACEMENT PART – AVAILABLE AT ITW SERVICE AND PARTS

- 751321 Piston



XT540



Durable, Reliable, Powerful, Automatic

XT540

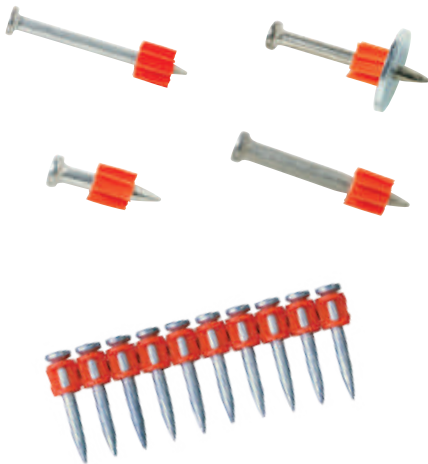

The most powerful tool in its class

The Ramset XT540 was specifically designed for the commercial framer for heavy-duty interior & exterior applications. The XT540's combination of high power and durability make it perfect for these applications:

- Driving 1-1/4" embedment for perimeter track
- Fastening track & clips to structural steel
- Track to hard concrete
- Excellent compliment to your Ramset TrakFast program

FEATURES

- **Part Number: XT540**
- .27 Caliber Strip Tool
- Automatic Piston Return
- Power Adjust Dial
- 3" Pin Capacity
- 3 Year Warranty
- .27 Caliber Strip Loads: 3 (Green), 4 (Yellow), 5 (Red)
- Weight: 7.25 lbs.
- Length: 19"
- Muzzle Bushing O.D.: 7/8"

ADVANTAGES

- Very Powerful
- Spring return front end—no manual resetting of the piston
- Power adjust—dial down 2 full load levels
- Rugged soft grip handle
- Trigger lock & hand guard to increase safety
- Low recoil
- Ergonomically balanced
- Works with Magnetic Muzzle (Part# 100227) & Lathing Discs

MOST COMMON FASTENERS

PIN #	SHANK LENGTH		MOST COMMON APPLICATION
	IN.	(MM)	
SP58TH	5/8	15.9	Track to steel
TE114	1-1/4	31.8	Track to concrete
SP114	1-1/4	31.8	Track to concrete

COMMON REPLACEMENT PART – AVAILABLE AT ITW SERVICE AND PARTS

- PA37037 Piston
- 010542 Piston Return Spring



Part No. XTMAG

Works with collated True Embedment (TE) Pins



COBRA



- **Part Number: COBRA**
- .27 Caliber Strip Tool
- Semi-Automatic
- Economical
- .27 caliber 10-shot strip loads: 3 (Green), 4 (Yellow), 5 (Red)
- Weight: 5.0 lbs.
- Length: 13-1/4"
- Muzzle Bushing O.D.: 9/16"
- Maximum Pin Length: 2-1/2" (3" w/washer)

ADVANTAGES

- Semi-automatic .27-caliber tool — uses strip loads
- Padded recoil-absorbing handle — for greater operator comfort
- Fastens up to 3" standard Ramset drive pins and threaded studs—ideal for general construction applications
- 1 Year Warranty

MOST COMMON FASTENERS

PIN #	SHANK LENGTH		MOST COMMON APPLICATION
	IN.	(MM)	
1516SDC (washed)	2-1/2	63.5	2" x 4" to concrete
1524SDP(washed)	3	76.2	2" x 4" to concrete
SP58TH	5/8	15.9	Track to steel

COMMON REPLACEMENT PART – AVAILABLE AT ITW SERVICE AND PARTS

- SC301200A Piston and Ring



VIDEO AVAILABLE

R25



- .25 Caliber Strip Tool
- Semi-Automatic
- .25 Caliber Strip Loads: 3 (Green), 4 (Yellow), 5 (Red)
- Weight: 4.3 lbs.
- Length: 11.6"
- Maximum Pin Length: 1-1/2"
- 1 Year Warranty

ADVANTAGES

- Rugged metal housing
- Rubber cushion grip
- Popular drywall track tool
- 1 Year Warranty

MOST COMMON FASTENERS

PIN #	SHANK LENGTH		MOST COMMON APPLICATION
	IN.	(MM)	
1506B	3/4	19.0	Track to concrete
SP58TH	5/8	15.9	Track to steel

COMMON REPLACEMENT PART – AVAILABLE AT ITW SERVICE AND PARTS

- SC325207A Piston Assembly

VIPER4



- **Part Number: VIPER4**
- .27 Caliber Strip Tool
- Semi-Automatic
- Designed Specifically for Overhead Applications
- 3 Year Warranty
- .27 caliber 10-shot strip loads: 3 (Green), 4 (Yellow), 5 (Red)
- Weight: 4.9 lbs.
- Length: 17.25"
- Maximum Pin Length: 1-1/2"

ADVANTAGES

- **Automatic load advance:** Load is advanced consistently each time the Viper is fired.
- **Automatic Piston return:** No time spent manually resetting or cycling the tool. Allows you to work faster.
- **Overdrive Protection:** Heavy duty buffer system prevents front end damage caused by piston overdrive —especially through sprayed-on insulation.
- **Open Front-end design:** Completely redesigned open-ended muzzle keeps your tool cleaner longer.
- **Simplified Barrel Retention Collar:** No tools are required for assembly or disassembly.
- **Stable Steel Collar:** The VIPER4 screws securely into the end of the extension pole with the steel collar ensuring a more durable and rigid connection.

FASTENERS

- **ELECTRICAL PIN/CLIP ASSEMBLIES**
Preassembled Pin & Clips for some of the most common electrical applications increase jobsite speed for the electrician.
- **STANDARD PIN/CLIP ASSEMBLIES**
SDC Fasteners are designed with special dimples on the angle clips which act as a shim and assure a snug fit between the structural member and the clip.
- **POWERPOINT® PIN/CLIP ASSEMBLIES**
SPC Fasteners are assembled with the patented technology of PowerPoint pins for penetration in hard concrete and steel. The uniform shape and finish of the engineered tip results in more consistent performance in your toughest situations.



VIDEO AVAILABLE



TOOL/POLE CONNECTION

The new poles have an internal rod, when activated by pushing on the pole sleeve triggers the new VIPER4.

PART NUMBER	DESCRIPTION
V4-6	6' Pole
V4-8	8' Pole
V4-EXT	3' Extension (no trigger)

*Telescoping poles are NOT available for the VIPER4.

MOST COMMON FASTENERS

PIN #	SHANK LENGTH		MOST COMMON APPLICATION
	IN.	(MM)	
14TRHSS10	1	25.4	Threaded Rod Hanger
SDC125	1-1/4	31.8	Ceiling Clip
SPC114	1-1/4	31.8	Ceiling Clip

COMMON REPLACEMENT PART – AVAILABLE AT ITW SERVICE AND PARTS

- MVP140 Piston

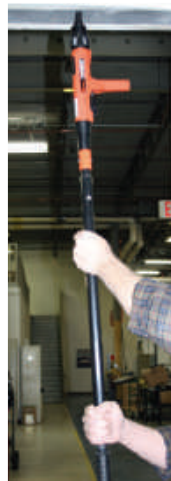

The Viper4 screws solidly onto a pole for high reach and secure operation for ceiling applications.

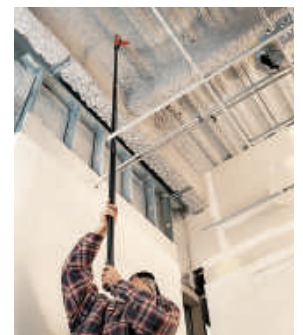

The Viper was engineered specifically for overhead applications.

POLE TOOLS & CUPS



Cup and pole sold separately

FEATURES

- Pole tools allow to easily fasten in overhead applications safely from the floor.
- Eliminate the need for ladders and scaffolding.
- Cup accessories designed to ergonomically balance the tools directly over the poles for a lightweight feel.

EASY TO ASSEMBLE



PART NUMBER	DESCRIPTION
T3CUP	T3 Cup
T4CUP	T4 Cup
RA27CUP	RA27 Cup

PART NUMBER	DESCRIPTION
V4-6	6' Pole
V4-8	8' Pole
V4-EXT	3' Extension (no trigger)

Uses VIPER4 pole system:

Works with three newly designed Ramset poles for greater ease and accuracy.



TOOL/POLE CONNECTION

The pole has a unique internal rod that when activated by pushing on the pole sleeve triggers the VIPER4.



EXTENSION POLES

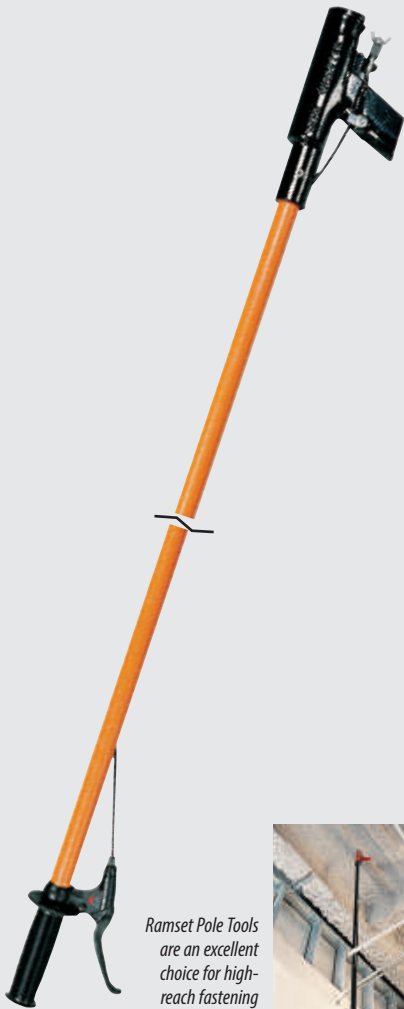

Ramset Pole Tools are an excellent choice for high-reach fastening applications.



Fast, easy installation from floor level eliminates lift baskets, scaffolds and ladders.

ADVANTAGES

- Eliminates scaffolding or ladders
- Uses existing powder tools
- Rubber "motorcycle" grip for operator comfort and to reduce recoil level
- Delrin™ coupler on cable makes pole di-electric
- Nyloc™ nuts keep your adjustment fixed solidly on the trigger bar
- Top-quality hand lever
- Lightweight cast aluminum housing fits tool snugly and provides tool protection
- Trigger bar adjusts easily for individual tools

POLE FOR RAMSET AND HILTI® TOOLS

PART #	LENGTH
PLSEM18	8'

FITS: RAMSET D60, SA270, D45A, Rocket, Cobra, **HILTI** DX36
 Hilti® is a registered trademark of Hilti, Corp.



POLES FOR RAMSET VIPER4

PART #	LENGTH
V4-6	6'
V4-8	8'
V4-EXT	3' Extension (no trigger)



ACCESSORIES



Part No. TFUEL
Fuel Cell for TrakFast (TF1100, TF1200) Gypfast, G2
Qty: 12



Part No. T4FUEL
Fuel Cell for T4SS & T4MAG, T4 I-F
Qty: 12 (3-4 packs)



Part No. T3FUEL
Fuel Cell for T3SS & T3MAG
Qty: 12 (6-2 packs)



Part No. 7505012
Battery for TF1100
Qty: 1



Part No. B0092
Battery for T3SS & T3MAG, TF1200, G2, T3IF-6
Qty: 1



Part No. 18581
Battery for T4 I-F
Qty: 1



Part No. 906014
Battery Charger Kit for TF1200, T3SS, T3MAG, T3IF-6, & G2
Qty: 1



Part No. LD100
Plated 1" Lathing Disc 22g
Qty: 1,000 per box
Works with all magnetic probes

ACCESSORIES – NOW AVAILABLE AT ITW SERVICE & PARTS



Part No. 100041LA
Disc Holding Probe for TF1200 Probe
Qty: 1



Part No. M150200
Magnetic nose Piece for T3SS
Qty: 1



Part No. 906001
Disc Holding Probe for T3MAG
Qty: 1



Part No. 100227*
Magnetic Muzzle for XT540
Qty: 1

For other service parts, please contact Tool Repair and Parts at www.itwconstructionparts.com

Fastener Selection Table of Contents

Track to Concrete, Block & Steel (TF1200)	28
Plywood to Metal Studs (TF1200)	28
Track to Concrete, Block & Steel (T3MAG)	29
Exterior Sheathing to Metal Studs (G2)	29
Fasteners Designed for Use in T3SS	30
Fasteners Designed for Use in Powder Actuated Tools	32
Ceiling Clips / Angle Clips	34
Specialty Fasteners Designed for Powder Actuated Tools	35
Powder Actuated Loads	36



Ramset Collated Gas Tool Fasteners are specifically engineered for optimal performance in Ramset Gas Power Tools using fastener magazines.

SELECTION CHART



TRAKFAST STANDARD FUEL/PIN PACK

1000 PINS AND 1 FUEL CELL PER BOX

For high volume, repetitive fastenings to concrete and steel such as drywall track to concrete

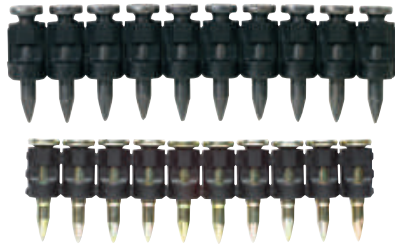

PART NUMBER	PIN LENGTH		DESCRIPTION
	IN.	(MM)	
FPP012	1/2	(12.7)	1/2" Plated steel pin
FPP012S*	1/2	(12.7)	1/2" Premium Plated step shank pin
FPP034B	3/4	(19.1)	3/4" Black pin
FPP034S*	3/4	(19.1)	3/4" Premium Plated step shank pin
FPP100	1	(25.4)	1" Plated pin
FPP114	1-1/4	(31.8)	1-1/4" Plated Pin

Shank diameter = .109 * Shank diameter = .104/.118 Head diameter = .250
 Sold in master cartons of 5000 minimum. Cartons cannot be split.

TRAKFAST BREAKAWAY STRIP FUEL/PIN PACK

1000 PINS AND 1 FUEL CELL PER BOX

Collation designed to breakaway on impact.

For high volume, repetitive fastenings to concrete such as wood furring to concrete



PART NUMBER	PIN LENGTH		DESCRIPTION
	IN.	(MM)	
FPP034T	3/4	(19.1)	3/4" Plated pin
FPP100T	1	(25.4)	1" Plated pin
FPP114T	1-1/4	(31.8)	1-1/4" Plated Pin
FPP112T	1-1/2	(38.1)	1-1/2" Plated Pin

Shank diameter = .109 Head diameter = .250
 Sold in master cartons of 5000 minimum. Cartons cannot be split.

TRAKFAST PLYWOOD PIN

1000 PINS AND 1 FUEL CELL PER BOX

For attaching plywood to metal studs



PART NUMBER	PIN LENGTH		DESCRIPTION
	IN.	(MM)	
PLY138	1-3/8	(34.9)	1-3/8" Plated pin (knurled)

Shank diameter = .109 Head diameter = .250 Helical knurled shank Mechanical zinc plated
 Sold in master cartons of 5000 minimum. Cartons cannot be split.



ADVANTAGES

VS SCREWS

- 3 - 5 times faster than screw installation. No worrying about electrical cords.

STRIP

- Collation strip breaks away upon impact, allowing the head of the pin to recess into the wood for a nice, clean look
- 10-pin strips transfer easily from the operator's pouch to the TrakFast tool, eliminating waste

VS AIR SYSTEMS

- No set-up and tear down time. No hassling with compressors or hoses.

PINS

- Hardened steel pin ensures a clean penetration of the fastener — no dimpling of the stud
- Knurled helical shank gives the fastener superior holding values
- Zinc plated for corrosion resistance



T3MAG FUEL/PIN PACK

1000 PINS AND 1 FUEL CELL PER BOX

SELECTION CHART

Larger .125 shank diameter offers improved success rate (15 pin strip)



PART NUMBER	PIN LENGTH		DESCRIPTION
	IN.	(MM)	
T3012	1/2	(12.7)	1/2" steel pin with T3 fuel cell
T3012S	1/2	(12.7)	1/2" premium steel pin with T3 fuel cell
T3034B	3/4	(19.1)	3/4" concrete pin with T3 fuel cell
T3034S*	3/4	(19.1)	3/4" step shank pin with T3 fuel cell
T3100	1	(25.4)	1" concrete pin with T3 fuel cell

Shank diameter = .125 *Shank diameter = .104/.125 Head diameter = .250
 Sold in master cartons of 5000 minimum. Cartons cannot be split.



GYPFAST / G2 FASTENERS

For attaching exterior sheathing, both gypsum and plywood, to metal studs

PART NO.	FASTENER DESCRIPTION .140" DIA. KNURLED SHANK 5/16" DIA. BUGLE HEAD	MASTER CARTON QUANTITY	MASTER CARTON WEIGHT	APPLICATIONS
GF200	2" (51mm)	4,800 nails/ctn (32 - 150 ct. coils) 5 fuel cells	38 lbs.	Double Layer of Exterior Gypsum Sheathing, Wood Furring and Blocking
GF212	2-1/2" (64mm)	2,700 nails/ctn (18 - 150 ct. coils) 3 fuel cells	26 lbs.	Multi-Layers of Sheathing, Wood Blocking, and Dimensional Lumber



CLIMACOAT COATING ALLOWS FOR USE IN:

- Exterior applications
- Treated Lumber
- Treated Plywood
- Fire Resistant Plywood
- 20g to 14g applications

T3SS SINGLE SHOT TOOL



The fasteners are designed for use in Ramset T3SS Single-Shot Gas Tool

SELECTION CHART

THREADED ROD HANGER

For suspended ceilings, piping and other items using 1/4" or 3/8" threaded rod. Fastener is pre-assembled to a 16 gage threaded rod hanger. 100 per jar.

	PART NUMBER	DESCRIPTION	MASTER CARTON QUANTITY
	14TRHMP034	1/4" Rod hanger with 3/4" plated pin	800
38TRHMP034	3/8" Rod hanger with 3/4" plated pin	800	

Shank diameter = .104/.125 Head diameter = .300

ONE HOLE STRAP

Used to attach EMT conduit or armored cable to concrete. Fastener pre-assembled to a 16 gage conduit strap. 100 per jar, 3/8" 200 per jar.

	PART NUMBER	DESCRIPTION	MASTER CARTON QUANTITY
	38HSMPO34*	3/8" Hole strap with 3/4" plated pin	1200
12HSMPO34	1/2" Hole strap with 3/4" plated pin	800	
34HSMPO34	3/4" Hole strap with 3/4" plated pin	600	
10HSMPO34	1" Hole strap with 3/4" plated pin	600	

Shank diameter = .104/.125 Head diameter = .300 *38HSMPO34 = 18 gage, 200 per jar

CONDUIT CLAMP

Used to attach conduit to concrete. Pin pre-assembled to an 18 gage conduit strap. 3/4" 25 per jar.

	PART NUMBER	DESCRIPTION	MASTER CARTON QUANTITY
	34CCMP034L	3/4" Conduit clamp with 3/4" plated pin	300

Shank diameter = .104/.125 Head diameter = .300

CEILING CLIP ASSEMBLY

Pre-assembled Ceiling Clip. Plated 14 gage clip. 100 per jar.

	PART NUMBER	DESCRIPTION	MASTER CARTON QUANTITY
	34CLIP	3/4" wide angle clip w/ 3/4" length pin	800

Shank diameter = .104/.125 Head diameter = .300 Hole diameter = 5/16"

AVAILABLE IN CONVENIENT JARS!

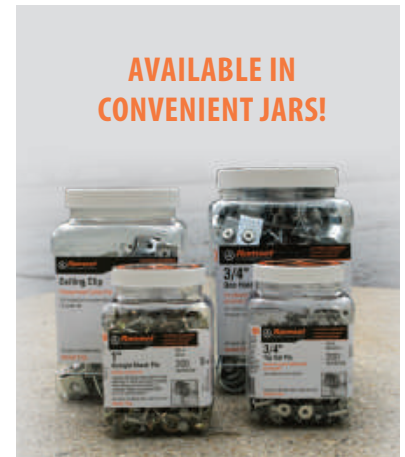

The new durable plastic containers mean less waste on the jobsite, or in the back of a truck. Their wide-mouth design makes it easy to grab what you need.



Each T3SS gas accessory and pin label provides vital holding value information—taking away the guess work.

T3SS SINGLE SHOT TOOL

The fasteners are designed for use in Ramset T3SS Single-Shot Gas Tool



SELECTION CHART

TIE STRAP HOLDER

Used to install temporary lighting and secure low voltage cable to concrete, uses a standard cable tie up to 3/8" in width. Fastener is pre-assembled to a 22 gage tie strap holder. 50 per jar.



PART NUMBER	DESCRIPTION	MASTER CARTON QUANTITY
TSHMP034	Tie strap holder with 3/4" plated pin	1250

Shank diameter = .104/.125 Head diameter = .300

MECHANICAL PIN WITH WASHER

Used for the attachment of light gage metal to concrete and steel such as HVAC duct strap to concrete. Plated pin pre-assembled to a 1/2" domed washer. 200 per jar, 1" 100 per jar.

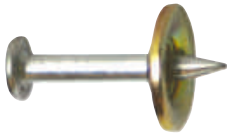

PART NUMBER	DESCRIPTION	MASTER CARTON QUANTITY
M034	3/4" Plated pin with domed washer	5000
M034BB	3/4" Premium step pin with domed washer	5000
M100	1" Plated pin with domed washer	5000

MUST USE WITH MAGNETIC WORK CONTACT ELEMENT (M150200)

TOP HAT PIN

Used for general purpose fastening to concrete. Plated pin with top hat. 200 per jar.



PART NUMBER	DESCRIPTION	MASTER CARTON QUANTITY
MPO34TH	3/4" Plated pin with top hat	5000

Shank diameter = .125 Head diameter = .300

We maintain only the highest standards in the materials, production techniques and quality control measures used to manufacture our fasteners, assuring consistent, optimum quality in every fastener.

FASTENER TERMINOLOGY SUFFIX

K = Knurled X = Collated C = 100 count
 B = Black SD = Washer M = 1000 count
 E = Ramguard TH = Top Hat

ADVANTAGES

ITW Ramset powder actuated fasteners are specifically fabricated to meet the exacting requirements of toughness and durability that enable them to penetrate dense concrete and structural quality steel. All Ramset fasteners with .300 head will fit into tools with 8mm barrels.

SELECTION CHART

BLACK TRACK PINS

Designed for use in concrete and structural steel applications. Available in 100-pack or 1000-pack per box.

	PART NUMBER	SHANK LENGTH		R25 / RA27	SA270	XT540	COBRA	MASTER CARTON QTY
		IN.	(MM)					
	1506B	3/4	(19.1)	5000

Shank diameter = .145 Head diameter = .300

PLATED PINS

Designed for use in concrete and structural steel applications. 100 per box.

	PART NUMBER	SHANK LENGTH		R25 / RA27	SA270	XT540	COBRA	MASTER CARTON QTY
		IN.	(MM)					
	1503K	1/2 Knurled	(12.7)	5000
	1506	3/4	(19.1)	5000
	1508	1	(25.4)	5000
	1510	1-1/4	(31.8)	1000
	1512	1-1/2	(38.1)	1000
	1514	2	(50.8)	800
	1516	2-1/2	(63.5)	800
	1524	3	(76.2)	600

Shank diameter = .145 Head diameter = .300

WASHERED PINS

Washer increases bearing surface against the material to be fastened. 100 per box. 16 gage metal washer. 7/8" diameter washer.

	PART NUMBER	SHANK LENGTH		R25 / RA27	SA270	XT540	COBRA	MASTER CARTON QTY
		IN.	(MM)					
	1506SD	3/4	(19.1)	1000
	1508SD	1	(25.4)	1000
	1510SD	1-1/4	(31.8)	1000
	1512SD	1-1/2	(38.1)	1000
	1514SD	2	(50.8)	1000
	1516SDC	2-1/2	(63.5)	600
	1524SDP*	3	(76.2)	600

*Square washer indicates 3" pin has been installed Shank diameter = .145 Head diameter = .300

RAMGUARD PINS

Coated to improve corrosion resistance in treated lumber and other applications. 100 per box. Recommended for treated lumber applications.

	PART NUMBER	SHANK LENGTH		R25 / RA27	SA270	XT540	COBRA	MASTER CARTON QTY
		IN.	(MM)					
	1516E	2-1/2	(63.5)	800
	1516SDE	2-1/2	(63.5)	600
	1524SDE*	3	(76.2)	600

Shank diameter = .145 *Square washer indicates 3" pin has been installed *1500 Series Coated with RamGuard Head diameter = .300

SELECTION CHART

POWERPOINT PINS

Used for fastening into harder steel and concrete. Premium steel and hard concrete pin. 100 per box.



PART NUMBER	SHANK LENGTH		R25 / RA27	SA270	XT540	COBRA	MASTER CARTON QTY
	IN.	(MM)					
SP12	1/2	(12.7)	•	•	•	•	5000
SP58	5/8	(15.9)	•	•	•	•	5000
SP34	3/4	(19.1)	•	•	•	•	5000

Shank diameter = .150 Head diameter = .300

POWERPOINT STEP SHANK PINS

Used for fastening into harder steel and concrete. Premium steel and hard concrete pin. Pin for fastening into harder steel and concrete. 100 per box. (M100BB 500 per jar)



PART NUMBER	SHANK LENGTH		R25 / RA27	SA270	XT540	COBRA	MASTER CARTON QTY
	IN.	(MM)					
M100BB	1	(25.4)	•	•	•	•	4000
SP114	1-1/4	(31.8)	•	•	•	•	1000
SP178	1-7/8	(47.6)	•	•	•	•	1000

Shank diameter = .150/.180 Head diameter = .300 M100BB shank diameter = .125/.150 with 1/2" washer

POWERPOINT TOP HAT PIN

Used for general purpose fastening to steel. Plated pin with top hat. 100 per box.



PART NUMBER	SHANK LENGTH		R25 / RA27	SA270	XT540	COBRA	MASTER CARTON QTY
	IN.	(MM)					
SP58TH	5/8"	15.8	•	•	•	•	5000

Shank diameter = .150 Head diameter = .300

TRUE EMBEDMENT PINS

The Ramset .157 True Embedment Pin is sized to provide you with True Embedment depths in track up to 14 gauge. Sized approximately 1/16" longer than nominal length to provide a True Embedment. 100 per box.



PART NUMBER	PIN LENGTH		EMBEDMENT LENGTH		R25 / RA27	VIPER	SA270	COBRA	XT540	MASTER CARTON QTY
	IN.	(MM)	IN.	(MM)						
TE12	9/16	(13.8)	1/2	(12.7)	•	•	•	•	•	5000
TE34	13/16	(20.6)	3/4	(19.1)	•	•	•	•	•	5000
TE100	1-1/16	(27)	1	(25.4)	•	•	•	•	•	5000
TE114	1-5/16	(33.3)	1-1/4	(31.8)	•	•	•	•	•	1000

Shank diameter = .157 Head diameter = .320

TRUE EMBEDMENT PINS

10-Pin Collated Stips for the Ramset RA27 with RA27MAG and other brands.



PART NUMBER	PIN LENGTH		EMBEDMENT LENGTH		Master Carton Qty
	IN.	(MM)	IN.	(MM)	
TE12X	9/16	(13.8)	1/2	(12.7)	5000
TE34X	13/16	(20.6)	3/4	(19.1)	5000
TE100X	1-1/16	(27)	1	(25.4)	5000
TE114X	1-5/16	(33.3)	1-1/4	(31.8)	5000

Shank diameter = .157 Head diameter = .320

XT540 COLLATED TRUE EMBEDMENT PINS

10-Pin Collated Stips for the XT540 with XT MAG only.



PART NUMBER	PIN LENGTH		EMBEDMENT LENGTH		MASTER CARTON QTY
	IN.	(MM)	IN.	(MM)	
TE12XT	9/16	(13.8)	1/2	(12.7)	5000
TE34XT	13/16	(20.6)	3/4	(19.1)	5000
TE100XT	1-1/16	(27)	1	(25.4)	5000
TE114XT	1-5/16	(33.3)	1-1/4	(31.8)	5000

Shank diameter = .157 Head diameter = .320 *Cannot be used in other manufacturer's magazines



SELECTION CHART

CEILING CLIP ASSEMBLIES

Designed for suspending ceilings and other overhead applications. Pin preassembled to a Zinc Plated 14 gage 45° clip. 1000 per box.

PART NUMBER	PIN LENGTH		VIPER	SA270 / RA27	COBRA	XT540	MASTER CARTON QTY
	IN.	(MM)					
SDC100	1	(25.4)	•	•	•	•	1000
SDC125*	1-1/4	(31.8)	•	•	•	•	1000

*Available in 100-Pack (P/N: SDC125C) Shank diameter = .145 Head diameter = .300 Hole Dia: .330"

PREMIUM PINS WITH CEILING CLIPS

Designed for difficult overhead applications. Pin preassembled to a zinc plated 14 gage 90° angle clip. 1000 per box

PART NUMBER	PIN LENGTH		VIPER	SA270 / RA27	COBRA	XT540	Master Carton Qty
	IN.	(MM)					
SPC78	7/8	(22.2)	•	•	•	•	1000
SPC114	1-1/4	(31.8)	•	•	•	•	1000

Shank diameter = .150 (SPC114 = .150/.180) Head diameter = .300 Hole diameter = 5/16"

FASTENER ANGLE CLIP

General purpose 3/4" wide 90° angle clip. 14 gage angle clip. 100 zinc plated clips per box.

PART NUMBER	DESCRIPTION	MASTER CARTON QTY
1202CF	Angle clip (no pin)	1000

Hole diameter: 5/16" & 13/64"

LATHER CLIP CHANNEL HANGER

PART NUMBER	DESCRIPTION	MASTER CARTON QTY
LC112	1-1/2" Lathers Clip Channel Hanger for 1/4" Plain Rod	100

INSTALLATION

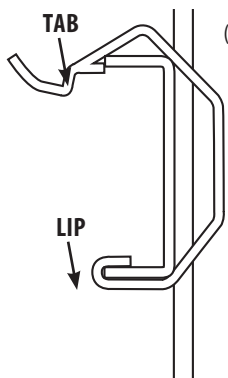

(Attached above clip)

1. Compress the clip and position on the rod at the desired location.
2. To install the channel, place the flange of the channel in the lip of the clip and rotate the channel toward the rod into position (see picture).
3. Use with cold rolled channel, with flange width 7/16" to 5/8" and hot rolled channel sizes 0.85#/ft and 0.105#/ft.
4. Static load limit, with a 3 to 1 safety factor, equals 160 lbs. Clip was tested to 480 lbs.
5. UL Tested

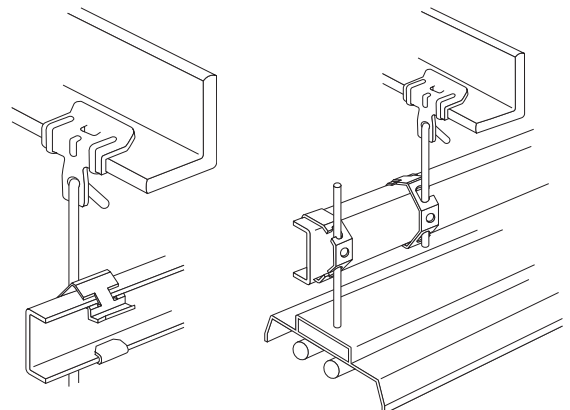

SELECTION CHART



HYBRID PIN		For general purpose attachments to concrete. PowerPoint step shank pin pre-assembled to 1/2" washer. 500 per jar.			
		PART NUMBER	DESCRIPTION	ALL POWDER TOOLS	Master Carton Quantity
		M100BB	1" PowerPoint step shank pin with 1/2" domed washer & flute	•	4000

Shank diameter = .125/.150 Head diameter = .300

ONE HOLE CONDUIT STRAP		Used to attach EMT conduit or armored cable to concrete. PowerPoint fastener pre-assembled to a 16 gage conduit strap. 100 per box.			
		PART NUMBER	DESCRIPTION	ALL POWDER TOOLS	Master Carton Quantity
		38HSSS10*	3/8" Hole strap with w/1 premium pin	• (except SA270 and Cobra)	500
		34HSSS10	3/4" Hole strap with w/1 premium pin	•	500

Shank diameter = .125/.150 Head diameter = .300 38HSSS10 = 18 gage

* Does not work with SA270 Tool

THREADED ROD HANGER		For suspended ceilings, piping, and other items using 1/4" or 3/8" threaded rod. PowerPoint fastener pre-assembled to a 16 gage threaded rod hanger. 100 per box.			
 		PART NUMBER	DESCRIPTION	ALL POWDER TOOLS	Master Carton Quantity
		14TRHSS10	1/4" Rod hanger w/1" premium pin	•	500
		38TRHSS10	3/8" Rod hanger w/1" premium pin	•	500

Shank diameter = .125/.150 Head diameter = .300

High Quality and Dependability

ITW Ramset powder loads and tools match tolerances to provide optimum power within recognized national velocity standards. Available in color-coded 10-load strips, and 100-load boxes.

Caution Always test-fasten with the lowest power level for your tool. If more power is necessary, use the next highest power level until proper level and fastening is achieved. Refer to operator's manual for more specific details. Observe all safety reminders. Tool operators must be trained and qualified as required by federal law. Failure to use properly can result in serious injury or death to users or bystanders.

Advantages Powder Guide

Power level is designated by the load level number marked on each box; also by the color of the box and each powder load. As the number increases, the power level increases.

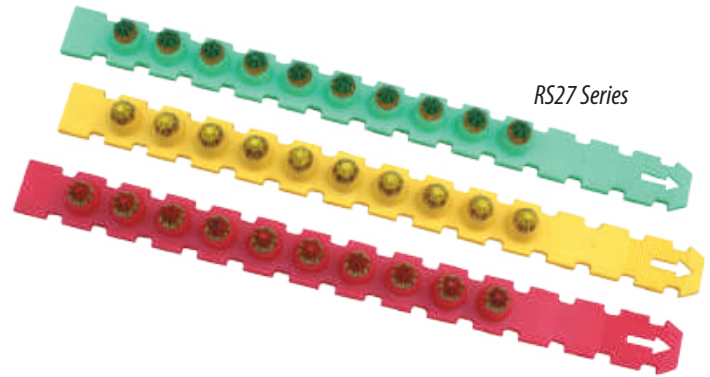
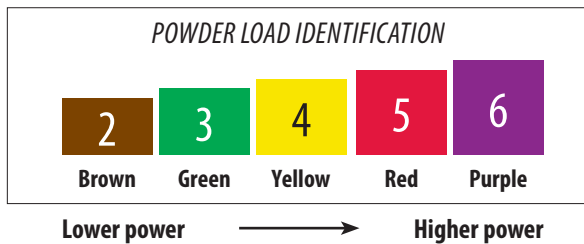

SELECTION CHART

RAMSET LOADS FOR LOW VELOCITY TOOLS						COMPATIBLE TOOLS	
PART NUMBER	POWER LEVEL	COLOR	CALIBER/TYPE	PACKAGING	Master Carton Qty	RAMSET	OTHERS
						3RS25	3
4RS25	4	Yellow	.25 Strip	10 strips/box			
5RS25	5	Red	.25 Strip	10 strips/box			
3RS27	3	Green	.27 Strip	all 10 shot strip	10,000	SA270, Cobra, Viper, Rocket and XT540	DX2, DX350, DX351, DX36M, DX460, DX5
4RS27	4	Yellow	.27 Strip	10 strips/box			
5RS27	5	Red	.27 Strip	10 strips/box			
6RS27	6	Purple	.27 Strip	10 strips/box			
							DX2, DX350, DX351, DX36M, DX451, DX460
							DX451, DX460

Performance Data/ Submittal Index

Collated Gas Fasteners in Concrete.....	38
Single Shot Gas and Powder Fasteners	39
Collated Gas Fasteners in Steel.....	39
Plywood Pin (PLY138).....	40
Gypfast Fasteners.....	42
Powder Actuated Fasteners (1500 Series).....	44
Powder Actuated Fasteners (SP Series).....	45
Powder Actuated Fasteners (TE Series).....	46
Ceiling Clips / Angle Clips.....	48



Ramset fasteners may be specified by their type or catalog number to satisfy fastening requirements.

PIN SPECIFICATIONS

- Made from AISI 1060-1065 steel. Austempered to a core hardness of 52-56 Rc
- Typical tensile strength: 270,000 psi
- Typical shear strength: 162,000 psi
- **STANDARD FINISHES**
Proprietary black
Mechanical zinc plate to a minimum thickness of .0002 meets requirements of ASTM B695—Class 5 Type I
Ramguard

APPROVALS/LISTINGS

- **ICC Evaluation Service, Inc.**
#ESR-2579 TrakFast Pins #ESR-1955 T3 Fasteners
- **City of Los Angeles**
#RR-25264 TrakFast pins #RR-25739 T3 pins



Collated Gas Fasteners in Concrete (TrakFast and T3)

PART NUMBER SERIES	SHANK DIA (INCH)	MINIMUM PENETRATION (INCH)	INSTALLED IN SOLID CONCRETE CONCRETE COMPRESSIVE STRENGTH ALLOWABLE LOAD - <i>Ultimate Load</i>					
			2,000 PSI		3,000 PSI		4,000 PSI	
			TENSION (LBS)	SHEAR (LBS)	TENSION (LBS)	SHEAR (LBS)	TENSION (LBS)	SHEAR (LBS)
FPP - Straight Shank	0.109	5/8	60 <i>434</i>	55 <i>546</i>	55 <i>453</i>	75 <i>615</i>	55 <i>472</i>	95 <i>685</i>
		3/4	60 <i>595</i>	80 <i>650</i>	55 <i>583</i>	95 <i>699</i>	55 <i>571</i>	115 <i>749</i>
FPP - Step Shank	0.104/0.118	3/4	— —	— —	— —	— —	51 <i>256</i>	83 <i>418</i>

			2,000 PSI		4,000 PSI		6,000 PSI	
			TENSION (LBS)	SHEAR (LBS)	TENSION (LBS)	SHEAR (LBS)	TENSION (LBS)	SHEAR (LBS)
T3 Straight Shank	0.125	5/8	83 <i>414</i>	109 <i>611</i>	78 <i>426</i>	80 <i>574</i>	95 <i>545</i>	128 <i>686</i>
		3/4	107 <i>541</i>	156 <i>855</i>	104 <i>593</i>	195 <i>977</i>	132 <i>658</i>	206 <i>1057</i>
T3 Step Shank	0.104/0.125	5/8	— —	— —	102 <i>525</i>	138 <i>795</i>	101 <i>511</i>	119 <i>634</i>

PART NUMBER SERIES	SHANK DIA (INCH)	MINIMUM PENETRATION (INCH)	INSTALLED IN LIGHTWEIGHT CONCRETE / DECK / BLOCK ALLOWABLE LOAD - <i>Ultimate Load</i>					
			3,000 PSI LIGHT WEIGHT CONCRETE		3,000 PSI LIGHT WEIGHT CONCRETE WITH METAL DECK - LOWER FLUTE		HOLLOW CONCRETE MASONRY UNITS (CMU ANY LOCATION)	
			TENSION (LBS)	SHEAR (LBS)	TENSION (LBS)	SHEAR (LBS)	TENSION (LBS)	SHEAR (LBS)
FPP - Straight Shank	0.109	5/8	35 <i>234</i>	55 <i>403</i>	30 <i>239</i>	205 <i>1,025</i>	35 <i>347</i>	50 <i>435</i>
		3/4	80 <i>630</i>	100 <i>756</i>	40 <i>330</i>	235 <i>1,248</i>	— —	— —
FPP - Step Shank	0.104/0.118	3/4	— —	— —	— —	— —	36 <i>184</i>	58 <i>290</i>
T3 Straight Shank	0.125	5/8	84 <i>418</i>	108 <i>540</i>	72 <i>361</i>	242 <i>1,210</i>	20 <i>243</i>	34 <i>264</i>
		3/4	108 <i>540</i>	173 <i>864</i>	93 <i>470</i>	288 <i>1,442</i>	— —	— —
T3 Step Shank	0.104/0.125	5/8	109 <i>543</i>	181 <i>904</i>	95 <i>473</i>	219 <i>1,096</i>	71 <i>357</i>	123 <i>613</i>

Note 1: ALLOWABLE loads are shown in the **LARGE BOLD** font, *Ultimate* loads are shown in *smaller italic* font. **Note 2:** Testing conducted in accordance with ICC AC70 & ASTM E1190. **Note 3:** Safety factors are based on coefficient of variation. In accordance with ICC AC70, the safety factor will be no less than 5. **Note 4:** Values shown in concrete are for the fastener only. Connected members must be investigated separately. **Note 5:** Cyclic, fatigue, shock loads, and other design criteria may require a different safety factor. **Note 6:** Job site testing may be required to determine actual job site values. **Note 7:** Minimum edge distance in concrete is 3 inches unless otherwise approved. **Note 8:** For SI: 1 lbf = 4.448 N, 1 inch = 25.4 mm, 1 ksi = 6.89MPa. **Note 9:** T3 straight shank allowable tension value in face shell of hollow CMU is 133 lbs.

Fastener Assemblies in Concrete

PART NUMBER SERIES	SHANK DIA. (INCH)	MINIMUM PENETRATION (INCH)	INSTALLED IN SOLID CONCRETE CONCRETE COMPRESSIVE STRENGTH ALLOWABLE LOAD - <i>Ultimate Load</i>						HOLLOW BLOCK Grade N, Type 1		
			4,000 PSI		6,000 PSI		3,000 PSI LIGHT WEIGHT LOWER FLUTE		FACE SHELL Min 1-1/4" face thickness		
			TENSION (LBS)	SHEAR (LBS)	TENSION (LBS)	SHEAR (LBS)	TENSION (LBS)	SHEAR (LBS)	TENSION (LBS)	SHEAR (LBS)	
GAS ASSEMBLIES	MP034TH*, M034* M100*, BR2*	5/8	78 426	80 574	62 308	— —	72 361	242 1210	133 691	— —	
		3/4	104 593	195 977	132 658	206 1057	93 470	288 1442	84 444	84 446	
	M034BB	0.104/.118	5/8	51 256	83 418	— —	— —	— —	36 184	58 290	
	34 CLIP	0.104/.125	5/8	62 310	— —	106 528	— —	44 220	— —	— —	
	38HSMP034, 12HSMP034 34HSMP034, 10HSMP034 114HSMP034, 14TRHMP034 38TRHMP034, TSHMP034 12CCMP034L, 34CCMP034L	0.104/.125	5/8	60 357	117 587	107 533	191 957	54 269	230 1150	71 357	123 613
POWDER ASSEMBLIES	M100BB, 38HSS10 12HSS10, 34HSS10 10HSS10, 14TRHSS10, 38TRHSS10	0.125/.150	3/4	107 559	213 1067	161 803	248 1240	96 478	231 1156	102 512	166 831

* ESR-1955 pin data applies. **Note 1:** ALLOWABLE loads are shown in the **LARGE BOLD** font, *Ultimate* loads are shown in *smaller italic* font. **Note 2:** Testing conducted in accordance with ICC AC70 & ASTM E1190 **Note 3:** Safety factors are based on coefficient of variation. In accordance with ICC AC70, the safety factor will be no less than 5. **Note 4:** Values shown in concrete are for fastener only. Connected members must be investigated separately. **Note 5:** Cyclic, fatigue, shock loads and other design criteria may require a different safety factor. **Note 6:** Job-site testing may be required to determine actual job site values. **Note 7:** Minimum edge distance is 3 inches unless otherwise approved. In hollow block applications, no more than one fastener per cell. **Note 8:** For SI: 1 lbf = 4.448 N, 1 inch = 25.4 mm, 1 ksi = 6.89MPa. **Note 9:** 20 ga metal deck.

Gas Fasteners in Steel

PART NUMBER	SHANK DIA (INCH)	TYPE OF SHANK	INSTALLED IN A36 STRUCTURAL STEEL STEEL THICKNESS INCHES ALLOWABLE LOAD - <i>Ultimate Load</i>					
			3/16 (.1875)		1/4 (.250)		3/8 (.375)	
			TENSION (LBS)	SHEAR (LBS)	TENSION (LBS)	SHEAR (LBS)	TENSION (LBS)	SHEAR (LBS)
FPP012	0.109	SMOOTH	195 1047	292 1570	223 1220	278 1526	181 1048 ⁷	186 1076 ⁷
FPP012S	0.104/0.118	SMOOTH	— —	— —	148 744	157 787	166 832 ⁷	157 787 ⁷
T3012	0.125	SMOOTH	63 676	162 1356	239 1285	211 1417	113 914 ⁸	197 1327 ⁸
T3012S	0.125	TAPER SMOOTH	183 958	332 1660	237 1184	356 1782	189 943 ¹⁰	392 1960 ⁷
			INSTALLED IN ASTM A 572 GRADE 50 STEEL					
T3012	0.125	SMOOTH	103 733	222 1682	147 950	119 973	147 856 ⁹	112 1014 ⁹

Note 1: ALLOWABLE loads are shown in the **LARGE BOLD** font, *Ultimate* loads are shown in *smaller italic* font. **Note 2:** Testing conducted in accordance with ICC AC70 & ASTM E1190. **Note 3:** Safety factors are based on coefficient of variation. In accordance with ICC AC70, the safety factor will be no less than 5. **Note 4:** Cyclic, fatigue, shock loads and other design criteria may require a different safety factor. **Note 5:** Job site testing may be required to determine actual job site values. **Note 6:** Values shown are for fastenings that have the entire pointed end of the fastener driven through the steel plate; except as noted below. **Note 7:** Fastener penetration is .31" minimum. **Note 8:** Fastener penetration is .29" minimum. **Note 9:** Fastener penetration is .27" minimum. **Note 10:** Fastener penetration is .25" minimum. **Note 11:** For SI: 1 lbf = 4.448 N, 1 inch = 25.4 mm, 1 ksi = 6.89MPa

PLY138 TrakFast Plywood to Steel Pin Performance Tables

ALLOWABLE SHEAR FOR WIND OR SEISMIC FORCES IN POUNDS PER FOOT FOR HORIZONTAL PLYWOOD DIAPHRAGMS WITH STEEL FRAMING

PLYWOOD GRADE	MINIMUM STEEL GAUGE ^{4, 6}	MINIMUM PANEL THICKNESS (Inches)	BLOCKED DIAPHRAGM PIN SPACING (Inches) ^{5, 6} Pin spacing at diaphragm boundaries (all cases), at continuous panel edges parallel to load (cases 3 & 4) and at the panel edges (cases 5 & 6) ALLOWABLE LOAD				UNBLOCKED DIAPHRAGM PIN SPACING (Inches) ^{5, 6} Pins spaced 6 inches max. at supported edges	
			6	4	2-1/2	2	Case 1 (no unblocked edges or continuous joints parallel to load)	All other configurations (cases 2, 3, 4, 5 & 6)
			Pin spacing at other panel edges					
			6	6	4	3		
Structural 1	20	7/16	185	280	420	475	185	140
	16	15/32	205	305	460	520	205	150
Grades other than Structural 1	20	7/16	165	250	380	430	165	125
	16	15/32	185	275	415	470	185	140

Note 1: These values are for short-time loads due to wind or earthquake and shall be reduced by 25 percent for normal loading. **Note 2:** The pin shall be long enough to penetrate through the thickness of the steel a minimum of 1/4 inch. **Note 3:** Minimum width of framing is 1-1/2 inches. **Note 4:** These shear values also apply to framing made of thicker steel. **Note 5:** Spacing of fasteners along intermediate framing members is 12 inches on center. **Note 6:** The minimum panel edge distance is 3/8 inch. **Note 7:** Values shown reflect a 5:1 safety factor. **Note 8:** For SI: 1 lbf = 4.448 N, 1 inch = 25.4 mm, 1 ksi = 6.89MPa

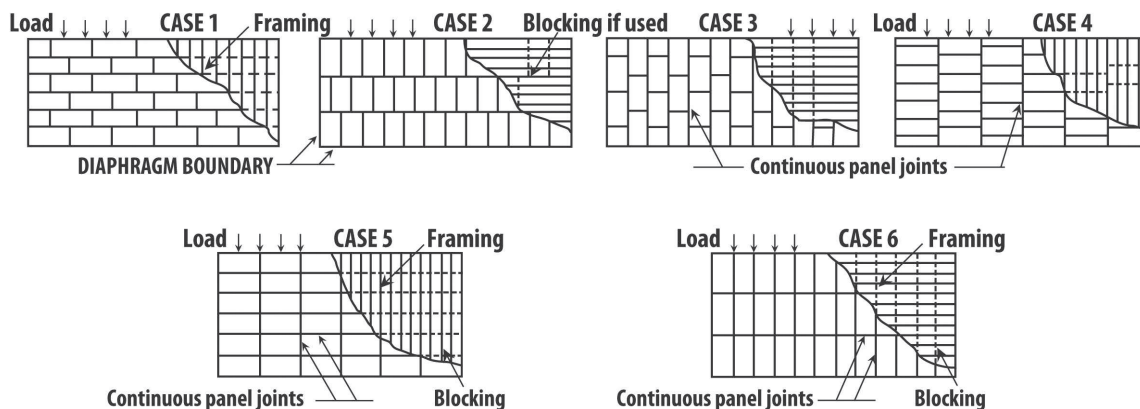

Note: Framing is permitted to be oriented in either direction for diaphragms, provided sheathing is designed for vertical loading.

ALLOWABLE WITHDRAWAL LOADS IN POUNDS PER FASTENER DUE TO WIND OR SEISMIC FORCES FOR PLYWOOD AND LUMBER ATTACHED TO STEEL FRAMING^{1, 2, 3, 4}

PIN DIAMETER (Inches)	MINIMUM STEEL THICKNESS (Gauge or Inches)	MINIMUM THICKNESS OF PLYWOOD (Inches) ALLOWABLE LOAD			
		3/8	7/16	15/32	19/32
0.100	22 / 0.030"	15	15	—	—
0.100	20 / 0.036"	20	25	25	25
0.100	18 / 0.048"	30	35	40	40
0.100	16 / 0.060"	40	45	60	60

Note 1: Plywood shall be Structural 1 rated. For other grades, values shall be reduced by 10 percent. **Note 2:** These values are for loads due to wind or earthquake and shall be reduced by 25 percent for other applications. **Note 3:** Minimum panel edge distance is 3/8 inch. **Note 4:** The pin shall be long enough to penetrate through the metal a minimum of 1/4 inch. **Note 5:** Values shown reflect a 8:1 safety factor. **Note 6:** For SI: 1 lbf = 4.448 N, 1 inch = 25.4 mm, 1 ksi = 6.89MPa

PLY138 TrakFast Plywood to Steel Pin Performance Tables

ALLOWABLE SHEAR FOR WIND FORCES IN POUNDS PER FOOT FOR PLYWOOD SHEAR WALLS WITH STEEL FRAMING

PLYWOOD GRADE	MINIMUM STEEL GAGE ⁵	MINIMUM PANEL THICKNESS (Inches)	PIN SPACING, ALL PANEL EDGES (Inches) ALLOWABLE LOAD			
			6	4	3	2
Structural 1	22	3/8 ⁶	120	180	240	305
	22	7/16 ⁶	130	195	260	330
	22	15/32	145	215	290	365
	20	3/8 ⁶	155	235	310	395
	20	7/16 ⁶	170	255	340	435
	20	15/32	205	305	410	520
Grades other than Structural 1	22	3/8 ⁶	110	165	215	275
	22	7/16 ⁶	120	175	235	300
	22	15/32	130	195	260	330
	20	3/8 ⁶	140	210	280	360
	20	7/16 ⁶	155	230	310	390
	20	15/32	185	275	370	470

Note 1: Values are for loads imposed by wind and shall be reduced by 25 percent for normal loading. **Note 2:** The pin shall be long enough to penetrate through the metal framing a minimum of 1/4 inch. **Note 3:** The minimum panel edge distance for pin placement is 3/8 inch. **Note 4:** Spacing of fasteners along intermediate framing members is 6 inches on center for 3/8 inch and 7/16 inch panels when studs are 24 inches on center and 12 inches on center when studs are 16 inches on center. For other panel thickness, spacing along intermediate framing members is 12 inches from center. **Note 5:** Framing to be spaced 24 inches on center or closer except as provided in Footnote 6. **Note 6:** The values for 3/8-inch and 7/16-inch panels may be increased by 20 percent and 10 percent, respectively, for framing spaced 16 inches on center. **Note 7:** Values shown reflect a 5:1 safety factor. **Note 8:** For SI: 1 lbf = 4.448 N, 1 inch = 25.4 mm, 1 ksi = 6.89MPa

ALLOWABLE LATERAL LOADS IN POUNDS PER FASTENER DUE TO WIND OR SEISMIC FORCES FOR STRUCTURAL¹ PLYWOOD AND LUMBER ATTACHED TO STEEL FRAMING ^{1, 2, 3, 4, 6}

PIN DIAMETER (INCHES)	MINIMUM PANEL THICKNESS (Inches)	MINIMUM THICKNESS OF PLYWOOD (Inches) ALLOWABLE LOAD					
		3/8	7/16	15/32	19/32	23/32	1-1/8
0.100	22	80	80	80	80	80	80
0.100	20	105	105	115	115	115	115
0.100	16	105	105	115	170	170	170

Note 1: Plywood shall be Structural 1 rated. For other grades, values shall be reduced by 10 percent. **Note 2:** These values are for loads due to wind or earthquake and shall be reduced by 25 percent for other applications. **Note 3:** Minimum panel edge distance for placement is 1 inch from the fastener to the sheathing edge measured in the direction of the load and 3/8 inch measured perpendicular to the direction of the load. **Note 4:** The pin shall be long enough to penetrate through the metal a minimum of 1/4 inch. **Note 5:** Values for 16 gage also apply to 14 gage. **Note 6:** The above values apply to groups of at least five fasteners. For fewer fasteners in a group, use one-half of the tabulated value. **Note 7:** Values shown reflect a 5:1 safety factor. **Note 8:** For SI: 1 lbf = 4.448 N, 1 inch = 25.4 mm, 1 ksi = 6.89MPa

GypFast fasteners for the attachment of gypsum sheathing to light gage steel framing

PIN SPECIFICATIONS

- Made from AISI 1060-1065 steel. Austempered to a core hardness of 52-56 Rc
- Typical tensile strength: 270,000 psi
- Typical shear strength: 162,000 psi
- **STANDARD FINISHES**
Mechanical zinc plate to a minimum thickness of .0002 meets requirements of ASTM B695
- Climacoat



APPROVALS/LISTINGS

- **ICC Evaluation Service, Inc.**
#ESR-2174 GypFast Gypsum Sheathing
#ER-5380 GypFast Plywood Sheathing
- **City of Los Angeles**
#RR-25638 GypFast



Allowable Negative Loads Using Ramset GypFast Fasteners

SHEATHING TYPE	MINIMUM STEEL STUD GAGE	MAXIMUM STEEL STUD SPACING (IN)	FASTENER SPACING (IN)	ALLOWABLE NEGATIVE LOAD (PSF)
1/2" GP DensGlass Gold Exterior Sheathing	20g to 12g	24	8	6
		16	8	8
5/8" GP DensGlass Gold Fireguard Type X Sheathing	20g to 12g	24	8	24
		16	8	32
1/2" USG Sheetrock Brand Sheathing	20g to 12g	24	8	12
		16	8	16
5/8" USG Sheetrock Brand Fire Code Type X Sheathing	20g to 12g	24	8	18
		16	8	24
1/2" USG Fiberock Brand Aquatough	20g to 12g	24	8	30
		16	8	40
5/8" USG Securock Glass-Mat Sheathing	18g	16	8	35
5/8" CertainTeed GlasRoc Sheathing Type X	18g	24	8	20
5/8" CertainTeed GlasRoc Sheathing Type X	16g	24	8	18
National Gypsum e2XP Extended Exposure Sheathing	18g	16	8	39

Note 1: Tested in accordance with ASTM E330. **Note 2:** Values shown reflect a 3:1 safety factor. **Note 3:** The fasteners must be driven to a depth at which the shank pierces the steel, such that the tip protrudes from the base metal a minimum of 1/2-inch. **Note 4:** Tabulated values do not allow any overdriving of fasteners into sheathing.

GypFast fasteners for the attachment of plywood sheathing to light gage steel framing

PIN SPECIFICATIONS

- Made from AISI 1060-1065 steel. Austempered to a core hardness of 52-56 Rc
- Typical tensile strength: 270,000 psi
- Typical shear strength: 162,000 psi
- **STANDARD FINISHES**
Mechanical zinc plate to a minimum thickness of .0002 meets requirements of ASTM B695
- Climacoat

APPROVALS/LISTINGS

- **ICC Evaluation Service, Inc.**
#ESR-2174 GypFast Gypsum Sheathing
#ER-5380 GypFast Plywood Sheathing
- **City of Los Angeles**
#RR-25638 GypFast

Allowable Withdrawal and Lateral Loads for a GypFast Fastener Used to Attach Structural Plywood Panels to Steel Framing Members^{1,2,3}

MINIMUM STEEL THICKNESS (gauge) ⁴	MINIMUM THICKNESS OF STRUCTURAL PANELS				MINIMUM THICKNESS OF STRUCTURAL PANELS			
	3/8 Inch	15/32 Inch	19/32 Inch	23/32 Inch	3/8 Inch	15/32 Inch	19/32 Inch	23/32 Inch
	WITHDRAWAL LOADS (POUNDS)				LATERAL LOADS (POUNDS)			
14	90	90	95	120	135	160	190	215
16	90	90	90	110	135	160	165	185
18	90	90	90	90	135	160	160	160
20	70	70	70	70	110	130	130	130
22	50	50	50	50	110	110	110	110

For SI: 1 Inch = 25.4 mm, 1 Pound = 4.448 N.

¹ Tabulated values are for loads due to wind or earthquake, and must be reduced by 25 percent for other applications.

² Tabulated values allow for no more than 20 percent of the fasteners to be overdriven more than 1/16 inch.

³ Minimum edge distance and spacing are 3/8 inch and 3 inches, respectively.

Allowable Shear for Wind Forces for Structural Plywood Shear Walls Attached to Light Gage Steel Studs with GypFast Fasteners^{1,2,3} (pounds per foot)

PANEL TYPE	MINIMUM PANEL THICKNESS	FRAMING		FASTENER SPACING ^{4,5} (INCHES ON CENTER)			
		MINIMUM GAGE ⁶	SPACING (INCHES ON CENTER)	6	4	3	2
Structural I or Rated Sheathing and Siding	3/8	22	16	180	270	360	459
	3/8		24	144	216	288	367
	15/32		16 or 24	170	255	340	433
	3/8	20	16	180	270	360	459
	3/8		24	144	216	288	367
	15/32		16 or 24	208	313	417	531
	3/8	18	16	214	321	428	546
	3/8		24	171	257	342	437
	15/32		16 or 24	253	380	506	645
	19/32	16	16 or 24	259	389	518	661
	23/32		16 or 24	259	389	518	661
	19/32		16 or 24	266	399	532	679
	23/32	14	16 or 24	296	445	593	756
	19/32		16 or 24	304	456	608	776
	23/32		16 or 24	345	517	690	879

For SI: 1 Inch = 25.4 mm, 1 Pound/Linear Foot = 0.0146 N/mm.

¹ These values are for short-term loads due to wind and must be reduced 25 percent for normal loading

² The pin must be long enough to penetrate through the metal framing a minimum of 1/4 inch

³ Tabulated values allow for a maximum of 20 percent of the fasteners to be overdriven more than 1/16 inch

⁴ All panel edges must be blocked with minimum nominal 2-inch framing. Panels are permitted to be installed either horizontally or vertically. Fasteners must be spaced a maximum of 6 inches on center along intermediate framing members for 3/8 inch-thick panels installed on framing spaced 24 inches on center, and 12 inches on center for framing 16 inches on center or thicker panels

⁵ Tabulated values are for structural plywood panels applied to one side of a wall. Values cannot be increased for panels attached to both sides of a wall

Ramset fasteners may be specified by their type or catalog number to satisfy fastening requirements.

PIN SPECIFICATIONS

- Made from AISI 1060-1065 steel. Austempered to a core hardness of 52-56 Rc
- Typical tensile strength: 270,000 psi
- Typical shear strength: 162,000 psi
- **STANDARD FINISHES**
Proprietary black
Mechanical zinc plate to a minimum thickness of .0002
meets requirements of ASTM B695—Class 5 Type 1
Ramguard

APPROVALS/LISTINGS

- **ICC Evaluation Service, Inc.**
#ESR-2690 Sill Plate
#ESR-1799 Powder Pins & Clips
- **City of Los Angeles**
#RR-22668 Powder pins



FASTENERS IN NORMAL WEIGHT CONCRETE

PART NUMBER SERIES	SHANK DIA (INCH)	MINIMUM PENETRATION (INCH)	INSTALLED IN SOLID CONCRETE CONCRETE COMPRESSIVE STRENGTH ALLOWABLE LOAD - <i>Ultimate Load</i>					
			2,000 PSI		4,000 PSI		6,000 PSI	
			TENSION (LBS)	SHEAR (LBS)	TENSION (LBS)	SHEAR (LBS)	TENSION (LBS)	SHEAR (LBS)
1500 SERIES	0.145	3/4	50 <i>655</i>	66 <i>739</i>	100 <i>511</i>	104 <i>552</i>	— —	— —
		1	152 <i>943</i>	166 <i>1229</i>	157 <i>937</i>	182 <i>1342</i>	— —	— —
		1-1/4	159 <i>1078</i>	265 <i>1665</i>	179 <i>1043</i>	267 <i>1538</i>	— —	— —
		1-1/2	154 <i>1450</i>	340 <i>2027</i>	209 <i>1357</i>	342 <i>1712</i>	— —	— —

FASTENERS IN LIGHT WEIGHT CONCRETE

PART NUMBER SERIES	SHANK DIA (INCH)	MINIMUM PENETRATION (INCH)	ALLOWABLE WORKING VALUES INSTALLED IN 3,000 PSI LIGHTWEIGHT CONCRETE ALLOWABLE LOAD - <i>Ultimate Load</i>			
			3,000 PSI LIGHTWEIGHT W/DECKING		3,000 PSI LIGHTWEIGHT	
			LOWER FLUTE TENSION	LOWER FLUTE SHEAR	TENSION	SHEAR
1500 SERIES	0.145	3/4	76 <i>395</i>	260 <i>1409</i>	167 <i>837</i>	179 <i>894</i>
		1	134 <i>668</i>	265 <i>1505</i>	200 <i>998</i>	228 <i>1141</i>
		1-1/4	157 <i>784</i>	269 <i>1344</i>	333 <i>1664</i>	400 <i>2090</i>
		1-1/2	233 <i>1163</i>	346 <i>1728</i>	391 <i>1957</i>	410 <i>2050</i>

Note 1: ALLOWABLE loads are shown in the **LARGE BOLD** font, *Ultimate* loads are shown in *smaller italic* font. **Note 2:** Testing conducted in accordance with ICC AC70 & ASTM E1190. **Note 3:** Safety factors are based on coefficient of variation. In accordance with ICC AC70, the safety factor will be no less than 5. **Note 4:** Values shown in concrete are for the fastener only. Connected members must be investigated separately. **Note 5:** Cyclic, fatigue, shock loads, and other design criteria may require a different safety factor. **Note 6:** Job site testing may be required to determine actual job site values. **Note 7:** Minimum edge distance is 3 inches unless otherwise approved. **Note 8:** For Sl: 1 lbf = 4.448 N, 1 inch = 25.4 mm, 1 ksi = 6.89MPa

FASTENERS IN STEEL

PART NUMBER SERIES	SHANK DIA (INCH)	TYPE OF SHANK	INSTALLED IN A36 STRUCTURAL STEEL-STEEL THICKNESS (INCHES) ALLOWABLE LOAD - <i>Ultimate Load</i>									
			3/16		1/4		3/8		1/2		≥ 3/4	
			TENSION (LBS)	SHEAR (LBS)	TENSION (LBS)	SHEAR (LBS)	TENSION (LBS)	SHEAR (LBS)	TENSION (LBS)	SHEAR (LBS)	TENSION (LBS)	SHEAR (LBS)
1500	0.145	SMOOTH	81 <i>790</i>	373 <i>2039</i>	181 <i>1269</i>	273 <i>1642</i>	397 <i>2169</i>	489 <i>2771</i>	243 <i>1328</i> ⁸	277 <i>1514</i> ⁸	— —	— —
		KNURLED	296 <i>1633</i>	636 <i>3516</i>	584 <i>3384</i>	659 <i>3822</i>	680 <i>3755</i>	730 <i>4030</i>	253 <i>1459</i> ⁸	293 <i>1632</i> ⁸	— —	— —

PART NUMBER SERIES	SHANK DIA (INCH)	TYPE OF SHANK	INSTALLED IN A572 GRADE 50 STRUCTURAL STEEL-STEEL THICKNESS (INCHES) ALLOWABLE LOAD - <i>Ultimate Load</i>									
			3/16		1/4		3/8		1/2		≥ 3/4	
			TENSION (LBS)	SHEAR (LBS)	TENSION (LBS)	SHEAR (LBS)	TENSION (LBS)	SHEAR (LBS)	TENSION (LBS)	SHEAR (LBS)	TENSION (LBS)	SHEAR (LBS)
1500	0.145	SMOOTH	— —	— —	— —	— —	— —	— —	— —	— —	— —	— —
		KNURLED	260 <i>1609</i>	499 <i>3182</i>	579 <i>3411</i>	725 <i>4272</i>	383 <i>2216</i> ⁷	595 <i>3431</i> ⁷	— —	— —	— —	— —

Note 1: ALLOWABLE loads are shown in the **LARGE BOLD** font, *Ultimate* loads are shown in *smaller italic* font. **Note 2:** Testing conducted in accordance with ICC AC70 & ASTM E1190. **Note 3:** Safety factors are based on coefficient of variation. In accordance with ICC AC70, the safety factor will be no less than 5. **Note 4:** Cyclic, fatigue, shock loads, and other design criteria may require a different safety factor. **Note 5:** Job site testing may be required to determine actual job site values. **Note 6:** Values shown are for fasteners that have the entire pointed end of the fastener driven through the steel plate; except as noted below. **Note 7:** Fastener penetration is 3/8" minimum. **Note 8:** Fastener penetration is 7/16" minimum. **Note 9:** Fastener penetration is 1/2" minimum. **Note 10:** For Sl: 1 lbf = 4.448 N, 1 inch = 25.4 mm, 1 ksi = 6.89MPa.

Ramset fasteners may be specified by their type or catalog number to satisfy fastening requirements.

PIN SPECIFICATIONS

- Made from AISI 1060-1065 steel. Austempered to a core hardness of 52-56 Rc
- Typical tensile strength: 270,000 psi
- Typical shear strength: 162,000 psi
- STANDARD FINISHES**
Proprietary black
Mechanical zinc plate to a minimum thickness of .0002 meets requirements of ASTM B695—Class 5 Type 1

APPROVALS/LISTINGS

- ICC Evaluation Service, Inc.**
#ESR-2690 Sill Plate
#ESR-1799 Powder Pins & Clips
- City of Los Angeles**
#RR-22668 Powder pins



FASTENERS IN NORMAL WEIGHT CONCRETE

PART NUMBER SERIES	SHANK DIA (INCH)	MINIMUM PENETRATION (INCH)	INSTALLED IN SOLID CONCRETE CONCRETE COMPRESSIVE STRENGTH ALLOWABLE LOAD - <i>Ultimate Load</i>					
			2,000 PSI		4,000 PSI		6,000 PSI	
			TENSION (LBS)	SHEAR (LBS)	TENSION (LBS)	SHEAR (LBS)	TENSION (LBS)	SHEAR (LBS)
SP SERIES	0.150	3/4	— —	— —	150 <i>803</i>	105 <i>786</i>	81 <i>493</i>	82 <i>454</i>
SP SERIES	.150/.180	1	154 <i>1043</i>	200 <i>1173</i>	243 <i>1307</i>	175 <i>1037</i>	189 <i>1125</i>	210 <i>1177</i>
		1-1/4	207 <i>1553</i>	230 <i>1636</i>	298 <i>1749</i>	218 <i>1471</i>	213 <i>1568</i>	305 <i>1780</i>
		1-1/2	— —	— —	384 <i>2126</i>	391 <i>1957</i>	239 <i>1886</i>	594 <i>2968</i>

FASTENERS IN LIGHT WEIGHT CONCRETE

PART NUMBER SERIES	SHANK DIA (INCH)	MINIMUM PENETRATION (INCH)	ALLOWABLE WORKING VALUES INSTALLED IN 3,000 PSI LIGHTWEIGHT CONCRETE ALLOWABLE LOAD - <i>Ultimate Load</i>			
			3,000 PSI LIGHTWEIGHT W/DECKING		3,000 PSI LIGHTWEIGHT	
			LOWER FLUTE TENSION	LOWER FLUTE SHEAR	TENSION	SHEAR
SP SERIES	.150/.180	1	119 <i>593</i>	336 <i>1679</i>	226 <i>1129</i>	250 <i>1249</i>
		1-1/4	175 <i>957</i>	372 <i>1860</i>	329 <i>1644</i>	377 <i>1885</i>
		1-1/2	179 <i>1055</i>	426 <i>2128</i>	406 <i>2030</i>	380 <i>1900</i>

Note 1: ALLOWABLE loads are shown in the **LARGE BOLD** font, *Ultimate* loads are shown in *smaller italic* font. **Note 2:** Testing conducted in accordance with ICC AC70 & ASTM E1190. **Note 3:** Safety factors are based on coefficient of variation. In accordance with ICC AC70, the safety factor will be no less than 5. **Note 4:** Values shown in concrete are for the fastener only. Connected members must be investigated separately. **Note 5:** Cyclic, fatigue, shock loads, and other design criteria may require a different safety factor. **Note 6:** Job site testing may be required to determine actual job site values. **Note 7:** For SI: 1 lbf = 4.448 N, 1 inch = 25.4 mm, 1 ksi = 6.89MPa

FASTENERS IN STEEL

PART NUMBER SERIES	SHANK DIA (INCH)	TYPE OF SHANK	INSTALLED IN A36 STRUCTURAL STEEL-STEEL THICKNESS (INCHES) ALLOWABLE LOAD - <i>Ultimate Load</i>									
			3/16		1/4		3/8		1/2		≥ 3/4	
			TENSION (LBS)	SHEAR (LBS)	TENSION (LBS)	SHEAR (LBS)	TENSION (LBS)	SHEAR (LBS)	TENSION (LBS)	SHEAR (LBS)	TENSION (LBS)	SHEAR (LBS)
SP SERIES	0.150	SMOOTH	385 <i>2107</i>	662 <i>3618</i>	445 <i>2549</i>	477 <i>2736</i>	393 <i>2145</i>	574 <i>3137</i>	948 <i>5180</i>	597 <i>3500</i>	234 <i>1244</i> ⁸	356 <i>1895</i> ⁸

PART NUMBER SERIES	SHANK DIA (INCH)	TYPE OF SHANK	INSTALLED IN A572 GRADE 50 STRUCTURAL STEEL-STEEL THICKNESS (INCHES) ALLOWABLE LOAD - <i>Ultimate Load</i>									
			3/16		1/4		3/8		1/2		≥ 3/4	
			TENSION (LBS)	SHEAR (LBS)	TENSION (LBS)	SHEAR (LBS)	TENSION (LBS)	SHEAR (LBS)	TENSION (LBS)	SHEAR (LBS)	TENSION (LBS)	SHEAR (LBS)
SP SERIES	0.150	SMOOTH	356 <i>2123</i>	569 <i>3394</i>	554 <i>3232</i>	637 <i>3710</i>	604 <i>3447</i>	602 <i>3437</i>	814 <i>4473</i> ⁹	820 <i>4503</i> ⁹	243 <i>1362</i> ⁸	381 <i>2141</i> ⁸

Note 1: ALLOWABLE loads are shown in the **LARGE BOLD** font, *Ultimate* loads are shown in *smaller italic* font. **Note 2:** Testing conducted in accordance with ICC AC70 & ASTM E1190. **Note 3:** Safety factors are based on coefficient of variation. In accordance with ICC AC70, the safety factor will be no less than 5. **Note 4:** Cyclic, fatigue, shock loads, and other design criteria may require a different safety factor. **Note 5:** Job site testing may be required to determine actual job site values. **Note 6:** Values shown are for fastenings that have the entire pointed end of the fastener driven through the steel plate; except as noted below. **Note 7:** Fastener penetration is 3/8" minimum. **Note 8:** Fastener penetration is 7/16" minimum. **Note 9:** Fastener penetration is 1/2" minimum **Note 10:** For SI: 1 lbf = 4.448 N, 1 inch = 25.4 mm, 1 ksi = 6.89MPa.

Ramset fasteners may be specified by their type or catalog number to satisfy fastening requirements.

PIN SPECIFICATIONS

- Made from AISI 1060-1065 steel. Austempered to a core hardness of 52-56 Rc
- Typical tensile strength: 270,000 psi
- Typical shear strength: 162,000 psi
- STANDARD FINISHES**
Mechanical zinc plate to a minimum thickness of .0002 meets requirements of ASTM B695—Class 5 Type 1

APPROVALS/LISTINGS

- ICC Evaluation Service, Inc.**
#ESR-2690 Sill Plate
#ESR-1799 Powder Pins & Clips
- City of Los Angeles**
#RR-22668 Powder pins



FASTENERS IN NORMAL WEIGHT CONCRETE

PART NUMBER SERIES	SHANK DIA (INCH)	MINIMUM PENETRATION (INCH)	INSTALLED IN SOLID CONCRETE CONCRETE COMPRESSIVE STRENGTH ALLOWABLE LOAD - <i>Ultimate Load</i>					
			2000 PSI		4000 PSI		6000 PSI	
			TENSION (LBS)	SHEAR (LBS)	TENSION (LBS)	SHEAR (LBS)	TENSION (LBS)	SHEAR (LBS)
TE	0.157	3/4	71 627	116 713	71 559	116 685	109 753	117 712
		1	197 986	216 1463	258 1390	216 1421	214 1313	383 1998
		1-1/4	264 1399	283 1626	377 1886	317 1846	415 2074	349 1858
		1-1/2	212 1453	297 1719	242 1211	479 2393		

FASTENERS IN LIGHT WEIGHT CONCRETE

PART NUMBER SERIES	SHANK DIA (INCH)	EMBED (INCHES)	3000 PSI LIGHT WEIGHT CONCRETE	
			TENSION (LBS)	SHEAR (LBS)
TE SERIES	0.157	3/4	152 1070	159 998
		1	325 1625	347 1737
		1-1/4	358 1790	437 2239
		1-1/2	466 2332	478 2392

Note 1: ALLOWABLE loads are shown in the **LARGE BOLD** font, *Ultimate* loads are shown in *smaller italic* font. **Note 2:** Testing conducted in accordance with ICC AC70 & ASTM E1190. **Note 3:** Safety factors are based on coefficient of variation. In accordance with ICC AC70, the safety factor will be no less than 5. **Note 4:** Values shown in concrete are for the fastener only. Connected members must be investigated separately. **Note 5:** Cyclic, fatigue, shock loads, and other design criteria may require a different safety factor. **Note 6:** Job site testing may be required to determine actual job site values. **Note 7:** Minimum edge distance is 3 inches unless otherwise approved. **Note 8:** For Sl: 1 lbf = 4.448 N, 1 inch = 25.4 mm, 1 ksi = 6.89MPa

INSTALLED IN A36 STRUCTURAL STEEL (INCHES)

PART NUMBER SERIES	SHANK DIA (INCH)	SHANK TYPE	3/16		1/4		3/8		1/2		≥3/4	
			TENSION	SHEAR	TENSION	SHEAR	TENSION	SHEAR	TENSION	SHEAR	TENSION	SHEAR
TE SERIES	0.157	KNURLED	323 1739	606 3257	562 3022	673 3621	934 5095	820 4473	603 3286	766 4178	343 ⁵	496 ⁶

INSTALLED IN A572-GR50 STRUCTURAL STEEL (INCHES)

PART NUMBER SERIES	SHANK DIA (INCH)	SHANK TYPE	3/16		1/4		3/8		1/2		≥3/4	
			TENSION	SHEAR	TENSION	SHEAR	TENSION	SHEAR	TENSION	SHEAR	TENSION	SHEAR
TE SERIES	0.157	KNURLED	442 2400	676 3674	630 3747	662 3942	760 4421	725 4218	582 ⁵ 3118	532 ⁵ 2851	311 ⁵	469 ⁵

Notes:

- Fasteners tested to ASTM E1190 & ICC-ES AC70
- Allowable loads are shown in **bold font**, ultimate loads are shown in smaller, *italic font*
- Allowable loads and safety factors are based on coefficient of variation in accordance with ICC AC70, the safety factor will be no less than 5
- Values shown for steel base materials have the pointed end of the fastener driven through the steel plate
- Fastener penetration into steel must be minimum 7/16 inch
- Fastener penetration into steel must be minimum 3/8 inch
- For Sl: 1 lbf = 4.448 N, 1 inch = 25.4 mm, 1 ksi = 6.89MPa



Ramset fasteners may be specified by their type or catalog number to satisfy fastening requirements.

PIN SPECIFICATIONS

- Made from AISI 1060-1065 steel. Austempered to a core hardness of 52-56 Rc
- Typical tensile strength: 270,000 psi
- Typical shear strength: 162,000 psi
- STANDARD FINISHES**
Mechanical zinc plate to a minimum thickness of .0002 meets requirements of ASTM B695—Class 5 Type 1

APPROVALS/LISTINGS

- ICC Evaluation Service, Inc.**
#ESR-2690 Sill Plate
#ESR-1799 Powder Pins & Clips
- City of Los Angeles**
#RR-22668 Powder pins



FASTENERS INSTALLED THROUGH METAL DECK INTO MINIMUM 3,000 PSI LIGHTWEIGHT CONCRETE

PART NUMBER SERIES	SHANK DIA (INCH)	SHANK DESCRIPTION	MINIMUM PENETRATION (INCH)	3-INCH DEEP W TYPE STEEL DECK		1 1/2 INCH DEEP B TYPE STEEL DECK			
						UPPER FLUTE		LOWER FLUTE	
				TENSION (LBS)	SHEAR (LBS)	TENSION (LBS)	SHEAR (LBS)	TENSION (LBS)	SHEAR (LBS)
TE	0.157	Smooth-tapered	3/4	106 529	265 1326	131 656	261 1305	154 769	307 1537
			1	152 761	327 1634	156 782	273 1365	138 692	265 1326
			1-1/4	164 821	330 1650	— —	— —	— —	— —
			1-1/2	238 1191	448 2240	— —	— —	— —	— —

Note 1: ALLOWABLE loads are shown in the **LARGE BOLD** font, *Ultimate* loads are shown in *smaller italic* font. **Note 2:** Testing conducted in accordance with ICC AC70 & ASTM E1190. **Note 3:** Safety factors are based on coefficient of variation. In accordance with ICC AC70, the safety factor will be no less than 5. **Note 4:** Values shown in concrete are for the fastener only. Connected members must be investigated separately. **Note 5:** Cyclic, fatigue, shock loads, and other design criteria may require a different safety factor. **Note 6:** Job site testing may be required to determine actual job site values. **Note 7:** Minimum edge distance is 3 inches unless otherwise approved. **Note 8:** For Sl: 1 lbf = 4.448 N, 1 inch = 25.4 mm, 1 ksi = 6.89MPa

FASTENERS DRIVEN INTO CONCRETE MASONRY UNITS (CMU BLOCK)

PART NUMBER SERIES	SHANK DIA (INCH)	EMBED	HOLLOW UNGROUTED CMU				GROUT-FILLED CMU					
			FACE SHELL		MORTAR JOINT		FACE SHELL		MORTAR JOINT		TOP OF GROUTED CELL	
			TENSION	SHEAR	TENSION	SHEAR	TENSION	SHEAR	TENSION	SHEAR	TENSION	SHEAR
TE	0.157	1	33 329	100 693	42 443	68 746	139 875	145 936	91 950	127 1328	165 851	171 922

For Sl: 1 Inch = 25.4 mm, 1 lbf = 4.448 N.

Fasteners must be installed a minimum of 5.1 inches from the end of the wall.

Fasteners must be installed at the center of the CMU cell. No more than one fastener may be installed in an individual CMU cell

Applicable to fasteners installed in the horizontal mortar joint (bed joint). Minimum fastener spacing must be 5.1 inches

Allowable shear load value applies to load applied perpendicular to the mortar joint

Fastener must be installed vertically at the top, center of grouted cell

Shear load can be in any direction perpendicular to the axis of the fastener

TE Embedment depth is easily identifiable by head stamps.





Angle Clip in Concrete

PART NUMBER SERIES	SHANK DIAMETER (INCH)	MINIMUM PENETRATION (INCH)	INSTALLED IN NORMAL WEIGHT CONCRETE CONCRETE COMPRESSIVE STRENGTH ALLOWABLE LOAD - <i>Ultimate Load</i>					
			4000 PSI			6000 PSI		
			TENSION (LBS)	SHEAR (LBS)	OBLIQUE (LBS)	TENSION (LBS)	SHEAR (LBS)	OBLIQUE (LBS)
SDC100 SDC125	0.145	7/8	115 <i>575</i>	120 <i>1014</i>	145 <i>726</i>	— —	— —	— —
SDC125	0.145	1-1/8	130 <i>744</i>	167 <i>1090</i>	205 <i>1032</i>	— —	— —	— —
SPC78	0.150	3/4	155 <i>897</i>	188 <i>1050</i>	— —	150 <i>788</i>	153 <i>949</i>	140 <i>769</i>
SPC114	.150/.180	1-1/8	127 <i>811</i>	226 <i>1130</i>	181 <i>904</i>	169 <i>853</i>	300 <i>1500</i>	223 <i>1114</i>

PART NUMBER SERIES	SHANK DIAMETER (INCH)	MINIMUM PENETRATION (INCH)	ALLOWABLE WORKING VALUES INSTALLED IN 3000 PSI LIGHTWEIGHT CONCRETE ALLOWABLE LOAD - <i>Ultimate Load</i>				
			3000 PSI LIGHTWEIGHT WITH METAL DECKING				
			LOWER FLUTE TENSION (LBS)	LOWER FLUTE SHEAR (LBS)	LOWER FLUTE OBLIQUE (LBS)	UPPER FLUTE TENSION (LBS)	UPPER FLUTE SHEAR (LBS)
SDC100 SDC125	0.145	7/8	67 <i>335</i>	237 <i>1186</i>	90 <i>448</i>	104 <i>571</i>	310 <i>1678</i>
SDC125	0.145	1-1/8	94 <i>471</i>	276 <i>1378</i>	119 <i>596</i>	106 <i>528</i>	319 <i>1597</i>
SPC78	0.150	3/4	59 <i>293</i>	202 <i>1109</i>	65 <i>323</i>	84 <i>419</i>	324 <i>1622</i>
SPC114	.150/.180	1-1/8	157 <i>786</i>	272 <i>1358</i>	153 <i>766</i>	180 <i>899</i>	334 <i>1673</i>

Note 1: ALLOWABLE loads are shown in the **LARGE BOLD** font, *Ultimate* loads are shown in *smaller italic* font. **Note 2:** Testing conducted in accordance with ICC AC70 & ASTM E1190. **Note 3:** Safety factors are based on coefficient of variation. In accordance with ICC AC70, the safety factor will be no less than 5. **Note 4:** Values shown in concrete are for the clip assembly only. Connected members must be investigated separately. **Note 5:** Cyclic, fatigue, shock loads, and other design criteria may require a different safety factor. **Note 6:** Job site testing may be required to determine actual job site values. **Note 7:** Minimum edge distance is 3 inches unless otherwise approved. **Note 8:** For Sl: 1 lbf = 4.448 N, 1 inch = 25.4 mm, 1 ksi = 6.89MPa. **Note 9:** Metal deck is 20g. Ceiling clips = ASTM A653

FASTENERS IN STEEL / LIGHTWEIGHT CONCRETE / ANGLE CLIP CONCRETE



Ramset[®]
DRIVING JOBSITE SPEED

NATIONAL HEADQUARTERS

ITW COMMERCIAL CONSTRUCTION,
NORTH AMERICA
155 HARLEM AVE
GLENVIEW, IL 60025
PHONE: 800-848-5611
FAX: 630-893-1270

TECHNICAL SUPPORT

PHONE: 800-848-5611
HOURS: 8:30 A.M. - 5:00 P.M. (CST, M-F)
EMAIL: TECHSUPPORT@ITWCCNA.COM

WILL CALL/DISTRIBUTION

2501 GALVIN DR
ELGIN, IL 60123
PHONE: 800-848-5611

CUSTOMER SERVICE

PHONE: 800-848-5611
HOURS: 7:30 A.M. - 5:00 P.M. (CST, M-F)
EMAIL: ORDERS@ITWCCNA.COM

www.ramset.com