

 **Lincoln**[®] PRODUCTS

FAUCET REPAIR

Section 5

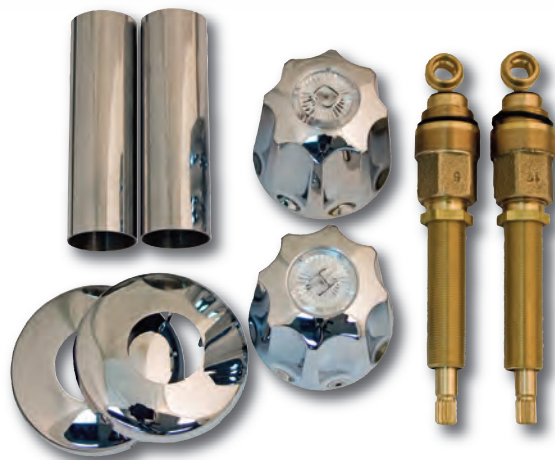

Faucet Renovation Kits

These kits contain the parts needed to repair and beautify your old worn out tub and shower valves. Each kit contains new operating components along with the trim and handles needed to revitalize your classic valve. After installing one of these professional grade renovation kits, your tub and shower valve will work and look like new.

Kit# 111813▲



FITS AMERICAN BRASS

- 2-Handle Valve
- Contains All Pictured Parts

Kit# 111814▲



FITS AMERICAN BRASS

- 3-Handle Valve
- Contains All Pictured Parts

Kit# 111816▲



FITS AMERICAN STANDARD Aquaseal

- 2-Handle Valve
- Contains All Pictured Parts

Individual Stem Numbers:

Lincoln: 100420 - hot
100470 - cold

Genuine:
130420_072950-1700AP - hot
130470_072951-1700AP - cold

Kit# 111881▲
Kit# 101881▲ Clamshell



FITS AMERICAN STANDARD Aquaseal

- 3-Handle Valve
- Contains All Pictured Parts

Individual Stem Numbers:

Lincoln: 100420 - hot
100470 - cold

Genuine:
130420_072950-1700AP - hot
130470_072951-1700AP - cold

Kit# 111834▲



FITS AMERICAN STANDARD Aquaseal

- 2-Handle Valve
- Contains All Pictured Parts

Individual Stem Numbers:

Lincoln: 100420 - hot
100470 - cold

Genuine:
130420_072950-1700AP - hot
130470_072951-1700AP - cold

Kit# 111835▲



FITS AMERICAN STANDARD Aquaseal

- 3-Handle Valve
- Contains All Pictured Parts

Individual Stem Numbers:

Lincoln: 100420 - hot
100470 - cold

Genuine:
130420_072950-1700AP - hot
130470_072951-1700AP - cold

Kit# 111817▲



FITS AMERICAN STANDARD Cadet

- 2-Handle Valve
- Contains All Pictured Parts

Individual Stem Numbers:

Lincoln: 101274 - hot/cold

Kit# 111818▲



FITS AMERICAN STANDARD Cadet

- 3-Handle Valve
- Contains All Pictured Parts

Individual Stem Numbers:

Lincoln: 101274 - hot/cold



Faucet Renovation Kits

These kits contain the parts needed to repair and beautify your old worn out tub and shower valves. Each kit contains new operating components along with the trim and handles needed to revitalize your classic valve. After installing one of these professional grade renovation kits, your tub and shower valve will work and look like new.

Kit# 111819▲



FITS AMERICAN STANDARD Nu-Renu

- 2-Handle Valve
- Contains All Pictured Parts

Individual Stem Numbers:

Lincoln: 100418 - hot
100468 - cold

Genuine:
130418_006079-0040AP - hot
130418_006080-0040AP - cold

Kit# 111824▲



FITS AMERICAN STANDARD Nu-Renu

- 3-Handle Valve
- Contains All Pictured Parts

Individual Stem Numbers:

Lincoln: 100418 - hot
100468 - cold

Genuine:
130418_006079-0040AP - hot
130418_006080-0040AP - cold

Kit# 111826▲



FITS AMERICAN STANDARD Renu

- 2-Handle Valve
- Canopy Bonnet Nut Style
- Contains All Pictured Parts

Individual Stem Numbers:

Genuine:
132433_18293-0200AP - hot/cold

Kit# 111827▲



FITS AMERICAN STANDARD Renu

- 3-Handle Valve
- Canopy Bonnet Nut Style
- Contains All Pictured Parts

Individual Stem Numbers:

Genuine:
132433_18293-0200AP - hot/cold

Kit# 111830▲



FITS AMERICAN STANDARD Renu

- 3-Handle Valve
- Flat Bonnet Nut Style
- Contains All Pictured Parts

Individual Stem Numbers:

Genuine:
132433_18293-0200AP - hot/cold

Kit# 111828▲



FITS AMERICAN STANDARD Tract Line

- 2-Handle Valve
- Contains All Pictured Parts

Individual Stem Numbers:

Genuine:
132333_009806-0020AP - hot/cold

Kit# 111829▲



FITS AMERICAN STANDARD Tract Line

- 3-Handle Valve
- Contains All Pictured Parts

Individual Stem Numbers:

Genuine:
132333_009806-0020AP - hot/cold
132426_009803-0020AP - Diverter

Kit# 111831▲



FITS AMERICAN STANDARD Colony

- 3-Handle Valve
- Long Sleeve
- Contains All Pictured Parts

Individual Stem Numbers:

Lincoln: 102317 - hot/cold



Faucet Renovation Kits

These kits contain the parts needed to repair and beautify your old worn out tub and shower valves. Each kit contains new operating components along with the trim and handles needed to revitalize your classic valve. After installing one of these professional grade renovation kits, your tub and shower valve will work and look like new.

Kit# 111832▲



FITS AMERICAN STANDARD Colony

- 2-Handle Valve
- Short Sleeve
- Contains All Pictured Parts

Individual Stem Numbers:
Lincoln: 102324 - hot/cold

Kit# 111833▲



FITS AMERICAN STANDARD Colony

- 3-Handle Valve
- Short Sleeve
- Contains All Pictured Parts

Individual Stem Numbers:
Lincoln: 102324 - hot/cold
102434 - Diverter

Kit# 111815▲

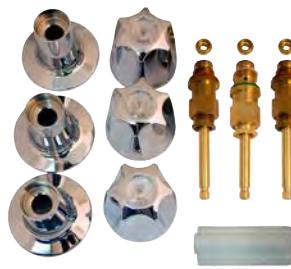

FITS ARROWHEAD

- 3-Handle Valve
- Contains All Pictured Parts

Kit# 111836▲



FITS BRIGGS

- 2-Handle Valve
- Contains All Pictured Parts

Kit# 111837▲



FITS BRIGGS

- 3-Handle Valve
- Contains All Pictured Parts

Kit# 111838▲



FITS BRIGGS Trim Line

- 3-Handle Valve
- Contains All Pictured Parts

Kit# 111839▲



FITS BRIGGS

- 3-Handle Valve
- Contains All Pictured Parts

Kit# 111840▲



FITS CENTRAL BRASS

- 2-Handle Valve
- Contains All Pictured Parts



Faucet Renovation Kits

These kits contain the parts needed to repair and beautify your old worn out tub and shower valves. Each kit contains new operating components along with the trim and handles needed to revitalize your classic valve. After installing one of these professional grade renovation kits, your tub and shower valve will work and look like new.

Kit# 111841▲



FITS CENTRAL BRASS

- 3-Handle Valve
- Contains All Pictured Parts

Kit# 111842▲



FITS CENTRAL BRASS

- 2-Handle Valve
- Contains All Pictured Parts

Individual Stem Numbers:
Lincoln: 121218 - hot/cold

Kit# 111843▲



FITS CENTRAL BRASS

- 3-Handle Valve
- Contains All Pictured Parts

Individual Stem Numbers:
Lincoln: 121218 - hot/cold

Kit# 111844▲



FITS CRANE/REPCAL

- 2-Handle Valve
- Contains All Pictured Parts

Kit# 111845▲



FITS CRANE/REPCAL

- 3-Handle Valve
- Contains All Pictured Parts

Kit# 111846▲



FITS CRANE/REPCAL

- 2-Handle Valve
- Contains All Pictured Parts

Individual Stem Numbers:
Lincoln: 102362 - hot/cold

Kit# 111847▲



FITS CRANE/REPCAL

- 2-Handle Valve
- Contains All Pictured Parts

Kit# 111848▲



FITS CRANE/REPCAL

- 2-Handle Valve
- Contains All Pictured Parts



SECTION 5 • PAGE 4

Faucet Renovation Kits

These kits contain the parts needed to repair and beautify your old worn out tub and shower valves. Each kit contains new operating components along with the trim and handles needed to revitalize your classic valve. After installing one of these professional grade renovation kits, your tub and shower valve will work and look like new.

Kit# 111849▲



FITS CRANE/REPCAL

- 3-Handle Valve
- Contains All Pictured Parts

Kit# 111850▲



FITS ELJER Luster Line

- 2-Handle Valve
- Contains All Pictured Parts

Individual Stem Numbers:
Lincoln: 102332 - hot/cold

Kit# 111851▲

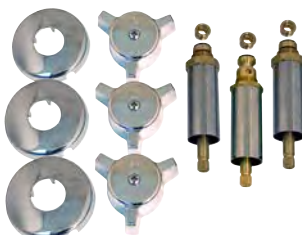

FITS ELJER Luster Line

- 3-Handle Valve
- Contains All Pictured Parts

Individual Stem Numbers:
Lincoln: 102332 - hot/cold

Kit# 111852▲



FITS ELJER

- 3-Handle Valve
- Contains All Pictured Parts

Individual Stem Numbers:
Lincoln: 121202 - hot
121252 - cold

Kit# 111853▲



FITS GERBER

- 2-Handle Valve
- Long Broach Handle
- Contains All Pictured Parts

Individual Stem Numbers:
Lincoln: 102435 - hot/cold

Kit# 111879▲



FITS GERBER

- 3-Handle Valve
- Long Broach Handle
- Contains All Pictured Parts

Individual Stem Numbers:
Lincoln: 102435 - hot/cold
102436 - diverter

Kit# 111854▲



FITS GERBER

- 2-Handle Valve
- Long Broach Handle
- Contains All Pictured Parts

Individual Stem Numbers:
Lincoln: 102435 - hot/cold

Kit# 111855▲



FITS GERBER

- 3-Handle Valve
- Long Broach Handle
- Contains All Pictured Parts

Individual Stem Numbers:
Lincoln: 102435 - hot/cold
102436 - diverter



Faucet Renovation Kits

These kits contain the parts needed to repair and beautify your old worn out tub and shower valves. Each kit contains new operating components along with the trim and handles needed to revitalize your classic valve. After installing one of these professional grade renovation kits, your tub and shower valve will work and look like new.

Kit# 111856▲



FITS HARCRAFT

- 3-Handle Valve
- Contains All Pictured Parts

Individual Stem Numbers:
Lincoln: 102414 - hot/cold

Kit# 111857▲



FITS HARCRAFT

- 2-Handle Valve
- Contains All Pictured Parts

Kit# 111858▲



FITS HARCRAFT

- 3-Handle Valve
- Contains All Pictured Parts

Kit# 111859▲



FITS HARCRAFT

- 2-Handle Valve
- Contains All Pictured Parts

Individual Stem Numbers:
Lincoln: 102414 - hot/cold

Kit# 111860▲



FITS HARCRAFT

- 3-Handle Valve
- Contains All Pictured Parts

Individual Stem Numbers:
Lincoln: 102414 - hot/cold

Kit# 111861▲



FITS INDIANA

- 2-Handle Valve
- Contains All Pictured Parts

Kit# 111862▲



FITS INDIANA

- 3-Handle Valve
- Contains All Pictured Parts

Kit# 111863▲



FITS INDIANA

- 3-Handle Valve
- Contains All Pictured Parts



Faucet Renovation Kits

These kits contain the parts needed to repair and beautify your old worn out tub and shower valves. Each kit contains new operating components along with the trim and handles needed to revitalize your classic valve. After installing one of these professional grade renovation kits, your tub and shower valve will work and look like new.



Kit# 111864▲

FITS KOHLER Trend

- 2-Handle Valve
- Contains All Pictured Parts

Individual Stem Numbers:
Lincoln: 102344 - hot/cold



Kit# 111865▲

FITS KOHLER Trend

- 3-Handle Valve
- Contains All Pictured Parts

Individual Stem Numbers:
Lincoln: 102344 - hot/cold



Kit# 111873▲

FITS KOHLER Trend

- 3-Handle Valve
- Long Diverter
- Contains All Pictured Parts

Individual Stem Numbers:
Lincoln: 102344 - hot/cold



Kit# 111866▲

FITS KOHLER

- 2-Handle Valve
- Contains All Pictured Parts



Kit# 111867▲

FITS KOHLER

- 3-Handle Valve
- Contains All Pictured Parts



Kit# 111868▲

FITS KOHLER

- 2-Handle Valve
- Contains All Pictured Parts



Kit# 111869▲

FITS KOHLER

- 3-Handle Valve
- Contains All Pictured Parts



Kit# 111870▲

FITS KOHLER Valvet

- 2-Handle Valve
- Contains All Pictured Parts

Individual Stem Numbers:
Lincoln: 100415 - hot
100465 - cold
Genuine:
131230_GP30002 - hot
131280_GP30004 - cold



Faucet Renovation Kits

These kits contain the parts needed to repair and beautify your old worn out tub and shower valves. Each kit contains new operating components along with the trim and handles needed to revitalize your classic valve. After installing one of these professional grade renovation kits, your tub and shower valve will work and look like new.

Kit# 111872▲



**FITS KOHLER
Valvet**

- 3-Handle Valve
- Contains All Pictured Parts

Individual Stem Numbers:
Lincoln: 100415 - hot
100465 - cold
Genuine:
131230_GP30002 - hot
131280_GP30004 - cold

Kit# 111825▲



**FITS PFISTER
Verve**

- 2-Handle Valve
- Contains All Pictured Parts

Individual Stem Numbers:
Lincoln: 102461 - hot/cold
Genuine:
132461_S10-375 - hot/cold

Kit# 111821▲ Boxed
Kit# 101821▲ Clamshell
Kit# 131820▲ S10-230
Clamshell (Genuine)



**FITS PFISTER
Verve**

- 3-Handle Valve
- Contains All Pictured Parts

Individual Stem Numbers:
Lincoln: 102461 - hot/cold
102462 - diverter
Genuine:
132461_S10-375 - hot/cold
132462_S10-385 - diverter

Kit# 111874▲



**FITS PFISTER
Verve**

- 2-Handle Valve,
With Integral Stops
- Contains All Pictured Parts

Individual Stem Numbers:
Lincoln: 102461 - hot/cold
Genuine:
132461_S10-375 - hot/cold

Kit# 111876▲



**FITS PFISTER
Verve**

- 3-Handle Valve,
with Integral Stops
- Contains All Pictured Parts

Individual Stem Numbers:
Lincoln: 102461 - hot/cold
102462 - diverter
Genuine:
132461_S10-375 - hot/cold
132462_S10-385 - diverter

Kit# 101823▲ Clamshell
Kit# 131822▲ S10-220
Clamshell (Genuine)



**FITS PFISTER
Windsor**

- 3-Valve
- Contains All Pictured Parts

Individual Stem Numbers:
Lincoln: 102461 - hot/cold
102462 - diverter
Genuine:
132461_S10-375 - hot/cold
132462_S10-385 - diverter

Kit# 111889▲



FITS SAVOY

- 3-Handle Valve
- Contains All Pictured Parts

Kit# 111890▲



FITS SAVOY

- 2-Handle Valve
- Contains All Pictured Parts

Faucet Renovation Kits

These kits contain the parts needed to repair and beautify your old worn out tub and shower valves. Each kit contains new operating components along with the trim and handles needed to revitalize your classic valve. After installing one of these professional grade renovation kits, your tub and shower valve will work and look like new.



Kit# 111891▲

FITS SAVOY

- 2-Handle Valve
- Contains All Pictured Parts



Kit# 111875▲

FITS SAYCO

- 3-Handle Valve
- Contains All Pictured Parts

Individual Stem Numbers:
Lincoln: 102326 - hot/cold
102417 - diverter



Kit# 111877▲

FITS SAYCO

- 2-Handle Valve
- Contains All Pictured Parts

Individual Stem Numbers:
Lincoln: 102326 - hot/cold



Kit# 111887▲

FITS SPEAKMAN Diamond

- 3-Handle Valve
- Contains All Pictured Parts



Kit# 111888▲

FITS SPEAKMAN LIN111888

- 2-Handle Valve
- Contains All Pictured Parts



Kit# 111871▲ Boxed
Kit# 101871▲ Clamshell

FITS STERLING LIN111871

- 3-Handle Valve
- Contains All Pictured Parts

Individual Stem Numbers:
Lincoln: 102308 - hot/cold
102310 - diverter



Kit# 111878▲

FITS STERLING

- 2-Handle Valve
- Contains All Pictured Parts

Individual Stem Numbers:
Lincoln: 102308 - hot/cold



Kit# 111880▲

FITS STERLING

- 2-Handle Valve
- Contains All Pictured Parts

Individual Stem Numbers:
Lincoln: 102323 - hot/cold



Faucet Renovation Kits

These kits contain the parts needed to repair and beautify your old worn out tub and shower valves. Each kit contains new operating components along with the trim and handles needed to revitalize your classic valve. After installing one of these professional grade renovation kits, your tub and shower valve will work and look like new.

Kit# 111882▲



FITS STERLING

- 3-Handle Valve
- Contains All Pictured Parts

Individual Stem Numbers:
Lincoln: 102323 - hot/cold

Kit# 111883▲



FITS STERLING

- 2-Handle Valve
- Contains All Pictured Parts

Kit# 111884▲



FITS STERLING

- 3-Handle Valve
- Contains All Pictured Parts

Kit# 111885▲



FITS STERLING

- 2-Handle Valve
- Contains All Pictured Parts

Individual Stem Numbers:
Lincoln: 102422 - hot/cold

Kit# 111886▲



FITS STERLING

- 3-Handle Valve
- Contains All Pictured Parts

Individual Stem Numbers:
Lincoln: 102422 - hot/cold

Kit# 111892▲



FITS UNION BRASS

- 3-Handle Valve
- Contains All Pictured Parts

Individual Stem Numbers:
Lincoln: 122301 - hot/cold

Kit# 111893▲



FITS UNION BRASS

- 2-Handle Valve
- Contains All Pictured Parts

Individual Stem Numbers:
Lincoln: 121235 - hot
121285 - cold



Mixet®

Fits Mixet® tub and shower valves. Includes escutcheon, round handle and lever handle.



STOCK#	PACK	CASE	DESCRIPTION	MFG#	UPC#
132250▲	4		STANDARD 5-1/2" CHROME PLATED	MTR-5 1	054374107070
132251▲	4		DELUXE 5-1/2" CHROME PLATED	MDXTR-5	054374095841

Fits Mixet tub and shower valves. Includes: 4-1/2" escutcheon, volume control round handle (clear acrylic) and temperature control lever handle (clear acrylic).



132249▲	1	3	4-1/2" CLEAR/CHROME PLATED		054374464814
---------	---	---	----------------------------	--	--------------

Fits Mixet tub and shower valves. Includes: 5-1/2" escutcheon, volume control loop handle, temperature control lever handle and retainer nut.



132245▲	1	3	5-1/2" LOOP HANDLE SATIN NICKEL		054374846481
---------	---	---	---------------------------------	--	--------------

Fits Mixet tub and shower valves. Includes: 5-1/2" escutcheon, volume control round handle (clear acrylic), temperature control lever handle (metal).



132253▲	1	4	5-1/2" CLEAR/CHROME PLATED		054374648146
---------	---	---	----------------------------	--	--------------

Moen® Chateau

Fits Moen® Chateau tub and shower valves. Includes escutcheon, sleeve and handle.



STOCK#	PACK	CASE	DESCRIPTION	UPC#
102280▲	6		TUB & SHOWER TRIM	054374113705

Moen® Legend

Fits Moen® Legend tub and shower valves. Includes escutcheon, sleeve and handle.



STOCK#	PACK	CASE	DESCRIPTION	UPC#
102254▲	6		TUB & SHOWER TRIM	054374156306

Pfister® Avante

Fits Pfister® Avante tub and shower valves. Includes escutcheon, sleeve and handle.



STOCK#	PACK	CASE	DESCRIPTION	MFG#	UPC#
102273▲	3		AVANTE TUB & SHOWER TRIM KIT	GENERIC	05437415635

Pfister® Verve



STOCK#	PACK	CASE	DESCRIPTION	MFG#	UPC#
132270	3		TUB & SHOWER TRIM KIT	GENUINE	054374104932
102270▲	6		TUB & SHOWER TRIM KIT	GENERIC	054374104956

Pfister® Windsor



STOCK#	PACK	CASE	DESCRIPTION	MFG#	UPC#
132272	3		TUB & SHOWER TRIM KIT	GENUINE	054374104925
102272▲	6		TUB & SHOWER TRIM KIT	GENERIC	054374104949

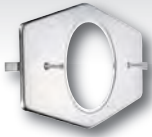

Repair Plates

Converts two or three handle tub and shower installation to single control. includes mounting hardware.

STOCK#	PACK	CASE	DESCRIPTION	UPC#
102213▲	25	250	ONE HOLE STAINLESS STEEL	054374920907



Delta® Flange Screws

Flange screws for chrome tub & shower trim plates.

STOCK#	PACK	CASE	DESCRIPTION	MFG#	UPC#
131500	6	144	SCREWS - 2 PER CARD	RP196	054374109838



Delta® Renovation Plate

This renovation plate easily converts a 2 or 3 handle tub/shower installation to any Delta® single handle tub/shower valve. Includes screws.

STOCK#	PACK	CASE	DESCRIPTION	MFG#	UPC#
132262	1		CHROME PLATED	RP29827	034449413404

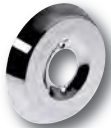

Kohler® Mixer Escutcheon Assembly

STOCK#	PACK	CASE	DESCRIPTION	MFG#	UPC#
131789	1		POLISHED CHROME	76602-CP	040688967820



Moen® Trim Plates

Fits Moen® tub and shower valves (non-diverter). Includes escutcheon plate and screws.

STOCK#	PACK	CASE	DESCRIPTION	MFG#	UPC#
132256▲	12		CHATEAU CHROME PLATED	M165090	054374094936



For Legend or Chateau shower valves. Chrome Plated.

131501▲	6	144	SCREWS	15528	054374110032
---------	---	-----	--------	-------	--------------



Moen® Stop Tubes

Fits Moen® Chateau and Legend single handle tub and shower valves.

STOCK#	PACK	CASE	DESCRIPTION	MFG#	UPC#
131150	6	72	CHROME PLATED	10089	054374105670



Fits Moen® Posi-Temp tub and shower valves.

131506	6	72	CHROME PLATED	96987	054374110049
--------	---	----	---------------	-------	--------------





Fit-All Shower Flange

Includes tapered escutcheon nipple and two-piece escutcheon. Adapts to all styles and depth of shower valves.

STOCK#	PACK	CASE	DESCRIPTION	UPC#
102222▲	6	48	CHROME PLATED	054374113668



Harcraft® Shower Flange

Fits Harcraft® shower valves.

STOCK#	PACK	CASE	DESCRIPTION	UPC#
102240▲	6	48	CHROME PLATED	054374112753



Pfister® Shower Valve Flanges

Chrome plated flange to fit Pfister® valves. Hexagon style.

STOCK#	PACK	CASE	DESCRIPTION	MFG#	UPC#
132206▲	6	48	OLD STYLE	960-280	054374094486

Chrome plated flange to fit Pfister® valves.

132207	6	48	NEW STYLE	960-110A	054374094493
102207▲	6	48	NEW STYLE		054374005307
102219▲	12		TEARDROP STYLE		054374783137



Pfister® 2 Piece Shower Flanges

Shower flange and sleeve to fit Pfister® Crown Imperial and new style shower valves. Includes set screw.

STOCK#	PACK	CASE	DESCRIPTION	MFG#	UPC#
132208	6	48	CHROME PLATED	S60-151A	054374094509



Pfister® Widespread Flanges

Chrome plated. Fits widespread lavatory faucets.

STOCK#	PACK	CASE	DESCRIPTION	MFG#	UPC#
132213▲	6	48	CHROME PLATED	S60-160A	054374094523

Nuts and Nipples

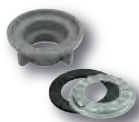

1/2" Locknut and Rosette

Fits 1/2" IPS faucet shank.

STOCK#	PACK	CASE	DESCRIPTION	MFG#	UPC#
101800▲	6	144	LOCKNUT, ROSETTE AND WASHER	CARDED	054374004881
129678▲	12	144	1/2" PLASTIC LOCKNUT	BAGGED	054374077526
129679	12	144	BASIN ROSETTE	BAGGED	054374077533



Faucet Nuts

Fits 1/2" IPS faucet shank.

STOCK#	PACK	CASE	DESCRIPTION	UPC#
101606▲	6	144	1/2" SHANK X 3/8" TUBE	054374889662
101602▲	6	144	1/2" SHANK X 1/2" TUBE	054374641970



Pfister® Escutcheon Nipples

Fits all Pfister® tub and shower valves. Use to adjust depth of flange.

STOCK#	PACK	CASE	DESCRIPTION	MFG#	UPC#
102211▲	6	72	PLASTIC - 1 PER CARD		054374114504
132212▲	6	72	PLASTIC - 3 PER CARD	S72-111	054374094516
102212▲	6	144	PLASTIC - 3 PER CARD	GENERIC	054374005345

How to Find a Replacement Stem

SECTION 5 • PAGE 14



4 **AMERICAN STANDARD**
072950-1700AP • 072951-1700AP
Aquaseal

4 **DELTA**
RP46074
Pressure Balance
Cartridge (OEM)
For 1300/1400 Series

- 6**
- Hot (OEM) ▲130420
 - Cold (OEM) ▲130470
 - Hot ▲100420
 - Cold ▲100470
 - Renovation Kit ▲111816
 - Renovation Kit ▲111881
 - Bonnet O-Ring 128035
 - Faucet Washer 130120
 - Faucet Washer 100120
 - Faucet Washer (OEM) 128521
 - Seat ▲120145

▲131749

- 1) Measure the length, then turn to appropriate range section of this catalog.
- 2) Count the splines (raised at the tip of the stem/cartridge or identify the shape to match accuracy and handle fit.
- 3) Compare your part to the true-size images on the pages.
- 4) As reference, note the original manufacture part number where available.
- 5) The first two digits of the stock number designate product type as follows:

Numbers starting with:

- 10 = Lincoln Products Carded generic parts
- 11 = Lincoln Products Boxed generic Renovation Kits
- 12 = Lincoln Products Bagged generic parts
- 13 & 14 = Genuine Manufacturer's Carded parts in their packaging
- 68 = Genuine Manufacturer's Bagged parts

6) ▲PROP65 WARNING FOR CALIFORNIA RESIDENTS. This product can contain chemicals known to the State of California to cause cancer, birth defects or other reproductive harm.



▲ For Proposition 65 warnings please refer to pages 93-124 at the end of this section.

All Products Used for Potable Water are:



Hot / Cold Stems up to 2"

FAUCET REPAIR

CARDED = 10 (Lincoln) • 13 & 14 (OEM) • BAGGED = 68 (OEM) • 11 & 12 (Lincoln) • BOXED = 11 (Lincoln).

 Broach Not to Scale • Images Are Actual Size



AMERICAN BRASS®

Hot/Cold ▲390035
For RV & Mobile Home



AMERICAN STANDARD® Cadet

Hot/Cold ▲101274
Renovation Kit ▲111817
Renovation Kit ▲111818
Faucet Washer 128522
Seat (Short) ▲120148

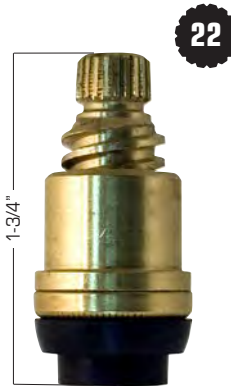

AMERICAN STANDARD® Aquaseal

Hot (OEM) ▲130420
Cold (OEM) ▲130470
Hot ▲100420
Cold ▲100470
Renovation Kit ▲111816
Renovation Kit ▲111881
Bonnet O-Ring 128035
Faucet Washer (OEM) 130120
Faucet Washer 100120
Faucet Washer 128521



AMERICAN STANDARD® Re-Nu

Hot (OEM) ▲130418
Cold (OEM) ▲130468
Hot ▲100418
Cold ▲100468
Renovation Kit ▲111819
Renovation Kit ▲111824
Bonnet O-Ring 128035
Faucet Washer 128452
Bibb Screw ▲128252
Seat ▲101145



AMERICAN STANDARD® Colony

Hot/Cold (OEM) 130425



AMERICAN STANDARD® Monterrey

Hot/Cold (OEM) 130422



ARTISTIC BRASS®

Ceramic Disc
Hot ▲101630
Cold ▲101680



BRISTOL®

Hot/Cold ▲101255
Bonnet Gasket 128016
Stem O-Ring 128007
O-Ring 128006



DELTA® RP1740

Hot/Cold (OEM) 111147, 131147
Hot/Cold (OEM) 6PK 119907
O-Ring 128030
O-Ring 128015
Seats & Springs (OEM) 131139



DELTA® RP47422

Ceramic Disc
Hot/Cold 131751



▲ For Proposition 65 warnings please refer to pages 93-124 at the end of this section.

All Products Used for Potable Water are:



Hot / Cold Stems up to 2"

CARDED = 10 (Lincoln) • 13 & 14 (OEM) • BAGGED = 68 (OEM) • 11 & 12 (Lincoln) • BOXED = 11 (Lincoln).

Broach Not to Scale • Images Are Actual Size



DELTA®
RP25513

Hot/Cold (OEM) 131744



DELTA®
RP24096

Hot/Cold (OEM) 131747



GERBER®
98-688 • 98-689

Hot (OEM) ▲680901
Cold (OEM) ▲680902



GERBER®
98-682

Hot Cold ▲101231
▲101281

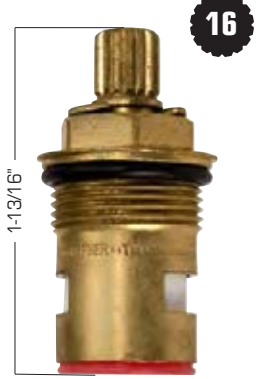

GERBER®
86-987 • 86-986

Ceramic Disc
Hot (OEM) ▲680907
Cold (OEM) ▲680908
Hot ▲122305
Cold ▲122307



GLACIER BAY®

Ceramic Disc
Hot ▲101626
Cold ▲101676



GLACIER BAY®

Ceramic Disc
Hot ▲101627
Cold ▲101677



KOHLER®

GP1152349 • GP1152350
Ceramic Disc
Hot (OEM) ▲132910
Cold (OEM) ▲132911



KINGSTON BRASS®

Hot Cold ▲100425
▲100424
For KF102, 100, 200



**NIBCO®, LIFETIME®,
STREAMWAY®**

Hot ▲101240
Cold ▲101290



SECTION 5 • PAGE 16

Hot / Cold Stems up to 2"

FAUCET REPAIR

CARDED = 10 (Lincoln) • 13 & 14 (OEM) • BAGGED = 68 (OEM) • 11 & 12 (Lincoln) • BOXED = 11 (Lincoln).

Broach Not to Scale • Images Are Actual Size

 <p>1-7/16"</p>	 <p>1-3/4"</p>	 <p>1-13/16"</p>	 <p>1-13/16"</p>	 <p>1-7/8"</p>																																																						
<p>PFISTER® 910-072 • 910-082</p> <table border="0"> <tr><td>Hot (OEM)</td><td>130400</td></tr> <tr><td>Cold (OEM)</td><td>130450</td></tr> <tr><td>Hot</td><td>▲100400</td></tr> <tr><td>Cold</td><td>▲100450</td></tr> <tr><td>Stem O-Ring</td><td>128031</td></tr> <tr><td>Faucet Washer</td><td>128451</td></tr> <tr><td>Bibb Screw</td><td>▲128258</td></tr> <tr><td>Seat (OEM)</td><td>131113</td></tr> <tr><td>Seat</td><td>▲120109, ▲101109</td></tr> <tr><td>Repair Kit (OEM)</td><td>▲131100</td></tr> </table>	Hot (OEM)	130400	Cold (OEM)	130450	Hot	▲100400	Cold	▲100450	Stem O-Ring	128031	Faucet Washer	128451	Bibb Screw	▲128258	Seat (OEM)	131113	Seat	▲120109, ▲101109	Repair Kit (OEM)	▲131100	<p>PFISTER® 910-392 • S10-393</p> <table border="0"> <tr><td>Hot/Cold (OEM)</td><td>130403</td></tr> <tr><td>Hot/Cold (OEM) w/seat</td><td>130486</td></tr> <tr><td>Hot/Cold (OEM) 12-PK</td><td>130412</td></tr> <tr><td>Hot/Cold</td><td>▲100403</td></tr> <tr><td>Stem O-Ring</td><td>128031</td></tr> <tr><td>Faucet Washer</td><td>128451</td></tr> <tr><td>Bibb Screw</td><td>▲128258</td></tr> <tr><td>Seat (OEM)</td><td>131113</td></tr> <tr><td>Seat</td><td>▲120109, ▲101109</td></tr> <tr><td>Repair Kit (OEM)</td><td>▲131100</td></tr> </table>	Hot/Cold (OEM)	130403	Hot/Cold (OEM) w/seat	130486	Hot/Cold (OEM) 12-PK	130412	Hot/Cold	▲100403	Stem O-Ring	128031	Faucet Washer	128451	Bibb Screw	▲128258	Seat (OEM)	131113	Seat	▲120109, ▲101109	Repair Kit (OEM)	▲131100	<p>PFISTER® S10-900</p> <p>Ceramic Disc</p> <table border="0"> <tr><td>Hot/Cold (OEM)</td><td>130453</td></tr> <tr><td>O-Ring</td><td>128031</td></tr> </table>	Hot/Cold (OEM)	130453	O-Ring	128031	<p>PFISTER® 974-283 • 974-285</p> <p>Ceramic Disc</p> <table border="0"> <tr><td>Hot (OEM)</td><td>130455</td></tr> <tr><td>Cold (OEM)</td><td>130456</td></tr> </table>	Hot (OEM)	130455	Cold (OEM)	130456	<p>PFISTER® 974-013</p> <table border="0"> <tr><td>Hot & Cold (OEM)</td><td>▲131281</td></tr> <tr><td>With Seats & Springs</td><td></td></tr> </table>	Hot & Cold (OEM)	▲131281	With Seats & Springs			
Hot (OEM)	130400																																																									
Cold (OEM)	130450																																																									
Hot	▲100400																																																									
Cold	▲100450																																																									
Stem O-Ring	128031																																																									
Faucet Washer	128451																																																									
Bibb Screw	▲128258																																																									
Seat (OEM)	131113																																																									
Seat	▲120109, ▲101109																																																									
Repair Kit (OEM)	▲131100																																																									
Hot/Cold (OEM)	130403																																																									
Hot/Cold (OEM) w/seat	130486																																																									
Hot/Cold (OEM) 12-PK	130412																																																									
Hot/Cold	▲100403																																																									
Stem O-Ring	128031																																																									
Faucet Washer	128451																																																									
Bibb Screw	▲128258																																																									
Seat (OEM)	131113																																																									
Seat	▲120109, ▲101109																																																									
Repair Kit (OEM)	▲131100																																																									
Hot/Cold (OEM)	130453																																																									
O-Ring	128031																																																									
Hot (OEM)	130455																																																									
Cold (OEM)	130456																																																									
Hot & Cold (OEM)	▲131281																																																									
With Seats & Springs																																																										
 <p>1-7/8"</p>	 <p>1-15/16"</p>	 <p>2"</p>	 <p>2"</p>	 <p>1-3/4"</p>																																																						
<p>PFISTER® 910-282 • 910-292</p> <table border="0"> <tr><td>Hot</td><td>▲100401</td></tr> <tr><td>Cold</td><td>▲100451</td></tr> <tr><td>Stem O-Ring</td><td>128031</td></tr> <tr><td>Faucet Washer</td><td>128451</td></tr> <tr><td>Bibb Screw</td><td>▲128258</td></tr> <tr><td>Seat (OEM)</td><td>131113</td></tr> <tr><td>Seat</td><td>▲101109, ▲120109</td></tr> <tr><td>Repair Kit (OEM)</td><td>▲131100</td></tr> </table>	Hot	▲100401	Cold	▲100451	Stem O-Ring	128031	Faucet Washer	128451	Bibb Screw	▲128258	Seat (OEM)	131113	Seat	▲101109, ▲120109	Repair Kit (OEM)	▲131100	<p>PFISTER® 910-402</p> <table border="0"> <tr><td>Hot/Cold (OEM)</td><td>130427</td></tr> <tr><td>Stem O-Ring</td><td>128031</td></tr> <tr><td>Faucet Washer</td><td>128451</td></tr> <tr><td>Bibb Screw</td><td>▲128258</td></tr> <tr><td>Seat (OEM)</td><td>131113</td></tr> <tr><td>Seat</td><td>▲101109, ▲120109</td></tr> <tr><td>Repair Kit (OEM)</td><td>▲131100</td></tr> </table>	Hot/Cold (OEM)	130427	Stem O-Ring	128031	Faucet Washer	128451	Bibb Screw	▲128258	Seat (OEM)	131113	Seat	▲101109, ▲120109	Repair Kit (OEM)	▲131100	<p>PFISTER® S10-681 • S10-691</p> <table border="0"> <tr><td>Hot</td><td>▲100409</td></tr> <tr><td>Cold</td><td>▲100459</td></tr> <tr><td>Washers (OEM) 131112, 131559</td><td></td></tr> <tr><td>Washers</td><td>▲101112</td></tr> </table>	Hot	▲100409	Cold	▲100459	Washers (OEM) 131112, 131559		Washers	▲101112	<p>PFISTER® 910-031 • 910-032</p> <p>Ceramic Disc</p> <table border="0"> <tr><td>Hot (OEM)</td><td>131766</td></tr> <tr><td>Cold (OEM)</td><td>130454</td></tr> <tr><td>For Widespread Valve Body</td><td></td></tr> <tr><td>(See Page# 17)</td><td></td></tr> </table>	Hot (OEM)	131766	Cold (OEM)	130454	For Widespread Valve Body		(See Page# 17)		<p>PHOENIX®</p> <table border="0"> <tr><td>Hot/Cold</td><td>▲100463</td></tr> <tr><td>O-Ring</td><td>128031</td></tr> <tr><td>Faucet Washer</td><td>128451</td></tr> <tr><td>Bibb Screw</td><td>▲128252</td></tr> </table>	Hot/Cold	▲100463	O-Ring	128031	Faucet Washer	128451	Bibb Screw	▲128252
Hot	▲100401																																																									
Cold	▲100451																																																									
Stem O-Ring	128031																																																									
Faucet Washer	128451																																																									
Bibb Screw	▲128258																																																									
Seat (OEM)	131113																																																									
Seat	▲101109, ▲120109																																																									
Repair Kit (OEM)	▲131100																																																									
Hot/Cold (OEM)	130427																																																									
Stem O-Ring	128031																																																									
Faucet Washer	128451																																																									
Bibb Screw	▲128258																																																									
Seat (OEM)	131113																																																									
Seat	▲101109, ▲120109																																																									
Repair Kit (OEM)	▲131100																																																									
Hot	▲100409																																																									
Cold	▲100459																																																									
Washers (OEM) 131112, 131559																																																										
Washers	▲101112																																																									
Hot (OEM)	131766																																																									
Cold (OEM)	130454																																																									
For Widespread Valve Body																																																										
(See Page# 17)																																																										
Hot/Cold	▲100463																																																									
O-Ring	128031																																																									
Faucet Washer	128451																																																									
Bibb Screw	▲128252																																																									

Hot / Cold Stems up to 2"

CARDED = 10 (Lincoln) • 13 & 14 (OEM) • BAGGED = 68 (OEM) • 11 & 12 (Lincoln) • BOXED = 11 (Lincoln).

Broach Not to Scale • Images Are Actual Size



PHOENIX®

Hot/Cold ▲101262
Bonnet Gasket 128042
Outside O-Ring 128010
Inside O-Ring 128030



PROFLO™

PFX141198 • PFX141197

Hot (OEM) ▲141198
Cold (OEM) ▲141197



PROFLO™

PFX141192PK • PFX141199PK

Hot (OEM) ▲141192
Cold (OEM) ▲141199
O-Ring 128030
O-Ring 128015
Seats & Springs ▲141191



PROFLO™

PFX141561 • PFX141560

Ceramic Disc
Hot (OEM) ▲141561
Cold (OEM) ▲141560



PROFLO™

PFX141562 • PFX141563

20mm Cartridge
Hot (OEM) ▲141562
Cold (OEM) ▲141563



SAYCO®

Hot ▲100414
Cold ▲100464
Bonnet O-Ring 128010
Stem O-Ring 128031
Faucet Washer 128451
Bibb Screw ▲128252
Seat ▲120130



STREAMWAY®

Hot ▲390085
Cold ▲390084
For RV & Mobile Home



STREAMWAY®

Hot/Cold ▲390058
For RV & Mobile Home

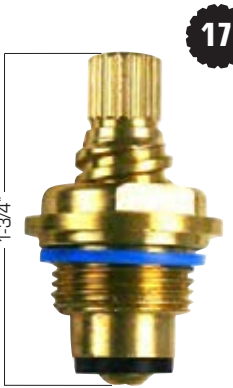

STREAMWAY®

Hot ▲100416
Cold ▲100466
O-Ring 128031
Faucet Washer 128451
Bibb Screw ▲128252
Seat ▲120149



VALLEY®

Hot/Cold ▲101229
O-Ring 128031
O-Ring 128015
Seats & Springs ▲101161



Hot / Cold Stems up to 3"

CARDED = 10 (Lincoln) • 13 & 14 (OEM) • BAGGED = 68 (OEM) • 11 & 12 (Lincoln) • BOXED = 11 (Lincoln).

Broach Not to Scale • Images Are Actual Size



20

ALTMANS / SEARS / UR / PHYLRICH / CONCINNITY

Ceramic Disc

Hot	▲101632
Cold	▲101682



16

ALTMANS / SIGMA / PAUL

Ceramic Disc

Hot	▲101633
Cold	▲101683



30

AMERICAN STANDARD®
028610-0070AP

Hot/Cold (OEM)	130424
Includes adapter and screw	



CHICAGO®
1-099XKJKABNF • 1-100XKJKABNF

Ceramic Disc

Hot (OEM)	▲131589
Cold (OEM)	▲131588



CHICAGO®
217-XTLHJKABNF
217-XTRHJKABNF

1/2 Turn

Hot (OEM)	▲131560
Cold (OEM)	▲131561
Packing	128335
O-Ring	128032
Faucet Washer Kit	128523
	▲101119



CHICAGO®
1-099XTJKABNF • 1-100XTJKABNF

1/4 Turn

Hot (OEM)	▲131578
Cold (OEM)	▲131577
Hot	▲100421
Cold	▲100471
Packing	128335
O-Ring	128032
Faucet Washer Kit	128523
	▲101119



CHICAGO®
377-XKLHJKABNF
377-XKRHJKABNF

Ceramic Disc

Hot (OEM)	▲131592
Cold (OEM)	▲131593



12

CRANE®

Hot	▲100411
Cold	▲100461
O-Ring	128061
Faucet Washer	128524

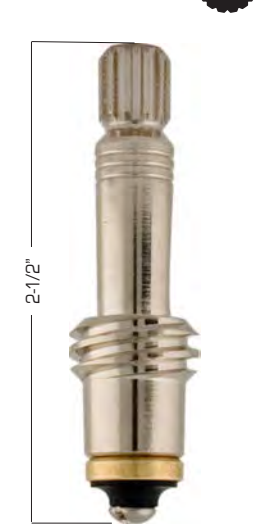

18

FISHER®
54502 • 54510

Hot w/handle (OEM)	▲680720
Cold w/handle (OEM)	▲680721

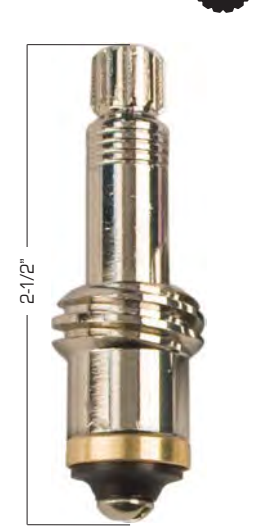

18

FISHER®
54518 • 54526

Hot w/handle (OEM)	▲680728
Cold w/handle (OEM)	▲680729



Hot / Cold Stems up to 3"

CARDED = 10 (Lincoln) • 13 & 14 (OEM) • BAGGED = 68 (OEM) • 11 & 12 (Lincoln) • BOXED = 11 (Lincoln).

Broach Not to Scale • Images Are Actual Size

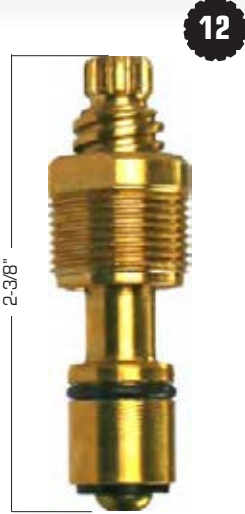

HARCRAFT®

- Hot/Cold ▲100429
- O-Ring 128031
- O-Ring 128008
- Faucet Washer 128451
- Bibb Screw ▲128258



JADO®/ GROHE®

- Ceramic Disc**
- Hot ▲101637
 - Cold ▲101687



KOHLER®

- Hot ▲100430
- Cold ▲100480
- O-Ring 128031
- Faucet Washer 128451
- Bibb Screw ▲128252
- Seat ▲120129



KOHLER®

GP77005-RP • GP77006-RP

- Hot (OEM) 131544
- Cold (OEM) 131545



KOHLER®

GP30002 • GP30004

- Hot ▲100415
- Cold ▲100465
- Renovation Kit ▲111870
- Renovation Kit ▲111872
- O-Ring 128031
- Faucet Washer 128451
- Bibb Screw ▲128252
- Seat ▲120129



KOHLER®

GP330002 • GP330004

Valvet

- Ceramic Disc - 1/4 Turn**
- Hot (OEM) ▲131235
 - Cold (OEM) ▲131285



KOHLER®

Ceramic Disc

- Hot ▲101643
- Cold ▲101693



KOHLER®

GP1092204 • GP1092205

1/4 Turn

- Hot (OEM) ▲132905
- Cold (OEM) ▲132904



MOEN® / STANDYNE®

1224

- Hot/Cold (OEM) 131222
- Hot/Cold (OEM) 119924
- Hot/Cold ▲101222
- Hot/Cold 5PK ▲110122
- O-Ring 128034



MOEN®

1248b

- Hot/Cold (OEM) 119923
- O-Ring 128034



SECTION 5 • PAGE 20

Hot / Cold Stems up to 3"

FAUCET REPAIR

CARDED = 10 (Lincoln) • 13 & 14 (OEM) • **BAGGED** = 68 (OEM) • 11 & 12 (Lincoln) • **BOXED** = 11 (Lincoln).

Broach Not to Scale • Images Are Actual Size



NEWPORT BRASS / SANTEC / CONCINNITY

Ceramic Disc
Hot ▲101645
Cold ▲101695



PFISTER®
910-394

Hot/Cold ▲100448



PFISTER®
910-403

Hot/Cold (OEM) ▲132418
Hot/Cold ▲102418
O-Ring ▲128031
Faucet Washer 128451
Bibb Screw 128258
Seat (OEM) ▲120108, ▲131108
Seat ▲101108



PFISTER®
910-413

Hot/Cold (OEM) ▲132419



PROFLO™
PF141554PK

Hot/Cold (OEM) ▲141554



PROFLO™
PFX653707 • PFX650106

Ceramic Disc
Hot (OEM) ▲141590
Cold (OEM) ▲141591



PROFLO™
PF141579PK

Ceramic Disc
Hot & Cold (OEM) ▲141579
Roman Tub



SPEAKMAN®

Ceramic Disc
Hot ▲101641
Cold ▲101691



T&S BRASS®
002712-40 • 002711-40

Hot w/handle (OEM) ▲680788
Cold w/handle (OEM) ▲680787
Eterna Spindle Assembly,
Spring Check



T&S BRASS®
002714-40 • 002713-40

Hot w/handle (OEM) ▲680804
Cold w/handle (OEM) ▲680803
Barrel Hot (OEM) ▲680811
Barrel Cold (OEM) ▲680812



Hot / Cold Stems up to 3" & 4"

CARDED = 10 (Lincoln) • 13 & 14 (OEM) • BAGGED = 68 (OEM) • 11 & 12 (Lincoln) • BOXED = 11 (Lincoln).

 Broach Not to Scale • Images Are Actual Size



VALLEY®

Hot/Cold ▲101225

20



BROADWAY

Ceramic Disc

Hot (OEM) ▲101622
Cold (OEM) ▲101672



CHICAGO®
377-XTLHJKABNF
377-XTRHJKABNF

Hot (OEM) ▲131581
Cold (OEM) ▲131582

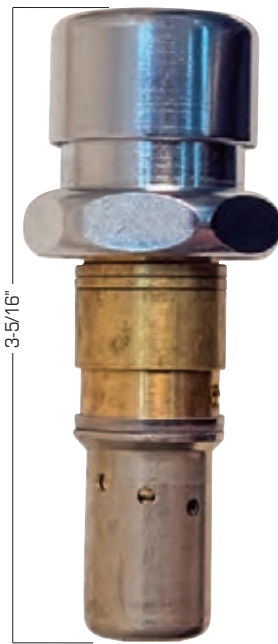

CHICAGO®
628-XJKABNF

**Push Button Cartridge
For Pedal Valves**

Hot/Cold (OEM) ▲131562



CHICAGO®
333-XPSHJKABNF

Push Button Cartridge

Hot/Cold (OEM) ▲131583



CHICAGO®
628-XSLOJKABNF

**Slow Close Push Button
Cartridge**

Hot/Cold (OEM) ▲131585
Dashpot Set (OEM) ▲131567



SECTION 5 • PAGE 22

Hot / Cold Stems up to 4"

CARDED = 10 (Lincoln) • 13 & 14 (OEM) • BAGGED = 68 (OEM) • 11 & 12 (Lincoln) • BOXED = 11 (Lincoln).

Broach Not to Scale • Images Are Actual Size

16



HARDEN®

Ceramic Disc
 Hot ▲101625
 Cold ▲101675

12



PFISTER®
 S10-830 • S10-835
Coralais

Hot (OEM) 132336
 Cold (OEM) 132386
 Hot ▲100483
 Cold ▲100484
 O-Ring 128031
 O-Ring 128015
 Repair Kit (OEM) ▲131112
 Repair Kit (OEM) 131559
 Repair Kit ▲101112

20



SPEAKMAN®

Ceramic Disc
 Hot ▲101647
 Cold ▲101697

16

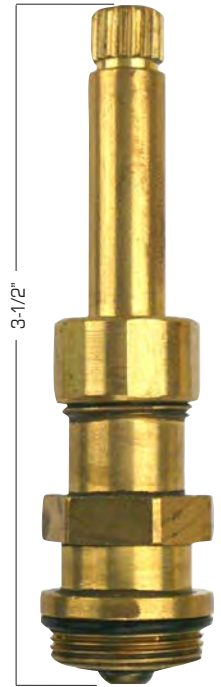

STERLING®

Hot/Cold Seat ▲102311
 ▲101122, ▲120122

SECTION 5 • PAGE 23

Hot / Cold Stems up to 5"

CARDED = 10 (Lincoln) • 13 & 14 (OEM) • **BAGGED** = 68 (OEM) • 11 & 12 (Lincoln) • **BOXED** = 11 (Lincoln).

Broach Not to Scale • Images Are Actual Size



AMERICAN STANDARD®
Colony

- Hot/Cold ▲102324
- Renovation Kit ▲111832
- Renovation Kit ▲111833
- Faucet Washer 128452
- Bibb Screw ▲128252
- Seat ▲101150, ▲120150

ELJER®

- Hot/Cold ▲102332
- Renovation Kit ▲111850
- Renovation Kit ▲111851

ELJER®

- Hot ▲102330
- Cold ▲102331

HARCRAFT®

- Hot/Cold ▲102414
- Renovation Kit ▲111856
- Renovation Kit ▲111859
- Renovation Kit ▲111860
- Stem O-Ring 128031
- O-Ring 128008
- Faucet Washer 128451
- Bibb Screw ▲128258

HARDEN®

- Ceramic Disc**
- Hot ▲101624
- Cold ▲101674



SECTION 5 • PAGE 24

Hot / Cold Stems up to 5"

CARDED = 10 (Lincoln) • 13 & 14 (OEM) • BAGGED = 68 (OEM) • 11 & 12 (Lincoln) • BOXED = 11 (Lincoln).

 Broach Not to Scale • Images Are Actual Size

16 19 12 12 12



KOHLER®
Trend/Shore
Hot/Cold ▲102318
Cold (lever only) ▲102368

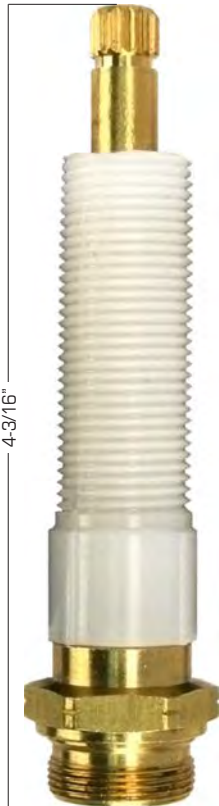

KOHLER®
GP30119
Trend/Shore
Hot/Cold (OEM) 132389
Hot/Cold ▲102344
Renovation Kit ▲111864
Renovation Kit ▲111865
Renovation Kit ▲111873
O-Ring 128031
Faucet Washer 128451
Bibb Screw ▲128252
Seat ▲120129



PFISTER®
910-013 • 910-034 • S10-013
S10-034
Hot/Cold (OEM) 132409
Hot/Cold w/seat (OEM) ▲112443
Hot/ Cold w/seat(OEM) ▲132443
Hot Only "OEM" ▲132459
Hot Only w/seat (OEM) ▲132444
Hot/Cold ▲102409
Bonnet Gasket 128413
Packing 128342
Faucet Washer 128457
Bibb Screw ▲128258
Seat (OEM) ▲120108, ▲131108
Seat ▲101108
Repair Kit (OEM) 131104
Repair Kit (OEM) ▲131154



PFISTER®
974-221
Ceramic Disc 1/2 Turn
Hot/Cold (OEM) 131256
Roman Tub cartridge Used in
OX6 Valve



PFISTER®
S10-030
Ceramic Disc
Hot/Cold (OEM) ▲131254

SECTION 5 • PAGE 25



Hot / Cold Stems up to 5"

CARDED = 10 (Lincoln) • 13 & 14 (OEM) • BAGGED = 68 (OEM) • 11 & 12 (Lincoln) • BOXED = 11 (Lincoln).

Broach Not to Scale • Images Are Actual Size

SECTION 5 • PAGE 26

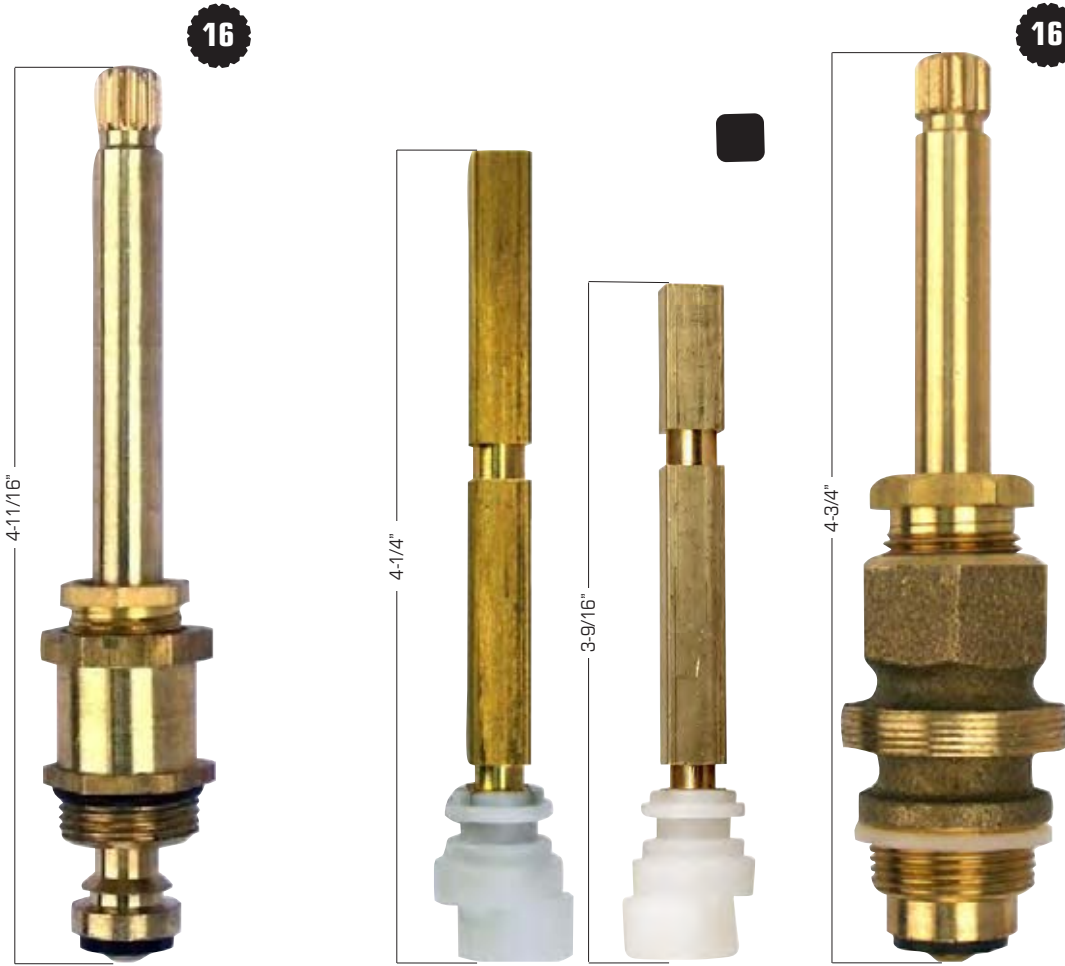

SAYCO®

- Hot/Cold ▲102326
- Renovation Kit ▲111877
- Renovation Kit ▲111875
- O-Ring 128035
- Faucet Washer 128451
- Bibb Screw ▲128252
- Seat ▲120130

STERLING®

- Hot/Cold ▲102323
- Repair Kit w/2 Length Stems
- Renovation Kit ▲111880
- Renovation Kit ▲111882
- O-Ring 128015
- Stem O-Ring 128031
- O-Ring 128006

STERLING®

- Hot/Cold ▲102308
- Renovation Kit ▲111878
- Renovation Kit ▲111871
- Bonnet Gasket 128413
- Faucet Washer 128454
- Bibb Screw ▲128252
- Seat ▲101122, ▲120122



Hot / Cold Stems up to 6"

CARDED = 10 (Lincoln) • 13 & 14 (OEM) • **BAGGED** = 68 (OEM) • 11 & 12 (Lincoln) • **BOXED** = 11 (Lincoln).

Broach Not to Scale • Images Are Actual Size



AMERICAN STANDARD®
009806-0020AP
Tractline

- Hot/Cold (OEM) ▲132333
- Renovation Kit ▲111828
- Renovation Kit ▲111829
- Bonnet Gasket 128413
- Faucet Washer 128452
- Bibb Screw ▲128258

AMERICAN STANDARD®
Colony

- Hot/Cold ▲102317
- Renovation Kit ▲111831
- Packing 128328
- Faucet Washer 128451
- Bibb Screw ▲128252
- Seat ▲101150, ▲120150

AMERICAN STANDARD®
18293-0200AP
Renu

- Hot/Cold (OEM) ▲132433
- Hot/Cold ▲102433
- Renovation Kit ▲111826
- Renovation Kit ▲111827
- Bonnet Gasket 128433
- Packing 128341
- Faucet Washer 128452
- Bibb Screw ▲128252

GERBER®
98-673 • 98-674 • 98-004

- Hot (OEM) 680900
- Cold (OEM) 680914
- Hot w/seat (OEM) 680912

GERBER®

- Hot/Cold ▲102435
- Renovation Kit ▲111853
- Renovation Kit ▲111879
- Renovation Kit ▲111854
- Renovation Kit ▲111855



Hot / Cold Stems up to 6"

CARDED = 10 (Lincoln) • 13 & 14 (OEM) • BAGGED = 68 (OEM) • 11 & 12 (Lincoln) • BOXED = 11 (Lincoln).

Broach Not to Scale • Images Are Actual Size

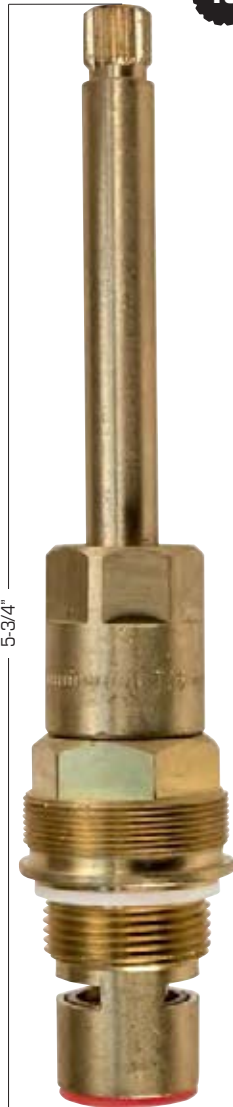

16

GERBER®
98-705 • 98-709

Ceramic Disc	
Hot (OEM)	680911
Cold (OEM)	680921



18

PFISTER®
S10-710 • S10-701

Hot/Cold (OEM)	130489
Cold Lever Only (OEM)	130490
Hot/Cold	▲100489
Cold Lever Only	▲100490
O-Ring	128031
O-Ring	128015
Repair Kit (OEM)	▲131112
Repair Kit (OEM)	131559
Repair Kit	▲101112

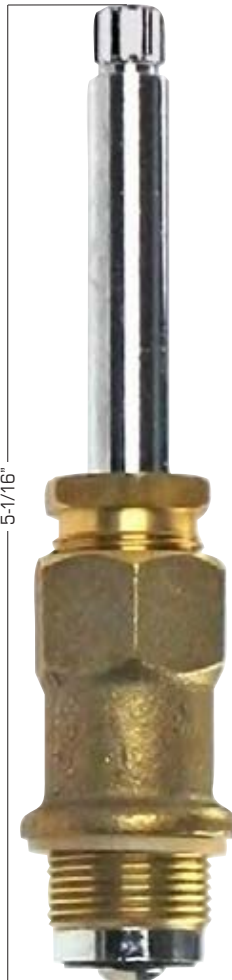

12

PFISTER®
910-043
Beaux Art

Hot/Cold (OEM)	▲132403
Hot/Cold	▲102453
Bonnet Gasket	128413
Packing	128342
Faucet Washer	128457
Bibb Screw	▲128258
Seat (OEM)	▲120108, ▲131108
Seat	▲101108
Repair Kit (OEM)	131104

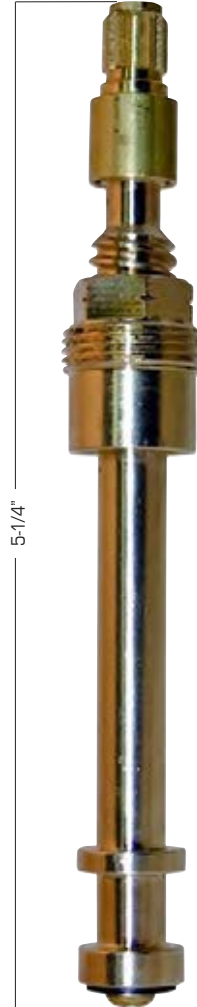

12

PFISTER®
910-334 • 910-333

Hot/Cold	▲100481
Cold (Lever Only)	▲100482
Bonnet Gasket	128390
O-Ring	128031
Faucet Washer	128451
Bibb Screw	▲128258
Seat (OEM)	131113
Seat	▲120109, 101109
Repair Kit (OEM)	▲131115



Hot / Cold Stems up to 6"

CARDED = 10 (Lincoln) • 13 & 14 (OEM) • **BAGGED** = 68 (OEM) • 11 & 12 (Lincoln) • **BOXED** = 11 (Lincoln).

Broach Not to Scale • Images Are Actual Size

12



PFISTER®
900-006 • 900-007

Ceramic Disc
Hot (OEM) ▲131200
Cold (OEM) ▲131201
Widespread End Bodies
For Thread Down Handle
Assemblies

12



PFISTER®
900-036 • 900-037

Ceramic Disc
Hot (OEM) ▲131204
Cold (OEM) ▲131205
Widespread End Bodies
For Anchored Handle
Assemblies

12

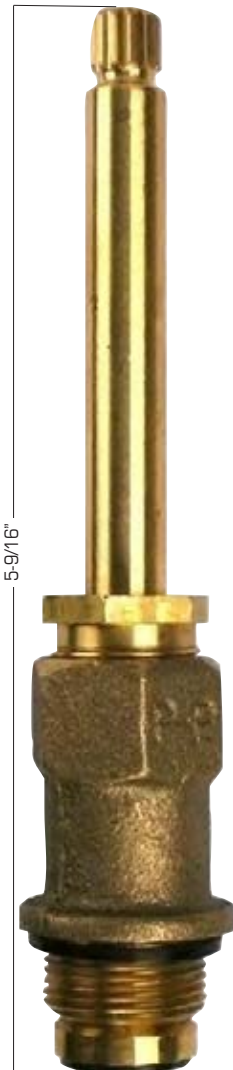

PFISTER®
910-374 • S10-375
Marquis

Hot/Cold (OEM) ▲132411
Hot/Cold w/Seat (OEM) ▲132440
Hot/Cold ▲102461
Renovation Kit ▲111825
Renovation Kit ▲111821
Renovation Kit ▲111874
Renovation Kit ▲111876
Bonnet Gasket 128413
Packing 128342
Faucet Washer 128457
Bibb Screw ▲128258
Seat (OEM) ▲120108, ▲131108
Seat ▲101108
Repair Kit (OEM) 131104



Hot / Cold Stems up to 6"

CARDED = 10 (Lincoln) • 13 & 14 (OEM) • **BAGGED** = 68 (OEM) • 11 & 12 (Lincoln) • **BOXED** = 11 (Lincoln).

Broach Not to Scale • Images Are Actual Size



12

PFISTER®
910-372

- Hot/Cold (OEM) 132341
- Packing 128342
- Faucet Washer 128457
- Bibb Screw ▲128258
- Seat (OEM) ▲120108, ▲131108
- Seat ▲101108
- Repair Kit (OEM) 131104



12

PFISTER®
910-523 • S10-522

- Hot/Cold (OEM) 130487
- Hot/Cold ▲100487
- Bonnet Gasket 128390
- O-Ring 128031
- Faucet Washer 128451
- Bibb Screw ▲128258
- Seat (OEM) 131113
- Seat ▲120109, ▲101109
- Repair Kit (OEM) ▲131115

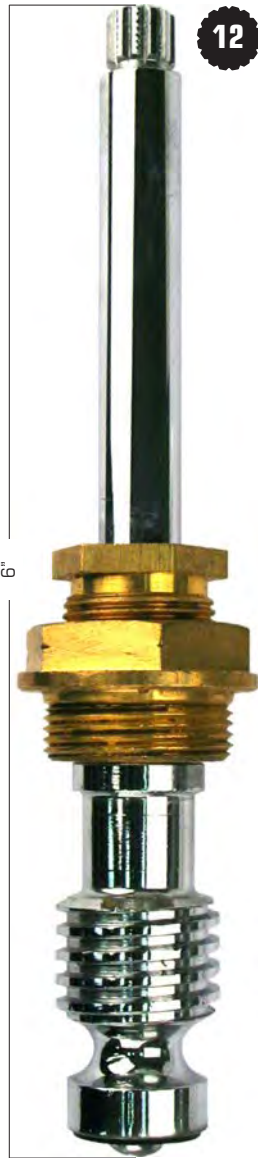

12

REPCAL®

- Hot/Cold Brass Body ▲102362
- Renovation Kit ▲111846

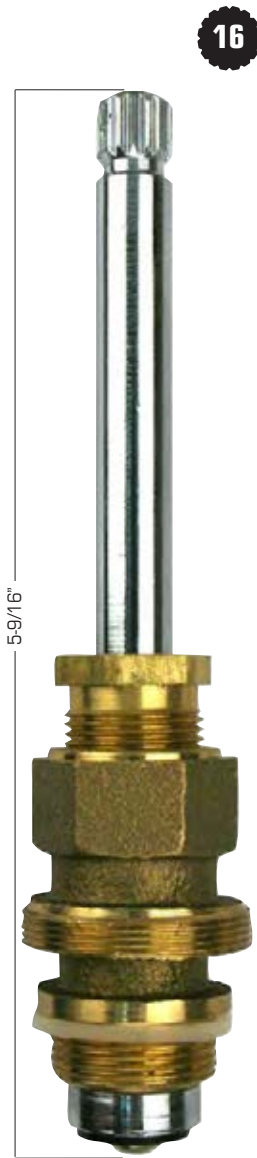

16

STERLING®

- Hot/Cold ▲102422
- Renovation Kit ▲111885
- Renovation Kit ▲111886
- Bonnet Gasket 128413
- Packing 128341
- Faucet Washer 128454
- Bibb Screw ▲128252
- Seat ▲101122, ▲120122



SECTION 5 • PAGE 30

Diverter Stems up to 4"

CARDED = 10 (Lincoln) • 13 & 14 (OEM) • **BAGGED** = 68 (OEM) • 11 & 12 (Lincoln) • **BOXED** = 11 (Lincoln).

 **Broach Not to Scale • Images Are Actual Size**

12

17



3-3/16"

DELTA®
RP10799

Diverter (OEM) ▲132355



3-3/16"

PFISTER®
910-662

Diverter (OEM) ▲132420
Bonnet Gasket 128416
O-Ring 128031
Diverter Washer 128623
Faucet Washer 128457
Bibb Screw ▲128258
Seat (OEM) ▲120108, ▲131108
Seat ▲101108



3-1/8"

PHOENIX®

Diverter 390089
For RV & Mobile Home



2-3/4"

PROFLO™
PF141566PK

Diverter (OEM) ▲141566

SECTION 5 • PAGE 31



Diverter Stems up to 5"

CARDED = 10 (Lincoln) • 13 & 14 (OEM) • BAGGED = 68 (OEM) • 11 & 12 (Lincoln) • BOXED = 11 (Lincoln).

Broach Not to Scale • Images Are Actual Size

SECTION 5 • PAGE 32



BRIGGS®
Trim Line

- Diverter ▲112427
- Renovation Kit ▲111838

PFISTER®
910-022 • S10-022

- Diverter (OEM) ▲132410
- Diverter w/seat (OEM) ▲132445
- Diverter ▲102410
- Bonnet Gasket 128416
- Packing 128342
- Diverter Washer 128623
- Faucet Washer 128457
- Bibb Screw ▲128258
- Seat (OEM) ▲120108, ▲131108
- Seat ▲101108
- Repair Kit (OEM) 131104

SAYCO®

- Diverter ▲102417
- Renovation Kit ▲111875
- Bonnet Gasket 128009
- O-Ring 128007
- Diverter O-Ring 128010
- Faucet Washer 128451
- Bibb Screw ▲128252
- Seat ▲120130

SPEAKMAN®

- Diverter ▲112430

STERLING®

- Diverter ▲102310
- Renovation Kit ▲111871
- Bonnet Gasket 128416
- Packing 128341
- Faucet Washer 128454
- Bibb Screw ▲128252
- Seat ▲101122, ▲120122



Diverter Stems up to 5"

CARDED = 10 (Lincoln) • 13 & 14 (OEM) • BAGGED = 68 (OEM) • 11 & 12 (Lincoln) • BOXED = 11 (Lincoln).

 Broach Not to Scale • Images Are Actual Size

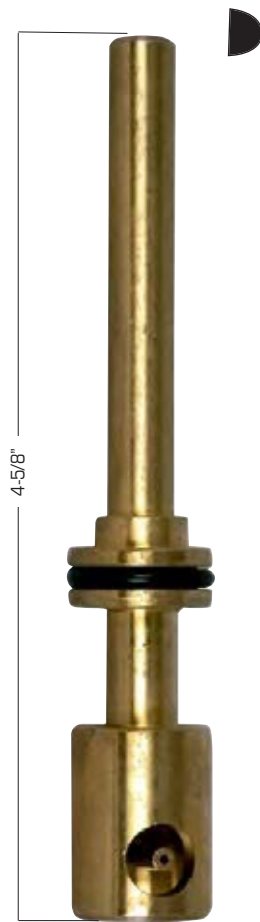

UNION BRASS®

Diverter ▲112431

Diverter Stems up to 6"

CARDED = 10 (Lincoln) • 13 & 14 (OEM) • BAGGED = 68 (OEM) • 11 & 12 (Lincoln) • BOXED = 11 (Lincoln).

Broach Not to Scale • Images Are Actual Size



AMERICAN STANDARD®
Colony

Diverter (OEM) ▲102434
Renovation Kit ▲111833

AMERICAN STANDARD®
009803-0020AP
Tract-Line

Diverter (OEM) 132426
Renovation Kit ▲111829

AMERICAN STANDARD®
Renu

Diverter ▲112425
Renovation Kit ▲111827

GERBER®
98-726 • 98-007

Diverter (OEM) 680913
Diverter w/seat (OEM) 680922
Diverter ▲102436
Renovation Kit ▲111879

MILWAUKEE®

Diverter ▲112432



Diverter Stems up to 6"

CARDED = 10 (Lincoln) • 13 & 14 (OEM) • **BAGGED** = 68 (OEM) • 11 & 12 (Lincoln) • **BOXED** = 11 (Lincoln).

Broach Not to Scale • Images Are Actual Size

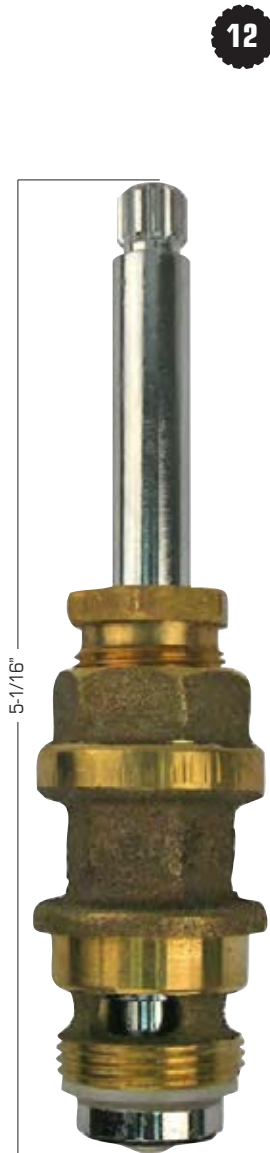

PFISTER®
910-052

- Diverter ▲102404
- Bonnet Gasket 128416
- Packing 128342
- Diverter Washer 128623
- Faucet Washer 128457
- Bibb Screw ▲128258
- Seat (OEM) ▲120108, ▲131108
- Seat ▲101108
- Repair Kit (OEM) 131104

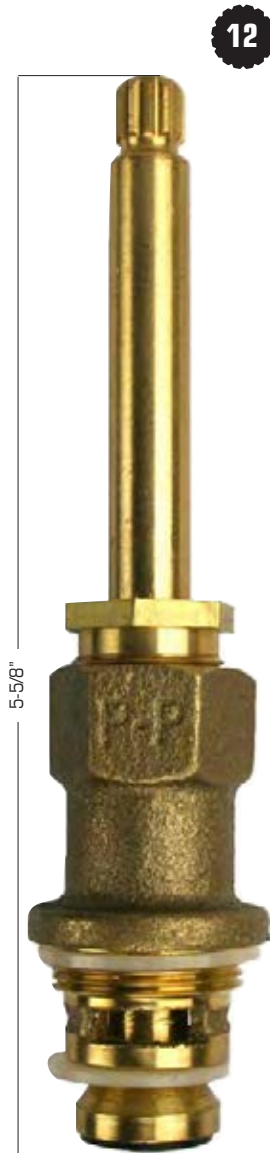

PFISTER®
910-385 • S10-385

- Diverter (OEM) ▲132412
- Diverter w/Seat (OEM) ▲132441
- Diverter ▲102462
- Renovation Kit ▲111821
- Renovation Kit * ▲111876
- Bonnet Gasket 128416
- Packing 128342
- Diverter Washer 128623
- Faucet Washer 128457
- Bibb Screw ▲128258
- Seat (OEM) ▲120108, ▲131108
- Seat ▲101108
- Repair Kit (OEM) 131104

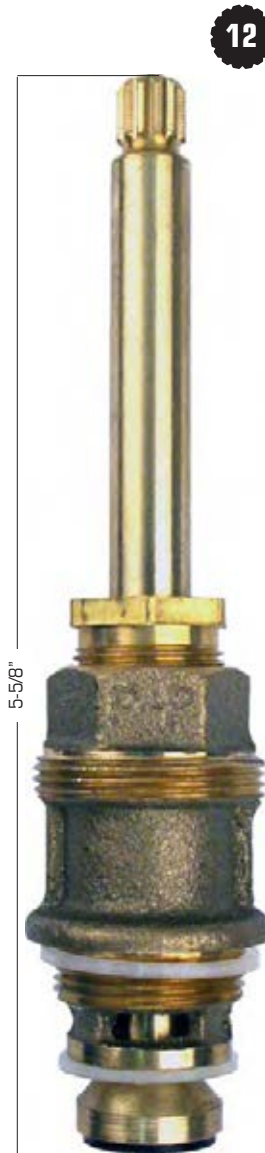

PFISTER®
910-382

- Diverter (OEM) 132342
- Bonnet Gasket 128416
- Packing 128342
- Diverter Washer 128623
- Faucet Washer 128457
- Bibb Screw ▲128258
- Seat (OEM) ▲120108, ▲131108
- Seat ▲101108
- Repair Kit (OEM) 131104

SECTION 5 • PAGE 35



Single Control Cartridges

CARDED = 10 (Lincoln) • 13 & 14 (OEM) • BAGGED = 68 (OEM) • 11 & 12 (Lincoln) • BOXED = 11 (Lincoln).

Images Are Actual Size



AMERICAN STANDARD®
066269-0070AP
Ultramix™
Cartridge (OEM) 131520
Bath/Shower - 1363 Series
With Screws



AMERICAN STANDARD®
A951470-0070AP
Ceramic Disc
40mm Cartridge (OEM) 131521
Volume & Temperature
Control



AMERICAN STANDARD®
023529-0070AP
Ceramic Disc
47mm Cartridge (OEM) 131522



AMERICAN STANDARD®
M952100-0070AP
Pressure Balance
Unit (OEM) 131530
Bath/Shower



Single Control Cartridges

CARDED = 10 (Lincoln) • 13 & 14 (OEM) • **BAGGED** = 68 (OEM) • 11 & 12 (Lincoln) • **BOXED** = 11 (Lincoln).

Images Are Actual Size

12



AMERICAN STANDARD®
A954440-0070AP
Ceramic Disc
40mm Cartridge (OEM) 131531
Volume & Temperature
Control



CHICAGO®
665-190KJKABNF
MVP™ Metering Valve
Actuator (OEM) ▲131564



CHICAGO®
671-XJKABNF
MVP™ Metering Valve
Cartridge (OEM) ▲131566
With Screen & Washer



CHICAGO®
667-080KJKPABNF
MVP™ Metering Valve
Cartridge & Actuator ▲131569



CHICAGO®
665-RKPABCP
MVP™ Metering Valve
Cartridge & Actuator
With Push Handle ▲131594



DELTA®
RP70
Ball (OEM) 111145, 131145
Ball (OEM) 6PK 119919
Repair Kit (OEM) 131193



DELTA®/PEERLESS®
RP212
Ball (OEM) ▲111146, ▲131146
Ball (OEM) 6PK ▲119911
Repair Kit (OEM) 131133
Repair Kit (OEM) ▲131196

SECTION 5 • PAGE 37



Single Control Cartridges

CARDED = 10 (Lincoln) • 13 & 14 (OEM) • BAGGED = 68 (OEM) • 11 & 12 (Lincoln) • BOXED = 11 (Lincoln).

Images Are Actual Size



DELTA®
RP32104
Monitor®
Cartridge (OEM) 131733
For Tub & Shower Valves
17 Series



DELTA®
RP19804
Pressure Balance
Cartridge (OEM) ▲131741
For 1300 / 1400 Series



ADAPTER



DELTA®
RP574
Pressure Balance
Spool (OEM) ▲131745
For 600/1600 Series



DELTA®
RP46463
Pressure Balance
Cartridge (OEM) 131746
Universal w/adapter • For 1700/800 Series



Single Control Cartridges

CARDED = 10 (Lincoln) • 13 & 14 (OEM) • **BAGGED** = 68 (OEM) • 11 & 12 (Lincoln) • **BOXED** = 11 (Lincoln).

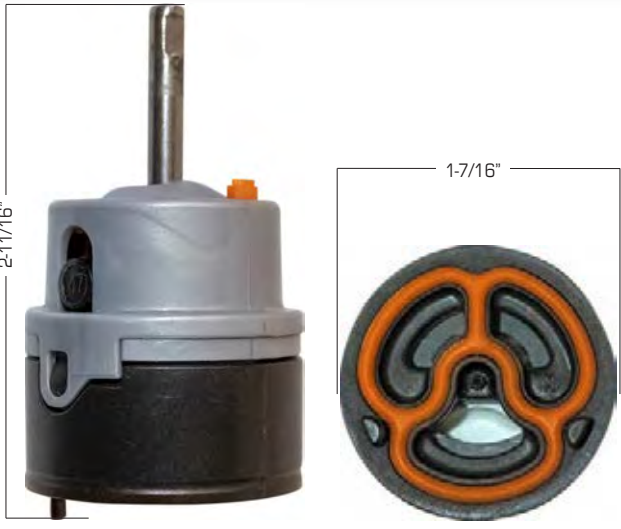

DELTA®
RP50587
Cartridge (OEM) 131748



Images Are Actual Size

DELTA®
RP46074
Pressure Balance
Cartridge (OEM) ▲131749
For 1300/1400 Series



GERBER
Ceramic Disc
40mm Cartridge ▲101660
With Temperature Limit Stop



GERBER
97-014
Safetemp Pressure Balance
Cartridge (OEM) 680905

SECTION 5 • PAGE 39



Single Control Cartridges

CARDED = 10 (Lincoln) • 13 & 14 (OEM) • BAGGED = 68 (OEM) • 11 & 12 (Lincoln) • BOXED = 11 (Lincoln).

Images Are Actual Size



GERBER
97-022
Safetemp
Cartridge (OEM) 680906



GERBER
92-298
Ceramic Disc
Cartridge (OEM) 680909



GERBER
97-232
Pressure Balance
Cartridge (OEM) 680927



GERBER
98-736
Cartridge (OEM) 680928
With Bottom Seal



Single Control Cartridges

CARDED = 10 (Lincoln) • 13 & 14 (OEM) • **BAGGED** = 68 (OEM) • 11 & 12 (Lincoln) • **BOXED** = 11 (Lincoln).

Images Are Actual Size



GLACIER BAY

Ceramic Disc
40mm Cartridge ▲101655
With Temperature Limit Stop



GLACIER BAY

Pressure Balance
Ceramic Disc
40mm Cartridge ▲101656
With Temperature Limit Stop

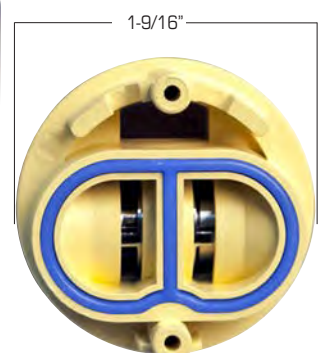

GLACIER BAY/SEASONS

Pressure Balance
Ceramic Disc
Cartridge ▲101657
With Temperature Limit Stop



▲ For **Proposition 65** warnings please refer to pages 93-124 at the end of this section.

All Products Used for Potable Water are:



Single Control Cartridges

CARDED = 10 (Lincoln) • 13 & 14 (OEM) • BAGGED = 68 (OEM) • 11 & 12 (Lincoln) • BOXED = 11 (Lincoln).

Images Are Actual Size



KOHLER®
GP1017426
Ceramic Disc
Cartridge (OEM) 130347

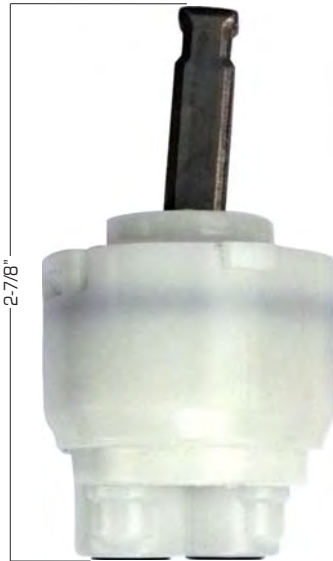

KOHLER®
GP30413
Coralais
Cartridge (OEM)
Older Style 131279



KOHLER®
GP1016515
Ceramic Disc
Cartridge (OEM) 131702
For Forte, Evoke, Vanata,
Clairette, Bol, & Vas faucets



KOHLER®
GP71969
Cartridge (OEM)
Coralais® Mixer Kit
Bath & Shower 131779



Single Control Cartridges

CARDED = 10 (Lincoln) • 13 & 14 (OEM) • BAGGED = 68 (OEM) • 11 & 12 (Lincoln) • BOXED = 11 (Lincoln).



KOHLER®
GP77759

Mixer Cap Kit (OEM) 131783
For K-304 Rite-Temp Valve

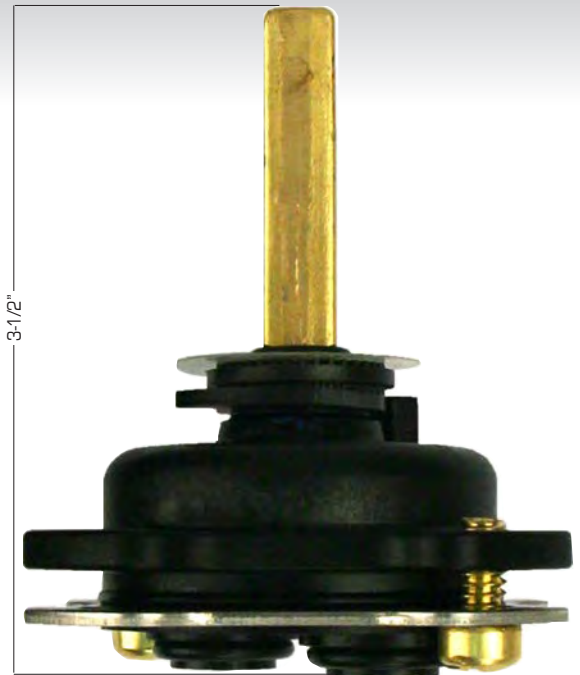

KOHLER®
GP77886

Mixer Cap Kit (OEM) 131785
Coralais® Bath & Shower

KOHLER®
GP876851

Pressure Balance
Cap & Cartridge
Combo (OEM) ▲ 131704
Includes: GP800820
& GP77759
For Rite-Temp Bath & Shower



KOHLER®
GP800820

Pressure Balance
Unit Valve (OEM) 131703
For Rite-Temp Bath & Shower
Retrofit Use in place of old GP500520



KOHLER®
GP77548

Ceramic Disc
Cartridge (OEM) 132357
Avatar®, Fairfax®, Coralais®
Lavatory & Kitchen



Single Control Cartridges

CARDED = 10 (Lincoln) • 13 & 14 (OEM) • BAGGED = 68 (OEM) • 11 & 12 (Lincoln) • BOXED = 11 (Lincoln).

Images Are Actual Size



KOHLER®
GP1144925

Pressure Balance
Cartridge (OEM) 132901
For 3/4" High Flow
Pressure Balance
Valve



KOHLER®
GP800881

Pressure Balance
Cartridge (OEM) ▲132912
For 1/2" RiteTemp



KOHLER®
GP1093674

Ceramic Disc
25mm Cartridge (OEM) 132903



Single Control Cartridges

CARDED = 10 (Lincoln) • 13 & 14 (OEM) • BAGGED = 68 (OEM) • 11 & 12 (Lincoln) • BOXED = 11 (Lincoln).

Images Are Actual Size



6-1/4"

MIXET®
MS3T

Before 1968
Cartridge "Generic" ▲132320
#3A



4-1/2"

MIXET®
MS5AT

After 1968
Cartridge "Generic" ▲132321
#5A

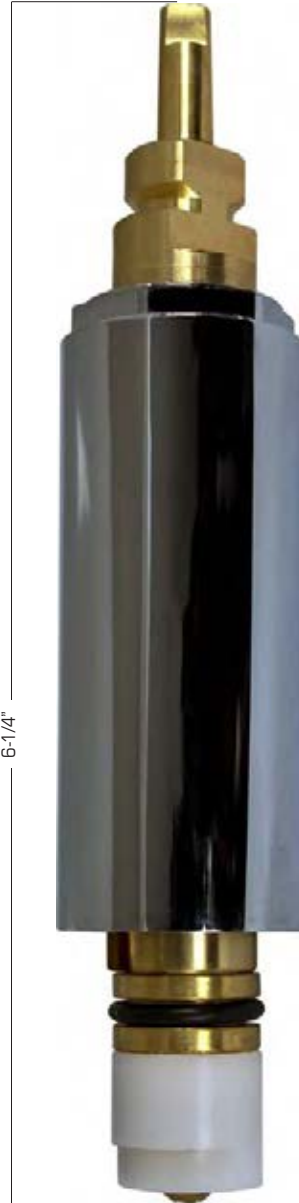

6-1/4"

MIXET®
MMSA-EXT

Before 1968
Cartridge "Generic" ▲112322



4-1/4"

MOEN®
1200

Brass
Cartridge (OEM) ▲132306
Cartridge ▲102306
Cartridge 5PK ▲110126



Single Control Cartridges

CARDED = 10 (Lincoln) • 13 & 14 (OEM) • BAGGED = 68 (OEM) • 11 & 12 (Lincoln) • BOXED = 11 (Lincoln).

Images Are Actual Size



MOEN®
1255
Duralast
Cartridge (OEM) 132308



MOEN®
4000
Xerox
Ceramic Disc
Cartridge (OEM) 132316
CA, 7100, 7106
& 7175 Series



MOEN®
1225
Plastic
Cartridge (OEM) ▲132307
Cartridge (OEM) ▲119925
Cartridge ▲102313
Cartridge 2PK ▲110123



MOEN®
1222
Posi-Temp
Cartridge (OEM) ▲132314
Cartridge (OEM) ▲119922
Cartridge ▲102314



MOEN®
1423
Moentrol
Spool (OEM) ▲132343
Tub & Shower Valves



Single Control Cartridges

CARDED = 10 (Lincoln) • 13 & 14 (OEM) • BAGGED = 68 (OEM) • 11 & 12 (Lincoln) • BOXED = 11 (Lincoln).

Images Are Actual Size

PFISTER®
970-045
Ball (OEM) 131103
With Seats & Springs



PFISTER®
S74-570
Genesis
Ceramic Disc
Cartridge (OEM) 131252



PFISTER®
900-022
Flow-Matic
Cartridge ▲111755



PFISTER®
974-044
Ceramic Disc
35mm Cartridge (OEM) 131253
For Pfirst Series & Classic
Collection



PFISTER®
974-321
JX8
Ceramic Disc
Cartridge (OEM) 131764



Single Control Cartridges

CARDED = 10 (Lincoln) • 13 & 14 (OEM) • BAGGED = 68 (OEM) • 11 & 12 (Lincoln) • BOXED = 11 (Lincoln).

Images Are Actual Size



PFISTER®
974-042
Ceramic Disc
Cartridge (OEM) 131765



PFISTER®
974-074
Ceramic Disc
25mm Cartridge (OEM) 131771
529 Series Kitchen Single Lever



PFISTER®
S74-291
Pressure Balance
Cartridge (OEM) 131770



PFISTER®
S74-292
Avante
Ceramic Disc
Cartridge (OEM) 112315
Cartridge (OEM) 132315
Cartridge ▲102315



PFISTER®
974-250
Ceramic Disc
35mm Cartridge (OEM) 131772



PFISTER®
971-250
Stem Assembly (OEM) 131776



Single Control Cartridges

CARDED = 10 (Lincoln) • 13 & 14 (OEM) • **BAGGED** = 68 (OEM) • 11 & 12 (Lincoln) • **BOXED** = 11 (Lincoln).

Images Are Actual Size



PROFLO™
PF141555PK

Ceramic Disc
Cartridge (OEM) 141555
Kitchen, Lavatory



PROFLO™
PF141558PK

Ceramic Disc
Cartridge (OEM) 141558
For 51/9091-9293 Tub/Shower
Includes Pressure Balance
Module



PROFLO™
PFX141564PK

Ceramic Disc
35mm Cartridge (OEM) 141564
Kitchen, Lavatory

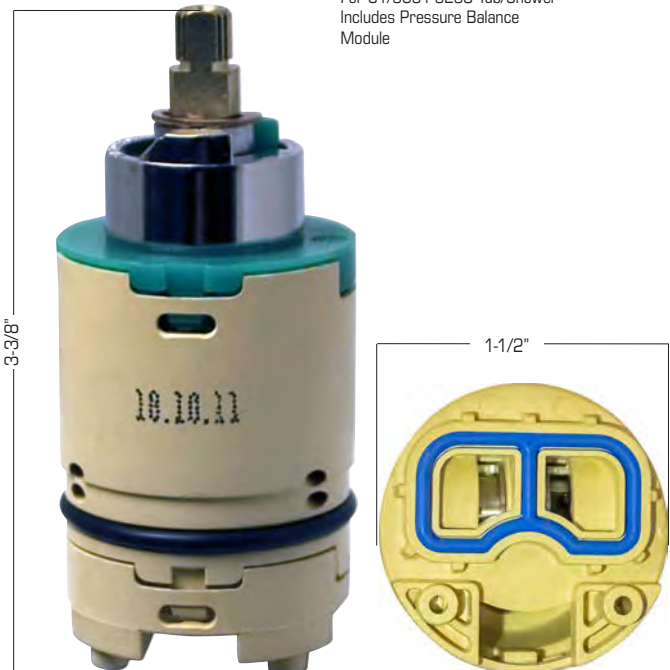

PROFLO™
ACF3001CRT
ACCUFIT™

Ceramic Disc
Cartridge (OEM) ▲141596



Single Control Cartridges

CARDED = 10 (Lincoln) • 13 & 14 (OEM) • BAGGED = 68 (OEM) • 11 & 12 (Lincoln) • BOXED = 11 (Lincoln).

Images Are Actual Size

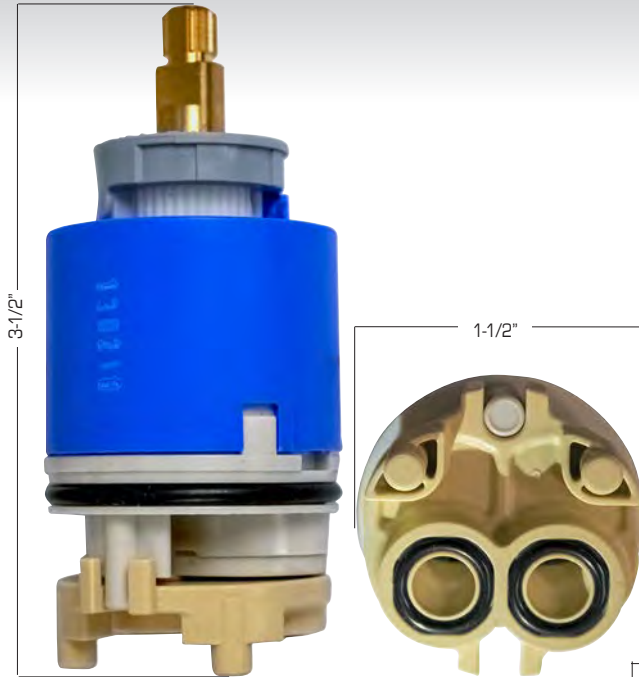

PROFLO™
ACF3001CRT2
ACCUFIT™

Ceramic Disc
Cartridge (OEM) ▲141598
With Spacer

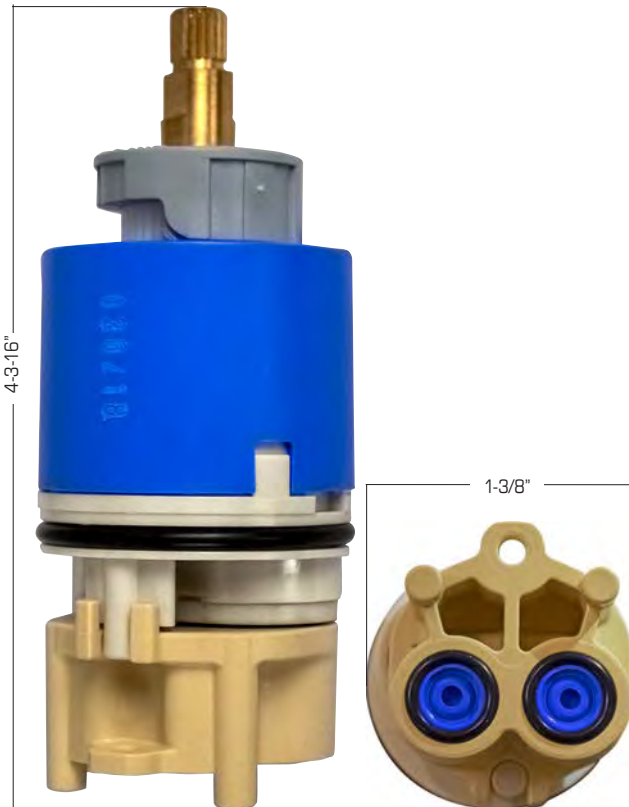

PROFLO™
ACF4001UCRT
ACCUFIT™

Ceramic Disc
Cartridge (OEM) ▲141599
Check Valve & Spacer

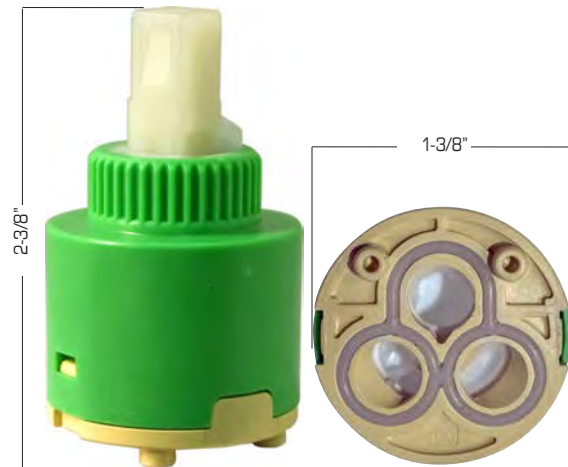

PROFLO™
PF141715PK

Ceramic Disc
Cartridge (OEM) 141715
For PFWS7840 Faucets



SECTION 5 • PAGE 50

Single Control Cartridges

CARDED = 10 (Lincoln) • 13 & 14 (OEM) • **BAGGED** = 68 (OEM) • 11 & 12 (Lincoln) • **BOXED** = 11 (Lincoln).

Images Are Actual Size



TEMPRESS II

Pressure Balance
Cartridge ▲102355
Stop Repair Kit ▲102356



T&S BRASS
238AB

Metering Valve
Cartridge (OEM) ▲680793
With Push Handle



T&S BRASS
013111-45

Ceramic Disc
Cartridge (OEM) ▲680819
B-2710 & B-2711

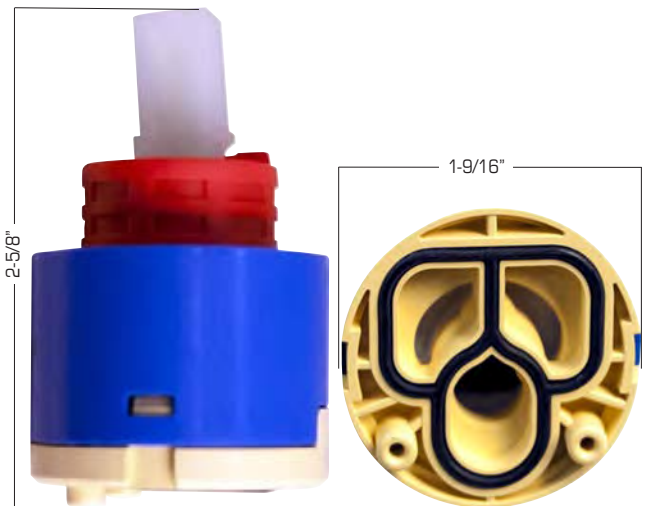

SYMMONS®

Ceramic Disc
40mm Cartridge ▲101651
With Temperature Limit Stop



Single Control Cartridges

CARDED = 10 (Lincoln) • 13 & 14 (OEM) • BAGGED = 68 (OEM) • 11 & 12 (Lincoln) • BOXED = 11 (Lincoln).

Images Are Actual Size

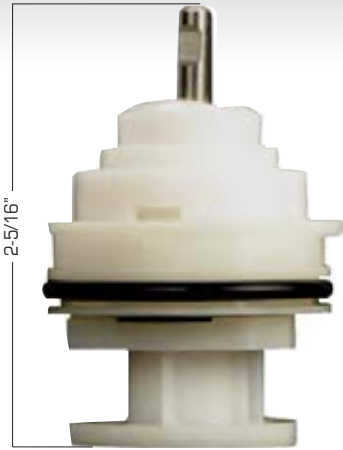

VALLEY®

Cartridge 101226
Volume & Temperature Control



VALLEY®

Pressure Balance Cartridge ▲111230



ZURN®

Ceramic Disc
40mm Cartridge ▲101650
With Temperature Limit Stop



Faucet Seats

CARDED = 10 (Lincoln) • 13 & 14 (OEM) • **BAGGED** = 68 (OEM) • 11 & 12 (Lincoln) • **BOXED** = 11 (Lincoln).

Images Are Actual Size

<p>AMERICAN STANDARD®</p> <p>SIZE: 7/16"-24 LENGTH: 11/32"</p>  <p>GENERIC ▲120148</p>	<p>AMERICAN STANDARD® 000862-1400AP</p> <p>SIZE: 7/16"-24 LENGTH: 13/32"</p>  <p>OEM ▲131102</p> <p>GENERIC ▲101145</p>	<p>AMERICAN STANDARD®</p> <p>SIZE: 1/2"-20 LENGTH: 7/16"</p>  <p>GENERIC ▲101150 ▲120150</p>	<p>AMERICAN STANDARD® TRACT STYLE</p> <p>SIZE: 9/16"-18 LENGTH: 3/8"</p>  <p>GENERIC ▲120146</p>
<p>AMERICAN STANDARD®</p> <p>SIZE: 9/16"-24 LENGTH: 3/8"</p>  <p>GENERIC ▲120152</p>	<p>ARROWHEAD</p> <p>SIZE: 1/2"-20 LENGTH: 5/16"</p>  <p>GENERIC ▲120149</p>	<p>GERBER NEW STYLE</p> <p>SIZE: 5/8"-20 LENGTH: 27/64"</p>  <p>GENERIC ▲101155 ▲120155</p>	<p>KOHLER®</p> <p>SIZE: 1/2"-27 LENGTH: 5/16"</p>  <p>GENERIC ▲120151</p>
<p>KOHLER®</p> <p>SIZE: 1/2"-27 LENGTH: 3/8"</p>  <p>GENERIC ▲120129</p>	<p>PFISTER® S70-510 • 970-510</p> <p>SIZE: 1/2"-20 LENGTH: 11/32"</p>  <p>OEM 131113 131199 24PK</p> <p>GENERIC ▲101109 ▲120109</p>	<p>PFISTER® S70-500 • 970-500</p> <p>SIZE: 31/32"-18 LENGTH: 3/8"</p>  <p>OEM ▲131108 ▲131197 24PK ▲120108</p> <p>GENERIC ▲101108</p>	<p>PFISTER®</p> <p>SIZE: 21/32"-18 LENGTH: 1-9/16"</p>  <p>GENERIC ▲101180</p>
<p>SAYCO®</p> <p>SIZE: 1/2"-20 LENGTH: 5/16"</p>  <p>GENERIC ▲120130</p>	<p>STERLING®/MIDCOR®</p> <p>SIZE: 1/2"-24 LENGTH: 3/8"</p>  <p>GENERIC ▲101122 ▲120122</p>	<p>STREAMWAY®</p> <p>SIZE: 1/2"-27 LENGTH: 1-7/32"</p>  <p>GENERIC ▲120154</p>	<p>T&S BRASS 000788-20M • 000789-20M</p>  <p>OEM ▲680811 (hot) ▲680812 (cold)</p>



Delta® Stem Extension

Fits two handle tub and shower valves. With screw.

STOCK#	PACK	CASE	DESCRIPTION	MFG#	UPC#
132319	6	72	STEM EXTENSION	RP18627	054374105793



Moen® Stem Extension Kits

Stem extension for two handle tub and shower valves.

STOCK#	PACK	CASE	DESCRIPTION	MFG#	UPC#
131525	6	144	STEM EXTENSION	13599	054374116423



Sleeve and 1" handle extension kit for 2200, 2400, 2600 and 2700 models.

131523	6	72	CHROME PLATED	10399	054374126002
--------	---	----	---------------	-------	--------------

Sleeve and 1" handle extension kit for single handle shower valves.

131524	6	48	CHROME PLATED	96945	054374123148
--------	---	----	---------------	-------	--------------



Pfister® Stem Extensions

1" extension for two and three valve showers. Includes two screws to adapt to new and old style handles.

STOCK#	PACK	CASE	DESCRIPTION	MFG#	UPC#
132407	6	144	SHOWER STEM EXTENSION	S10-561	054374094691



For "New Style" Verve or Windsor handles. Extends stems that use threaded flanges 1".

132408▲	6	144	NEW STYLE STEM EXTENSION	910-862	054374113132
---------	---	-----	--------------------------	---------	--------------

Fit-All Faucet Handles

A full selection of handles are available for shower, bath and kitchen faucets.

Fit-All Faucet Handles

Fit-all handles: Distinctively styled Lincoln replacement handles come in a variety of chrome and acrylic shapes and sizes. All handles are designed to be used with a triple point adapter or fit-all broach which is included in each package. The unique triple point contact provides superior locking onto any stem, regardless of its configuration, size or damaged condition and eliminates the need to sell separate adapters.

Vise-Grip Style Lever Handles - Pair

Includes 2 handles with hex wrench and locking jaw adapters.

STOCK#	PK	CS	DESCRIPTION	MFG#	UPC#
101482▲	6	72	HOT & COLD	2 PER CARD	054374105533

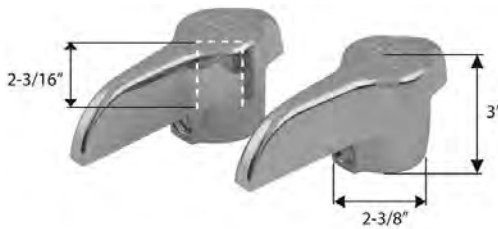

Vise-Grip Style Lucite Handles - Pair

Includes 2 handles with hex wrench and locking jaw adapters.

STOCK#	PK	CS	DESCRIPTION	MFG#	UPC#
101484▲	6	36	HOT & COLD	2 PER CARD	054374105557

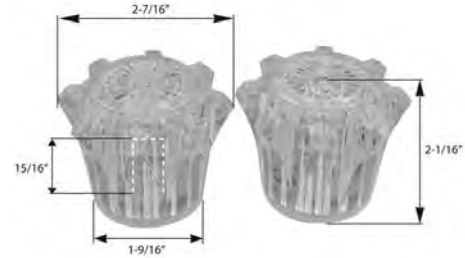

Vise-Grip Style Cross Handles - Pair

Includes 2 handles with hex wrench and locking jaw adapters.

STOCK#	PK	CS	DESCRIPTION	MFG#	UPC#
101483▲	6	72	HOT & COLD	2 PER CARD	054374105540



Porcelain

STOCK#	PK	CS	DESCRIPTION	MFG#	UPC#
101494▲	6		CROSS HANDLE - CP		054374121826
101496▲	6		LEVER HANDLE - CP		054374121830

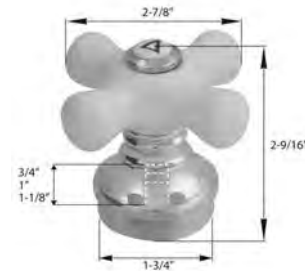

Metal Handles - Pair

STOCK#	PK	CS	DESCRIPTION	MFG#	UPC#
101430▲	6	72	CHROME STAR CANOPY 2 PER CARD	054374004409	
101432▲	6	72	CHROME CROSS	2 PER CARD	054374004423
101433▲	6	72	CHROME LEVER CANOPY 2 PER CARD	054374004430	



Lever Handle - Pair

STOCK#	PK	CS	DESCRIPTION	MFG#	UPC#
101431▲	6	72	CHROME PLATED	2 PER CARD	054374095094



▲ For Proposition 65 warnings please refer to pages 93-124 at the end of this section.

All Products Used for Potable Water are:



Fit-All Faucet and Replacement Handles

Lucite Adjustable Handles - Pair

This handle has a removable skirt that provides height adjustment to fit a variety of faucets.

STOCK#	PK	CS	DESCRIPTION	MFG#	UPC#
101434▲	6	36	CLEAR	2 PER CARD	054374004447

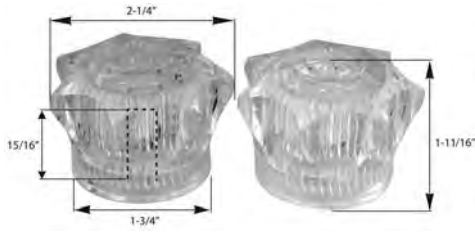

Deluxe Lucite Handles

STOCK#	PK	CS	DESCRIPTION	MFG#	UPC#
101436▲	6		CLEAR - LARGE	2 PER CARD	054374004461
101437▲	6	36	CLEAR - DIVERTER	1 PER CARD	054374004478



Chrome Plated Handles

Metal - Large.

STOCK#	PK	CS	DESCRIPTION	MFG#	UPC#
101486▲	6		HOT & COLD	2 PER CARD	054374105571
101487▲	6	36	DIVERTER	1 PER CARD	054374105588

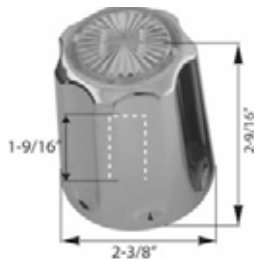

Handicap 4" Blade Handles - Pair

STOCK#	PK	CS	DESCRIPTION	MFG#	UPC#
101480	6	72	CHROME PLATED	2 PER CARD	054374105526
111480	1	12	CHROME PLATED PROFESSIONAL PACK	2 PER BAG	054374387120

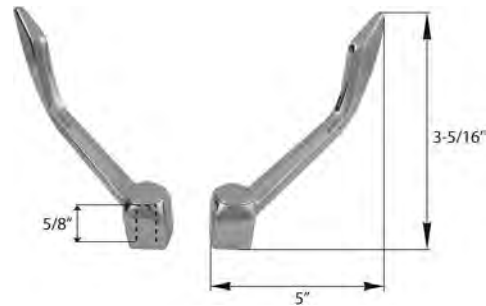

Replacement Handles

All handles include screws and buttons where applicable.

American Standard®

Fits American Standard® kitchen / bath faucets.

STOCK#	PK	CS	DESCRIPTION	MFG#	UPC#
101335	6	72	HOT SIDE		054374073504
101385	6	72	COLD SIDE		054374073511

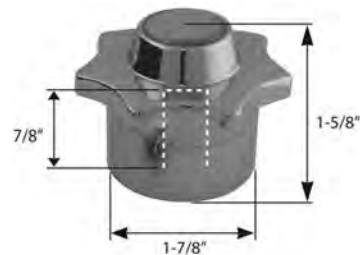

Replacement Handles

All handles include screws and buttons where applicable.

Delta®

The popularity and demand for its complete line of kitchen, bath and lavatory and tub and shower faucets is primarily the result of unexcelled, washerless design that virtually eliminates the source of annoying drips, expensive repairs and replacement. But for those replacements we have the right part to fit your faucet.

Delta® Single Control Lucite Handle

Fits Delta® showers and centersets. Includes screw.

Genuine manufacturer repair part.

STOCK#	PK	CS	DESCRIPTION	MFG#	UPC#
131414	6	36	SHOWER	RP17451	054374094165
131418	6	48	LAVATORY	RP17449	054374094196
131469	6	48	SHOWER	RH71	054374108046

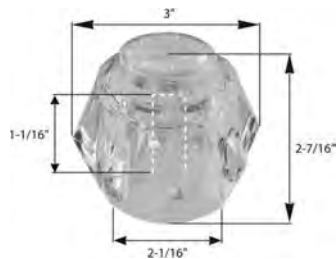

Delta® Twin Acrylic Handle

Fits Delta® twin handle kitchen and lavatory faucets. Includes screw.

Genuine manufacturer repair part.

STOCK#	PK	CS	DESCRIPTION	MFG#	UPC#
131497	6		HOT & COLD	RP23498	054374116515

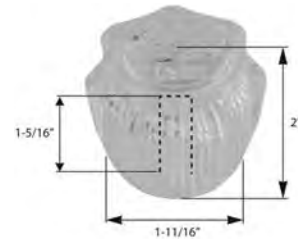

Delta® Lever Handle

Fits Delta® showers, kitchen deck faucets and centersets. Includes screw.

Genuine manufacturer repair part.

STOCK#	PK	CS	DESCRIPTION	MFG#	UPC#
131417	6	48	LEVER CHROME	RP2393	054374094189

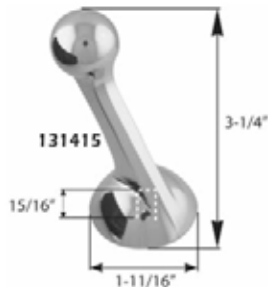

Delta® New Style Lever Handle

Fits Delta® showers, kitchen deck faucets and centersets. Includes screw.

Genuine manufacturer repair part.

STOCK#	PK	CS	DESCRIPTION	MFG#	UPC#
131470	6	48	LAV. & SHOWER	RP17443	054374108053



Delta® Single Control Acrylic Handle

Fits Delta® old style tub/shower faucets. Includes screw.

Genuine manufacturer repair part.

STOCK#	PK	CS	DESCRIPTION	MFG#	UPC#
131473	6	48	TUB & SHOWER	RP2391	054374112241

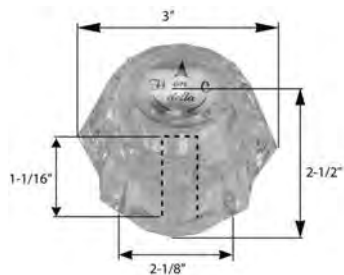

Delta® Twin Acrylic Handle

Fits Delta® twin handle widespread or tub/shower valves.

Includes screws. Genuine manufacturer repair part.

STOCK#	PK	CS	DESCRIPTION	MFG#	UPC#
131481	6		HOT & COLD	H41A	054374116171



▲ For Proposition 65 warnings please refer to pages 93-124 at the end of this section.

All Products Used for Potable Water are:



All handles include screws and buttons where applicable.

Harcraft®

Fits Harcraft® widespread faucets and shower valves.
Hot, cold and diverter buttons included.

STOCK#	PK	CS	DESCRIPTION	MFG#	UPC#
101493▲	6	48	HOT, COLD OR DIVERTER - LARGE	054374061150	



Kohler®

Genuine manufacturer repair part.

STOCK#	PK	CS	DESCRIPTION	MFG#	UPC#
131786	3	63	TREND BATH- CP	GP21087CP	650531631039



Mixet®

Fits Mixet® Tub/Shower Faucets. Includes screw.

STOCK#	PK	CS	DESCRIPTION	MFG#	UPC#
131410	6	72	LEVER - SMOKE	MTH-SMK	054374094141
131426	6	72	LEVER - CLEAR ACRYLIC	MTH-CLR	054374094226

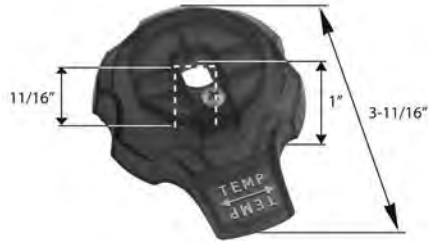

Mixet®

Fits Mixet® Tub/Shower Faucets. Includes screw.

STOCK#	PK	CS	DESCRIPTION	MFG#	UPC#
131411	6	72	ROUND - SMOKE ACRYLIC	MRH-SMK	054374094158
131425	6	72	ROUND - CLEAR ACRYLIC	MRH-CLR	054374094219
131427▲	6	72	ROUND - CP METAL	MRH-MET	054374094233

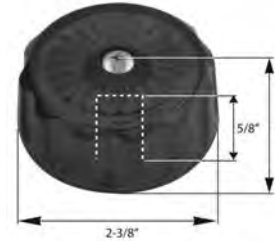

Mixet®

Fits Mixet® Tub/Shower Faucets. Chrome plated button.

STOCK#	PK	CS	DESCRIPTION	MFG#	UPC#
131464	6	36	DELUXE ACRYLIC	MDX-RH	054374113569

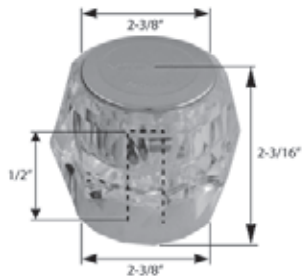

Mixet®

Fits Mixet® Tub/Shower Faucets. Includes screw.

STOCK#	PK	CS	DESCRIPTION	MFG#	UPC#
131423▲	12		LEVER - CP METAL	MLH-MET	054374107858
131424	12		LEVER - CP PLASTIC	MLH-CP	054374094202



SECTION 5 • PAGE 58

Replacement Handles

All handles include screws and buttons where applicable.

Mixet®

Fits Mixet® Tub/Shower Faucets. Includes: Temperature control lever handle (metal) and volume control round handle (clear acrylic).

STOCK#	PK	CS	DESCRIPTION	MFG#	UPC#
131422	1	6	TEMPERATURE & VOLUME CONTROL	MXT-14	054374384648



Mixet®

Fits Mixet® Tub/Shower Faucets. Includes: Smoked acrylic temperature control lever handle and volume control round handle.

STOCK#	PK	CS	DESCRIPTION	MFG#	UPC#
131430	1	6	TEMPERATURE & VOLUME CONTROL-SMOKE		054374243846



Moen®

Fits Moen® Legend faucets only. Includes screw. Fits Legend Shower Faucets.

STOCK#	PK	CS	DESCRIPTION	MFG#	UPC#
101479	6	48	GENERIC - TUB & SHOWER		054374106189

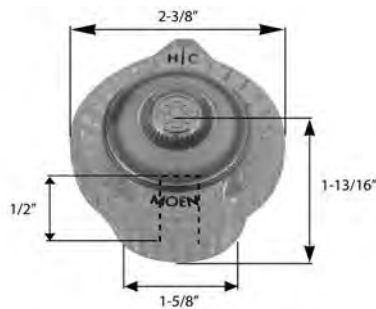

Moen®

Fits Moen® Chateau faucets only. Includes screw.

STOCK#	PK	CS	DESCRIPTION	MFG#	UPC#
131448	6	48	GENUINE - LAVATORY	M96791	054374094332
101476▲	6	48	GENERIC - LAVATORY		054374106158

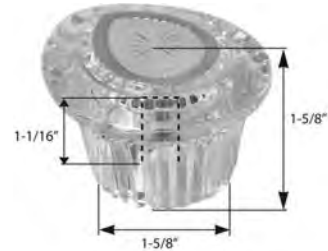

Moen®

Fits Moen® Chateau Faucets only.

STOCK#	PK	CS	DESCRIPTION	MFG#	UPC#
131449	6	48	GENUINE - SHOWER	M96797	054374094349
101477▲	6	48	GENERIC TUB & SHOWER		054374106165

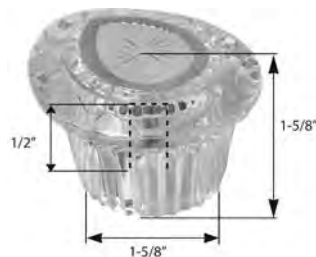

Moen®

Handle cap kit fits Moen® Chateau "One-Touch" kitchen and lavatory faucets.

STOCK#	PK	CS	DESCRIPTION	MFG#	UPC#
131467	6	48	GENUINE - KITCHEN	M96790	054374123155



Replacement Handles

All handles include screws and buttons where applicable.

Moen®

Fits Moen® Positemp Tub/shower valves. Includes screw.

STOCK#	PK	CS	DESCRIPTION	MFG#	UPC#
131474	6	48	GENUINE	M94514/91751	054374123155
101474	6	48	GENERIC		054374411450



Posi - Temp Handle

Fits Moen® Touch Control lavatory faucets. Includes screw.

STOCK#	PK	CS	DESCRIPTION	MFG#	UPC#
131475	6	48	GENUINE	M92504	054374123315

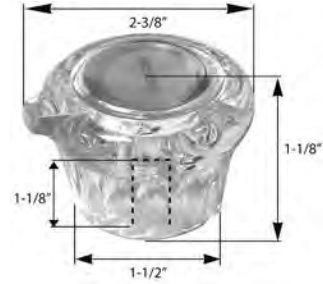

Monogram Brass® Clear Acrylic

Contains handle, screw and button for Monogram Brass® and most Asian import kitchen, lavatory, tub/shower faucets.

STOCK#	PK	CS	DESCRIPTION	MFG#	UPC#
101342	6	48	HOT		054374105328
101392	6	48	COLD		054374105465
101354	6	48	HOT, COLD & DIV BUTTONS		054374105458

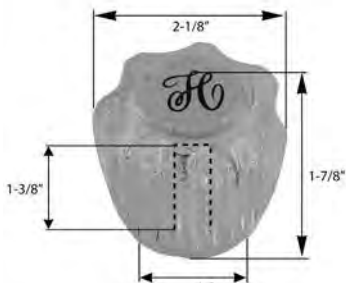

Pfister® "Crown Jewel"

Small.

STOCK#	PK	CS	DESCRIPTION	MFG#	UPC#
131300	6	144	HOT-GENUINE	940-220	054374042371
131351	6	144	COLD-GENUINE	940-526A	054374989683



Pfister®

Fits Mobile Home tub and shower valves. Includes three buttons.

STOCK#	PK	CS	DESCRIPTION	MFG#	UPC#
101409▲	6	48	HOT,COLD OR DIVERTER		054374087020

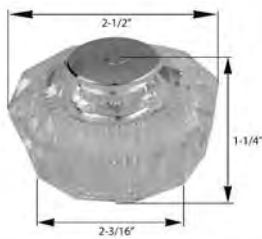

Pfister® "Contempra"

Large.

STOCK#	PK	CS	DESCRIPTION	MFG#	UPC#
101403▲	6	48	HOT-GENERIC		054374004201
101443▲	6	48	DIVERTER-GENERIC		054374004539
101453▲	6	48	COLD-GENERIC		054374004607



SECTION 5 • PAGE 60

Replacement Handles

All handles include screws and buttons where applicable.

Pfister® "Verve"

Large.

STOCK#	PK	CS	DESCRIPTION	MFG#	UPC#
131405	6	48	HOT-GENUINE	940-510A	054374094103
101405▲	6	48	HOT-GENERIC		054374004225
131445	6	48	DIVERTER-GENUINE	940-510A	054374094301
101445▲	6	48	DIVERTER -GENERIC		054374004553
131455	6	48	COLD-GENUINE	940-510A	054374094394
101455▲	6	48	COLD-GENERIC		054374004621
131498	6	48	GENUINE	S40-511A	054374118403
101498▲	6	48	HOT, COLD & DIVERTER-GENERIC		054374125708
131774	12		HOT & COLD-GENUINE	S40-521A	054374126293



Pfister® New Style "Windsor"

Large.For Windsor faucets manufactured after 1996. Acrylic.

STOCK#	PK	CS	DESCRIPTION	MFG#	UPC#
131407	6	48	HOT-GENUINE	940-444	054374094127
131447	6	48	DIVERTER-GENUINE	940-444	054374094325
131457	6	48	COLD-GENUINE	940-444	054374094417

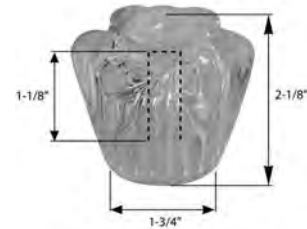

Pfister® "Windsor"

Large.

STOCK#	PK	CS	DESCRIPTION	MFG#	UPC#
131402	6	48	HOT-GENUINE	940-730A	054374094073
131442	6	48	DIVERTER-GENUINE	940-730A	054374094271
131452	6	48	COLD-GENUINE	940-730A	054374094363
131499	6	48	H-C-DIV-GENUINE	S40-741A	054374118397
101499	6	48	H-C-DIV-GENERIC		054374125715



Pfister® New Style "Verve"

Large.For Verve tub/shower faucets manufactured after 1996.

STOCK#	PK	CS	DESCRIPTION	MFG#	UPC#
131458	6	48	HOT-GENUINE	940-333	054374094424
131459	6	48	DIVERTER-GENUINE	940-333	054374094431
131460	6	48	COLD-GENUINE	940-333	054374094448
101395▲	1	6	HOT & COLD SET GENUINE	940-333A	054374528738



Pfister®

Pfister® Porcelain Cross Handles. Fits tub and shower and roman tub faucets. Sold less buttons.

STOCK#	PK	CS	DESCRIPTION	MFG#	UPC#
131349	6	72	LARGE-GENUINE	940-985	054374089680

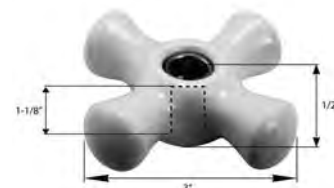

Replacement Handles

All handles include screws and buttons where applicable.

Pfister® "Avante"

Lever.

STOCK#	PK	CS	DESCRIPTION	MFG#	UPC#
101396	6	72	FOR AVANTE FAUCET-GENERIC		054374121847

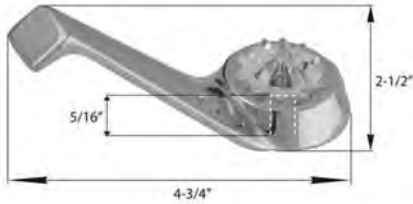

Pfister® "Avante"

Lucite Handles. Lavatory, Shower.

STOCK#	PK	CS	DESCRIPTION	MFG#	UPC#
131408	6	48	W/BUTTON GENUINE	940-240	054374094134
101408	6	48	W/BUTTON GENERIC		054374004256
131775	1	12	HANDLE ONLY GENUINE	S40-240	054374126316

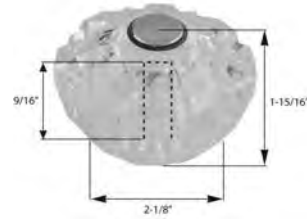

Sterling® Star-Flo™

Kitchen and lavatory faucets.

STOCK#	PK	CS	DESCRIPTION	MFG#	UPC#
101341	6	48	HOT		054374078738
101391	6	48	COLD		054374078745



Valley® - Small

Fits Valley II™ and Hi-Style™ faucets and valves. Also fits Sears and Aqualine faucets.

STOCK#	PK	CS	DESCRIPTION	MFG#	UPC#
101333	6	48	HOT		054374061099
101383	6	48	COLD		054374061105

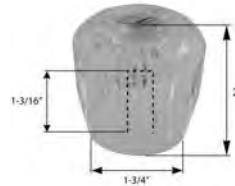

Valley® Lever Handle

Clear acrylic handle fits Valley® centersets and shower valves. Also fits Aqualine and Sears faucets.

STOCK#	PK	CS	DESCRIPTION	MFG#	UPC#
101394▲	6	72	SMALL	V6639	054374004157



SECTION 5 • PAGE 62

Delta® Button

Fits Delta® single control shower and lavatory acrylic handles.
Fits 131414 and 131418 handles.

STOCK#	PK	CS	DESCRIPTION	MFG#	UPC#
131326	6	144	OLD STYLE	RP2411	054374093939
131331	6	144	NEW STYLE	RP17446	054374093960

OLD STYLE



NEW STYLE



Kohler® Button Set

Trend plug button kit including hot, cold, and diverter for older style Trend faucets.

STOCK#	PK	CS	DESCRIPTION	MFG#	UPC#
131373	3	222	INDEX BUTTONS	GP30000	650531629746



Moen® Button Set

Fits Moen® Chateau lavatory, kitchen and tub and shower handles.

STOCK#	PK	CS	DESCRIPTION	MFG#	UPC#
131325	6	144	HOT, COLD & DIVERTER	M13382	054374105700



Pfister® "Verve" Index Buttons

Fits 131305, 131355, 131405, 131445, 131455 handles.

STOCK#	PK	CS	DESCRIPTION	MFG#	UPC#
131322	6	144	HOT/COLD/ DIVERTER SETS41-323	054374093922	

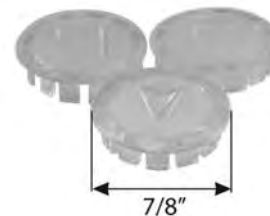

Pfister® "Windsor/Contessa" Index Button Set

Includes hot, cold and diverter buttons. Use with #1490 Lincoln handle.
Buttons also fit all other Windsor and Contessa handles. Fits 131307, 131357, 131402, 131404, 131442, 131444, 131452, 131454 handles.

STOCK#	PK	CS	DESCRIPTION	MFG#	UPC#
131329	6	144	CHROME PLATED	S41-323A	054374093946





Assorted Chrome Plated Handle Screws

4 Pieces.

STOCK#	PACK	CASE	DESCRIPTION	MFG#	UPC#
100171	6	144	ASSORTED HANDLE SCREWS	4 PER CARD	054374001491



American Standard® Kitchen Seal Kits

STOCK#	PACK	CASE	DESCRIPTION	MFG#	UPC#
131533	6	72	KITCHEN SEAL KIT	060366-0070AP	012611577901
131534	6	72	COLONY SEAL KIT	M960994-0070AP	012611577826



Aquaseal Washers

STOCK#	PACK	CASE	DESCRIPTION	MFG#	UPC#
130120	6	72	DIAPHRAGM - 2 PER CARD	072940-0070AP	012611578076
100120	6	144	WASHERS - W-46	2 PER CARD	054374001163
128521	12	144	WASHER - W-46	2 PER BAG	054374144327



Cadet Washers

STOCK#	PACK	CASE	DESCRIPTION	MFG#	UPC#
128522	12	144	WASHER -W-46A	2 PER BAG	054374443277

Briggs®

For Briggs® faucets. Bagged and bar coded.



STOCK#	PACK	CASE	DESCRIPTION	MFG#	UPC#
128610	12	144	STEP WASHER - EW-180	2 PER BAG	054374776818

Chicago® Stem Repair Kit

Contains: cap gasket, packing, packing ring seat, washer and retainer. Also included is a graphite swing spout washer. Repairs Lincoln stems 100421, 100471, 131577, and 131578.



STOCK#	PACK	CASE	DESCRIPTION	MFG#	UPC#
101119▲	6	144	REPAIR KIT		054374003204

Stem Washers

Stem washer for Chicago® faucets. Repairs Lincoln stems 100421, 100471, 131577, and 131578.



STOCK#	PACK	CASE	DESCRIPTION	MFG#	UPC#
128523	12	144	REGULAR WASHER-W-45	2 PER BAG	054374432776

Vacuum Breaker

Repairs both 1/2" and 3/8" atmospheric vacuum breakers. Vandal resistant. Contains screw, cap, seat, O-ring and poppet.



STOCK#	PACK	CASE	DESCRIPTION	MFG#	UPC#
131565▲	6	72	POLISHED CHROME	892-402KJKABNF	611943642860

Crane® Washer

For Crane®/Dial-Ese faucets. Bagged and bar coded.



STOCK#	PACK	CASE	DESCRIPTION	MFG#	UPC#
128524	12	144	REGULAR WASHER - EW-53	2 PER BAG	054374327768





Delta® Cam Assembly

For all Delta® single acrylic handle faucets.

STOCK#	PACK	CASE	DESCRIPTION	MFG#	UPC#
131130	6	144	SLOTTED SHAPED	RP188	054374100934



For all Delta® single metal handle faucets.

131136	6	144	HEART SHAPED	RP61	054374100941
--------	---	-----	--------------	------	--------------



Repair Kits

Repairs Delta® lever handle faucets. Contains springs, seats, O-rings, cam, wrench & instructions.

STOCK#	PACK	CASE	DESCRIPTION	MFG#	UPC#
131193	6	72	REPAIR KIT W/RP70 BALL	RP3614/RP70	054374157594



Delta®/Peerless® Repair Kits

Repairs all Delta® and Peerless® lever and Lucite handle models. Kit contains springs, seats, O-rings, cams (for both lever and lucite handle), wrench & instructions.

STOCK#	PACK	CASE	DESCRIPTION	MFG#	UPC#
131133	6	72	REPAIR KIT	RP3614	054374093564



Repair Delta® Lucite handle and all Peerless® single handle faucets. Kit contains springs, seats, O-rings, cam, wrench & instructions.

131132	6	72	REPAIR KIT	RP2078	054374100927
131196▲	6	72	REPAIR KIT W/RP212 BALL	RP3616/RP212	039166088430

Seats and Springs

Repairs all Delta® and Peerless® faucets. Kit contains (2) new style springs and (2) seats.

STOCK#	PACK	CASE	DESCRIPTION	MFG#	UPC#
131139	6	144	SEATS & SPRINGS - 2 PER CARD	RP4993	054374093588
101140▲	6	144	SEATS/SPRNGS-ALL STYLES		054374873838
101192▲	6	144	SEAT & SPRINGS		054374801145



Cap Assembly

Repairs all Delta® chrome lever and acrylic handle faucets. Chrome Plated.

STOCK#	PACK	CASE	DESCRIPTION	MFG#	UPC#
131143	6	72	CAP ASSEMBLY	RP50	054374093618



O-Rings

For Delta® and Peerless® swing spouts.

STOCK#	PACK	CASE	DESCRIPTION	MFG#	UPC#
131135	6	144	O-RINGS - 4 PER CARD	RP25	054374093571

Contains replacement O-ring for stems and swing spouts on all two handle Delex and Peerless faucets. Seven O-rings.

131140	6	144	O-RINGS - 7 PER CARD	RP2055	054374093595
--------	---	-----	----------------------	--------	--------------



Check Stop Stem Assembly

For 600/1600 Series Valves

STOCK#	PACK	CASE	DESCRIPTION	MFG#	UPC#
131743	1		CHECK STOP ASSEMBLY	RP2090	034449107501

SECTION 5 • PAGE 66



Delta® (Continued) Push Button Diverter

Push button diverter for Delta® tub and shower valves.

STOCK#	PACK	CASE	DESCRIPTION	MFG#	UPC#
131138▲	6	72	DIVERTER	RP5649	054374101016



Diverter Assemblies

For Delta® and Peerless® single handle kitchen and deck faucets with hose spray.

STOCK#	PACK	CASE	DESCRIPTION	MFG#	UPC#
131735	6	144	DIVERTER ASSEMBLY	RP63136	054374066902



For two handle faucets with spray.

131736	6	144	DIVERTER ASSEMBLY	RP63135	054374032020
--------	---	-----	-------------------	---------	--------------



Kohler® Spline Adaptor

Includes 2 (model No. 78125) spline adapters for use with 2-handle faucets with ceramic valves.

STOCK#	PACK	CASE	DESCRIPTION	MFG#	UPC#
131784	3	486	SPLINE ADAPTOR KIT - 2/CARD	GP1074231	650531629913



Stem Adapter

Fits Kohler® Coralais® bath and shower faucets.

STOCK#	PACK	CASE	DESCRIPTION	MFG#	UPC#
131788	1		2-1/2" X 2" WHITE	71906	040688419978



Moen® O-Rings

Fits Moen® brass or plastic cartridges. Includes a silicone grease capsule.

STOCK#	PACK	CASE	DESCRIPTION	MFG#	UPC#
131107	6	144	O-RING KIT	117	054374116416



Contains eight O-rings to repair Moen® cartridges and spouts. Repairs Lincoln stems 132306, 132307, 102306, and 102313.

STOCK#	PACK	CASE	DESCRIPTION	MFG#	UPC#
131120	6	144	DIALCET REPAIR KIT		054374093557



Cartridge Retainer Clips

Contains one lavatory and kitchen cartridge retainer clip, and one tub and shower cartridge retainer clip.

STOCK#	PACK	CASE	DESCRIPTION	MFG#	UPC#
131149	6	144	REPAIR KIT	96365	054374105663



For single handle lavatory, tub/shower valves.

131711	6	144	RETAINER CLIP	883	054374116430
--------	---	-----	---------------	-----	--------------



Retainer clip for single handle kitchen faucets.

131712	6	144	RETAINER CLIPS - 6 PER CARD	1883	054374116386
--------	---	-----	-----------------------------	------	--------------



Stop Check Valve

Fits Moentrol™ tub and shower valves.

STOCK#	PACK	CASE	DESCRIPTION	MFG#	UPC#
131151▲	6	144	CHECK VALVE	12318	054374105687





Moen® (Continued) Push Button Diverter

Fits Moen® tub and shower valves.

STOCK#	PACK	CASE	DESCRIPTION	MFG#	UPC#
131152▲	6	72	CHROME PLATED	1198	054374105847



Handle Kit

Connector for loop handle.

STOCK#	PACK	CASE	DESCRIPTION	MFG#	UPC#
131713	6	144	CONNECTION KIT	101099	054374123070



Balancing Spool

Fits Moentrol™ tub and shower valves.

STOCK#	PACK	CASE	DESCRIPTION	MFG#	UPC#
132343▲	6	144	BALANCING SPOOL	1423	054374110018



Monogram Brass® Repair Kit

Contains seats, springs, cam, cam gasket, o-rings and wrench to repair Monogram Brass® faucets and many Asian import faucets.

STOCK#	PACK	CASE	DESCRIPTION	MFG#	UPC#
101190▲	6	72	REPAIR KIT		054374106028



Seats & Springs

Contains 2 each seats and springs for Monogram Brass faucets and many Asian import faucets.

STOCK#	PACK	CASE	DESCRIPTION	MFG#	UPC#
101191▲	6	144	SEATS & SPRINGS		054374105267



Pfister® Stem Washer Kit

Contains bibb washer, O-ring, fibre washer and bibb washer screw. Repairs Lincoln stems 130400, 130450, 100400, 100450, 100401, 100451, 130403, 130486, 130412, 100403. (Also fits old style Harcraft® stems).

STOCK#	PACK	CASE	DESCRIPTION	MFG#	UPC#
131100▲	6	48	STEM WASHER KIT	S50-011	054374093489



Stem Cartridge Washer

Bagged and bar coded.

STOCK#	PACK	CASE	DESCRIPTION	MFG#	UPC#
128525	12	144	CARTRIDGE WASHER	2 PER BAG	054374277681

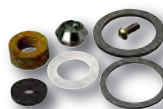

Repair Kits for Shower Stems

Contains a fiber stem washer, stem washer, bonnet packing, diverter stem washer and flat bibb washer. Repairs Lincoln stems 102462, 102453, 132440, 132403, 102410, 132410, 132411, 132412 and 102461.

STOCK#	PACK	CASE	DESCRIPTION	MFG#	UPC#
131104	6	144	REPAIR KIT	S50-011	054374093502
131154▲	6	144	REPAIR KIT WITH SEAT & SCREW		054374107841
128623	12	144	DIVERTER STEM WASHER - 2 PER BAG	950-040	054374189144

SECTION 5 • PAGE 68



Pfister® (Continued) Repair Kit for Avante & Flowmatic

For Avante and new style Flowmatic single control kitchen faucets. Contains body and spout O-rings.

STOCK#	PACK	CASE	DESCRIPTION	MFG#	UPC#
131109	6	144	REPAIR KIT	S50-801	054374094905

Hydro-Seals

Fits washerless stem cartridge, kitchen and lavatory. Also fits Pfister® Society and American Bath. Fits Lincoln stems 100409 and 100459.



STOCK#	PACK	CASE	DESCRIPTION	MFG#	UPC#
131112▲	6	144	HYDRO SEALS - 2 PER CARD	949-360	054374093533
101112▲	6	144	HYDRO SEALS - 2 PER CARD		054374003143
131559	6	144	HYDRO SEALS - 4 PER CARD	949-360	054374121427

Widespread Repair Kit

Contains bibb washer, screw, o-ring and bonnet washer for Pfister® widespread concealed deck and roman tub faucets. Fits Lincoln stems 132312, 100481 and 100482.



STOCK#	PACK	CASE	DESCRIPTION	MFG#	UPC#
131115▲	6	144	REPAIR KIT	950-190	054374105656

Valve Seals

For ceramic cartridges. Tub and shower valves.



STOCK#	PACK	CASE	DESCRIPTION	MFG#	UPC#
131156	6	144	VALVE SEALS	950-001	054374121809

Nut and Packing

Fits Crown Imperial, Beaux Art, Contempra, Contessa, Marquis, Verve and Windsor shower valve bonnets.

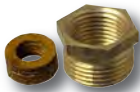

STOCK#	PACK	CASE	DESCRIPTION	MFG#	UPC#
132406▲	6	144	NUT AND PACKING	930-020	054374094684

Repcal® / Sterling® Washer Kit

Contains two bibb washer, (1/4S Flat and 1/4R Flat), O-ring, fibre washer and bibb washer screw.



STOCK#	PACK	CASE	DESCRIPTION	MFG#	UPC#
101101▲	6	144	WASHER KIT		054374003037

Valley® / Aqualine® Seats and Springs

Repairs lever and crystal handles faucets. Includes nylon insert guide.



STOCK#	PACK	CASE	DESCRIPTION	MFG#	UPC#
101161▲	6	144	SEATS AND SPRINGS	2 PER CARD	054374003471

Emergency Plumbing Repair Kit

Includes assorted washers and screws for faucets, traps, basins and valves.

Comes in reusable plastic pack.



STOCK#	PACK	CASE	DESCRIPTION	MFG#	UPC#
100181▲	6	144	EMERGENCY REPAIR KIT		054374001514



▲ For Proposition 65 warnings please refer to pages 93-124 at the end of this section.

All Products Used for Potable Water are:





Silicone Faucet Grease

All purpose lubricant with Silicone reduces wear on faucets, valves, pumps etc. Also aids installation of faucet spouts, O-rings and stem repair kits.

STOCK#	PACK	CASE	DESCRIPTION	UPC#
100187	6	144	1/2 OZ. TUB	054374093540



Plumbers Grease

All purpose lubricant reduces wear on faucets, valves, pumps etc. Also aids installation of faucet spouts, O-rings and stem repair kits.

STOCK#	PACK	CASE	DESCRIPTION	UPC#
100188	6	144	PLUMBERS GREASE	054374001545



Rubber Sheet Packing

Make washers and gaskets quickly and easily. One piece: 1/16" x 5-7/8" square.

STOCK#	PACK	CASE	DESCRIPTION	UPC#
100190▲	6	72	RUBBER PACKING	054374001552

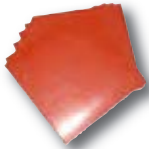

Rubber Sheet Packing Assortment

Use to make your own packing and gaskets. Assortment contains 8 1/16" thick sheets and 4 1/8" thick sheets.

STOCK#	PACK	CASE	DESCRIPTION	UPC#
300919	1	1	6" X 6" - 12 PACK	P-15R 644430143137

SECTION 5 • PAGE 69



See pages 72-75 for actual size illustrations.



O-Ring Kit

Re-closeable box contains 14 popular O-Rings. Includes .5 oz tub of silicone faucet grease.

STOCK#	PACK	CASE	DESCRIPTION	UPC#
110160▲	3		ASSORTED O-RINGS-EACH	BOXED 054374149148

Refills for O-Rings Kit

See pages 72-75 for actual size illustrations.

STOCK#	PACK	CASE	DESCRIPTION	UPC#
110142	12	144	R-64 RUBBER O-RINGS	12 PER BAG 054374864072
110143	12	144	R-43 RUBBER O-RINGS	12 PER BAG 054374269686
110144	12	144	R-46 RUBBER O-RINGS	12 PER BAG 054374833702
110145	12	144	R-44 RUBBER O-RINGS	12 PER BAG 054374337026
110146	12	144	R-57 RUBBER O-RINGS	12 PER BAG 054374720026
110147	12	144	R-47 RUBBER O-RINGS	12 PER BAG 054374026968
110148	12	144	R-48 RUBBER O-RINGS	12 PER BAG 054374696864
110149	12	144	R-49 RUBBER O-RINGS	12 PER BAG 054374686407
110150	12	144	R-50 RUBBER O-RINGS	12 PER BAG 054374702695
110151	12	144	R-51 RUBBER O-RINGS	12 PER BAG 054374968640
110153	12	144	R-53 RUBBER O-RINGS	12 PER BAG 054374640720
110154	12	144	R-80 RUBBER O-RINGS	12 PER BAG 054374407200
110161	12	144	R-61 RUBBER O-RINGS	12 PER BAG 054374720026
110165	12	144	R-82 RUBBER O-RINGS	12 PER BAG 054374072002



Rubber O-Rings

For Arrowhead®, Chase®, Consolidated®, Gopher®, General Brass®, Globe Valve®, Harcraft®, Indiana Brass®, Milwaukee Valve®, Pfister®, Repcal®, Savoy®, Sterling®, Wards®, Western Brass®.

STOCK#	PACK	CASE	TRADE#	I.D.	O.D.	THICK	UPC#
100150▲	6	144	R-50	3/8"	9/16"	3/32"	4 PER CARD 054374074372

For American Standard®, Arrowhead®, Chase®, Gopher®, Sears™

100160▲	6	144	ASSORTED CONTAINS 2 OF EACH: R-43, R-48, R-50				054374001415
---------	---	-----	---	--	--	--	--------------

Rubber O-Rings

See pages 72-75 for actual size illustrations.

Bagged and bar coded.

STOCK#	PACK	CASE	TRADE#	I.D.	O.D.	THICK	UPC#
128001▲	12	144	R70A	1/8"	1/4"	1/16"	2 PER BAG 054374465484
128002▲	12	144	R-71A	5/32"	9/32"	1/16"	2 PER BAG 054374654840
128003▲	12	144	R-79	3/16"	5/16"	1/16"	2 PER BAG 054374548408
128004▲	12	144	R-73A	7/32"	11/32"	1/16"	2 PER BAG 054374484089
128005▲	12	144	R-46	1/4"	3/8"	1/16"	2 PER BAG 054374840892
128006▲	12	144	R-44	5/16"	7/16"	1/16"	2 PER BAG 054374408924
128007▲	12	144	R-57	3/8"	1/2"	1/16"	2 PER BAG 054374089253
128008▲	12	144	R-68	27/64"	35/64"	1/16"	2 PER BAG 054374892532
128009▲	12	144	R-64	1/2"	5/8"	1/16"	2 PER BAG 054374925322
128010▲	12	144	R-74A	9/16"	11/16"	1/16"	2 PER BAG 054374253227
128011▲	12	144	R-65	15/16"	1-1/16"	1/16"	2 PER BAG 054374532278
128012▲	12	144	R-69	7/8"	1"	1/16"	2 PER BAG 054374322787
128013▲	12	144	R-78	13/16"	15/16"	1/16"	2 PER BAG 054374227877



Rubber O-Rings

See pages 72-75 for actual size illustrations.

Rubber O-Rings (Continued)



STOCK#	PACK	CASE	TRADE#	DESCRIPTION			UPC#
				I.D.	O.D.	THICK	
128014▲	12	144	R-59	3/4"	7/8"	1/16"	2 PER BAG 054374278770
128015▲	12	144	R-80	11/16"	13/16"	1/16"	2 PER BAG 054374787708
128016▲	12	144	R-71	5/8"	3/4"	1/16"	2 PER BAG 054374877089
128017▲	12	144		1"	1-1/8"	1/16"	2 PER BAG 054374770892
128018▲	12	144	R-62	1-1/16"	1-3/16"	1/16"	2 PER BAG 054374708925
128021▲	12	144		1-1/4"	1-3/8"	1/16"	2 PER BAG 054374089260
128022▲	12	144	R-76	1-5/8"	1-3/4"	1/16"	2 PER BAG 054374892600
128029▲	12	144		1/4"	7/16"	3/32"	2 PER BAG 054374926008
128030▲	12	144		5/16"	1/2"	3/32"	2 PER BAG 054374260089
128031▲	12	144	R-50	3/8"	9/16"	3/32"	2 PER BAG 054374600892
128032▲	12	144	R-47	7/16"	5/8"	3/32"	2 PER BAG 054374010035
128033▲	12	144	R-43	1/2"	11/16"	3/32"	2 PER BAG 054374100385
128034▲	12	144	R-48	9/16"	3/4"	3/32"	2 PER BAG 054374004126
128035▲	12	144	R-51	5/8"	13/16"	3/32"	2 PER BAG 054374041268
128036▲	12	144	R-49	11/16"	7/8"	3/32"	2 PER BAG 054374412686
128037▲	12	144		1-1/16"	1-1/4"	3/32"	2 PER BAG 054374126866
128038▲	12	144	R-63	1"	1-3/16"	3/32"	2 PER BAG 054374268665
128039▲	12	144	R-72	15/16"	1-1/8"	3/32"	2 PER BAG 054374686650
128040▲	12	144	R-54	7/8"	1-1/16"	3/32"	2 PER BAG 054374866502
128041▲	12	144		13/16"	1"	3/32"	2 PER BAG 054374665020
128042▲	12	144	R-52	3/4"	15/16"	3/32"	2 PER BAG 054374650200
128043▲	12	144		1-1/8"	1-5/16"	3/32"	2 PER BAG 054374502004
128044▲	12	144	R-82	1-3/16"	1-3/8"	3/32"	2 PER BAG 054374020041
128045▲	12	144	R-83	1-1/4"	1-7/16"	3/32"	2 PER BAG 054374200412
128046▲	12	144	R-61	1-5/16"	1-1/2"	3/32"	2 PER BAG 054374004249
128047▲	12	144		1-3/8"	1-9/16"	3/32"	2 PER BAG 054374042500
128048▲	12	144		1-11/16"	1-7/8"	3/32"	2 PER BAG 054374425006
128049▲	12	144		1-5/8"	1-13/16"	3/32"	2 PER BAG 054374250066
128050▲	12	144		1-9/16"	1-3/4"	3/32"	2 PER BAG 054374500666
128053▲	12	144		1-3/4"	1-15/16"	3/32"	2 PER BAG 054374006786
128058▲	12	144		1/4"	1/2"	1/8"	2 PER BAG 054374067862
128059▲	12	144	R-66	19/64"	37/64"	9/64"	2 PER BAG 054374678624
128060▲	12	144	R-101	3/8"	5/8"	1/8"	2 PER BAG 054374786244
128061▲	12	144	R-55	27/64"	45/64"	9/64"	2 PER BAG 054374862443
128062▲	12	144		1/2"	3/4"	1/8"	2 PER BAG 054374624430
128063▲	12	144		9/16"	13/16"	1/8"	2 PER BAG 054374244300
128064▲	12	144		5/8"	7/8"	1/8"	2 PER BAG 054374443000
128065▲	12	144		11/16"	15/16"	1/8"	2 PER BAG 054374430000
128066▲	12	144		1-1/16"	1-5/16"	1/8"	2 PER BAG 054374300006
128067▲	12	144	R-94	1"	1-1/4"	1/8"	2 PER BAG 054374000067
128068▲	12	144	R-73	1-3/16"	15/16"	1/8"	2 PER BAG 054374000708
128069▲	12	144	R-56	7/8"	1-1/8"	1/8"	2 PER BAG 054374007547
128070▲	12	144	R-53	13/16"	1-1/16"	1/8"	2 PER BAG 054374078103
128071▲	12	144	R-45	3/4"	1"	1/8"	2 PER BAG 054374781034
128072▲	12	144	R-58	1-1/8"	1-3/8"	1/8"	2 PER BAG 054374810345
128073▲	12	144		1-3/16"	1-7/16"	1/8"	2 PER BAG 054374103478
128074▲	12	144	R-75	1-1/4"	1-1/2"	1/8"	2 PER BAG 054374034918
128075▲	12	144	R-67	1-9/32"	1-9/16"	9/64"	2 PER BAG 054374349180
128076▲	12	144		1-5/8"	1-7/8"	1/8"	2 PER BAG 054374491803
128077▲	12	144		1-1/2"	1-3/4"	1/8"	2 PER BAG 054374918034
128078▲	12	144		1-7/16"	1-11/16"	1/8"	2 PER BAG 054374180349
128079▲	12	144		1-3/8"	1-5/8"	1/8"	2 PER BAG 054374803491

SECTION 5 • PAGE 71



▲ For Proposition 65 warnings please refer to pages 93-124 at the end of this section.

All Products Used for Potable Water are:



Rubber O-Rings Chart

ALL ILLUSTRATIONS ARE SHOWN ACTUAL SIZE.

1-16" Wall Nominal O-Rings

R-70A



128001

R-71A



128002

R-79



128003

R-73A



128004

R-46



128005

R-44



128006

R-57



128007

R-68



128008

R-64



128009

R-74A



128010

R-71



128016

R-80



128015

R-59

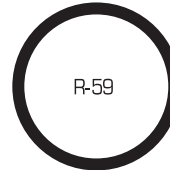

128014

R-78

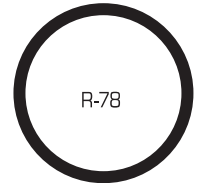

128013

R-69

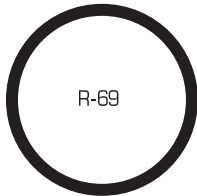

128012

R-65

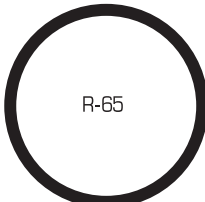

128011

R-62

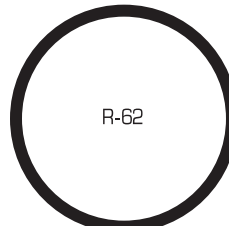

128018

R-76

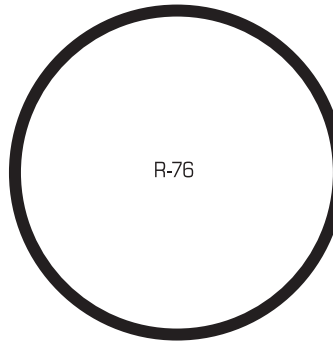

128022

128021

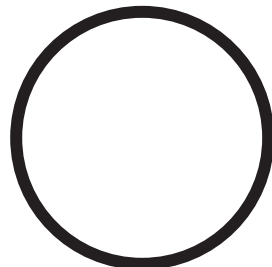

SECTION 5 • PAGE 72



Rubber O-Rings Chart

ALL ILLUSTRATIONS ARE SHOWN ACTUAL SIZE.

1/8" Wall Nominal Size O-Rings

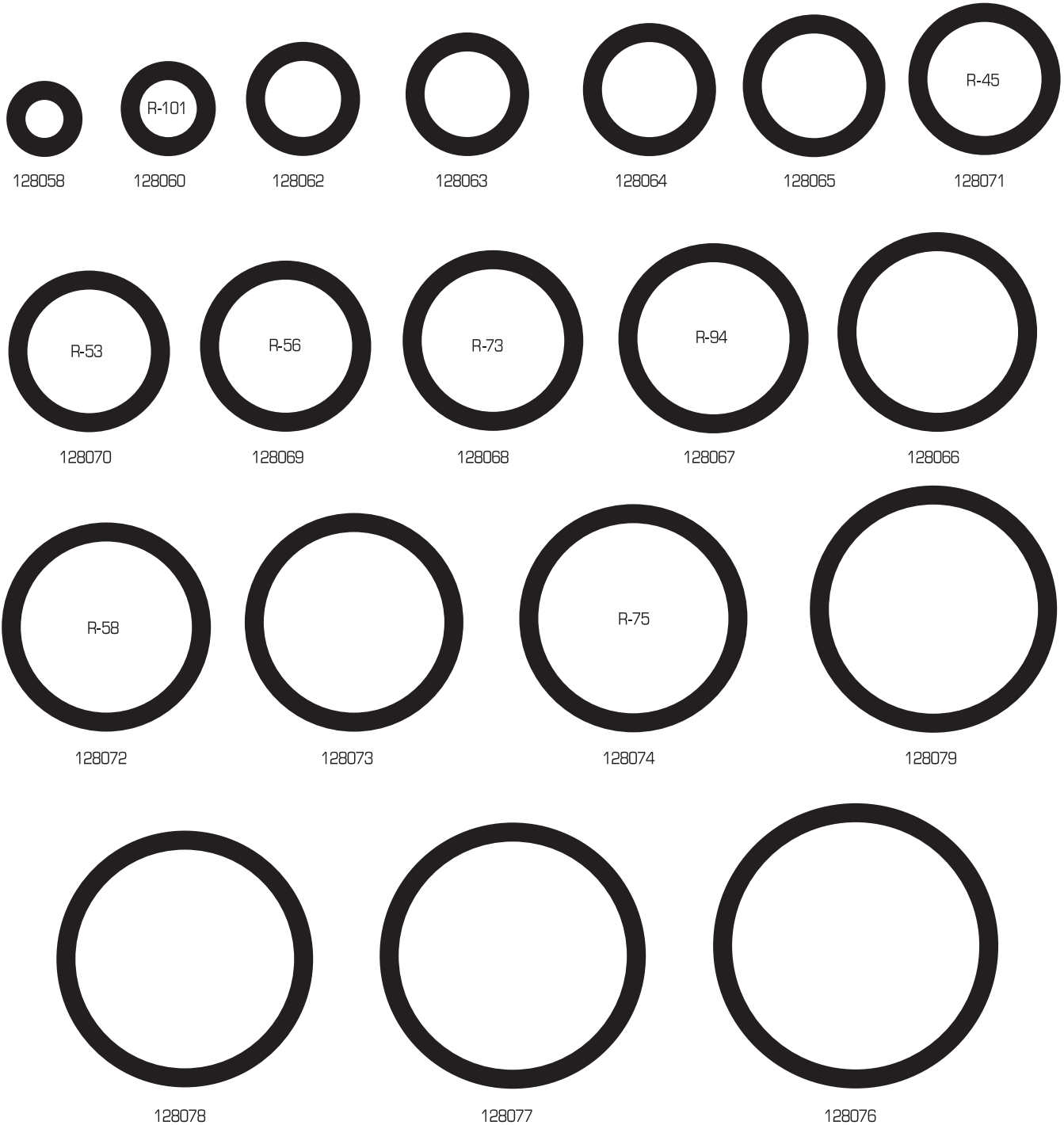

Rubber O-Rings Chart

ALL ILLUSTRATIONS ARE SHOWN ACTUAL SIZE.

3/32" Wall Nominal Size O-Rings

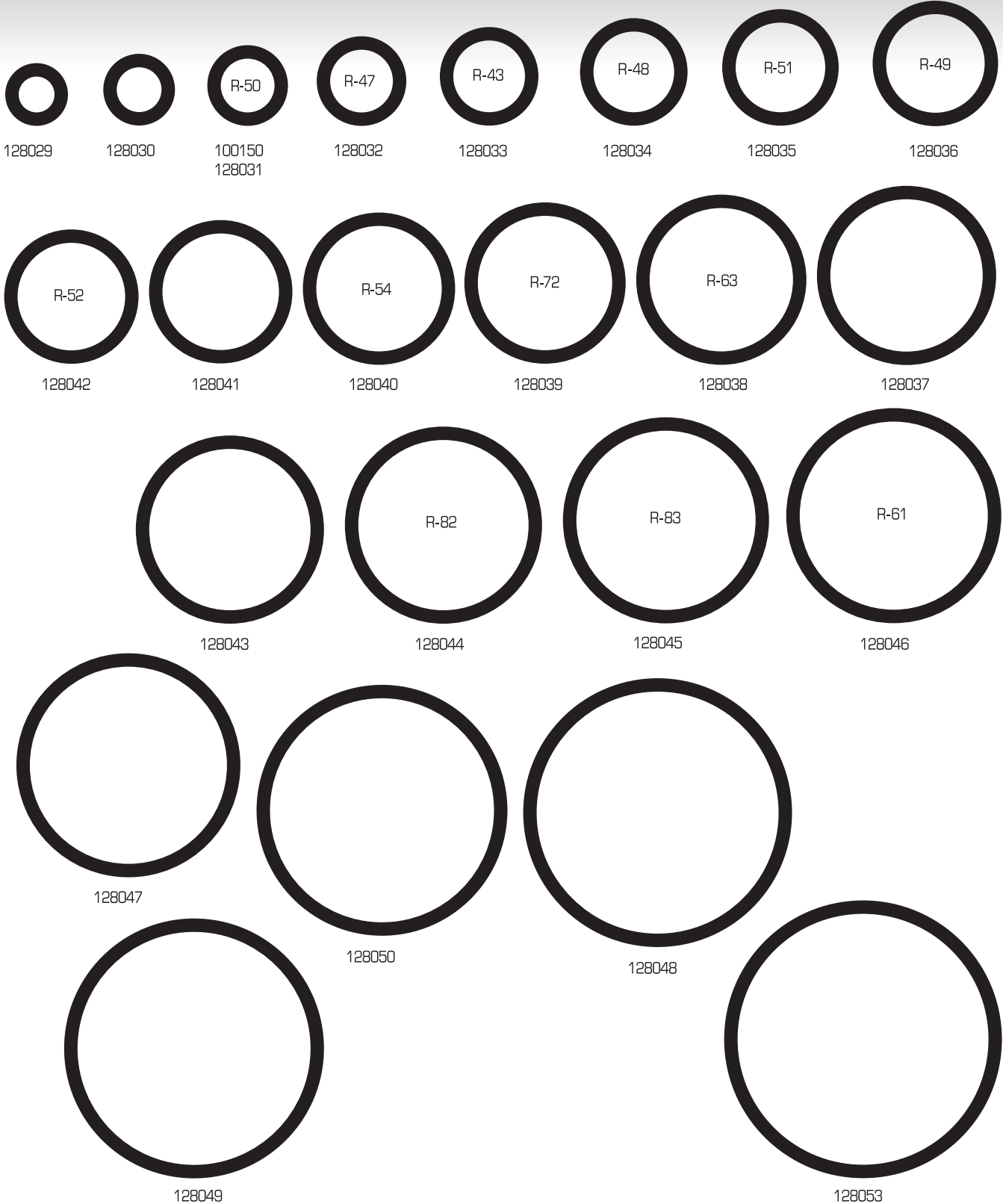

SECTION 5 • PAGE 74



Rubber O-Rings Chart

ALL ILLUSTRATIONS ARE SHOWN ACTUAL SIZE.

9/64" Wall Nominal Size O-Rings



128059



128061

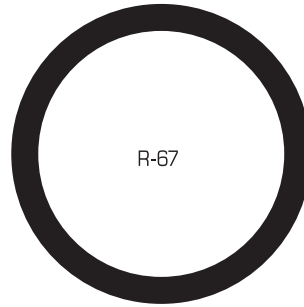

128075



Lincoln faucet washers are made from the highest quality neoprene and are precision molded to provide long life.



Beveled Bibb Washer Kit

Re-closeable box contains "00", "0", 1/4L, 3/8R,3/8L, 1/2L washers and 1/2 X 8/32, 1/2 X 10/24 and 1/2 X 10/32 brass bibb screws.

STOCK#	PACK	CASE	DESCRIPTION	UPC#
110109▲	3		ASSORTED BEVELED BIBB WASHERS-EACH	BOXED 054374255610



Flat Bibb Washer Kit

Re-closeable box contains "00", "0", 1/2r, 1/4L, 3/8R,3/8L, 1/2R washers and 3/8 X 8/32, 3/8 X 10/24 and 3/8 X 10/32 Brass Bibb Screws

STOCK#	PACK	CASE	DESCRIPTION	UPC#
110119▲	4		ASSORTED FLAT WASHERS-EACH	BOXED 054374063857

Refills for Beveled & Flat Washer Kits

STOCK#	PACK	CASE	DESCRIPTION	UPC#
128468	12	144	BEVELED WASHERS - 00	4 PER BAG 054374766406
128469	12	144	BEVELED WASHERS - 0	4 PER BAG 054374664061
128470	12	144	BEVELED WASHERS-1/4	4 PER BAG 054374640614
128471	12	144	BEVELED WASHERS-1/4L	4 PER BAG 054374406142
128472	12	144	BEVELED WASHERS-3/8	4 PER BAG 054374061440
128473	12	144	BEVELED WASHERS-3/8M	4 PER BAG 054374614400
128474	12	144	BEVELED WASHERS-3/8L	4 PER BAG 054374144310
128475	12	144	BEVELED WASHERS-1/2	4 PER BAG 054374443109
128450	12	144	FLAT WASHERS - 000	4 PER BAG 054374106141
128451	12	144	FLAT WASHERS - 00	4 PER BAG 054374061426
128452	12	144	FLAT WASHERS - 0	4 PER BAG 054374061426
128453	12	144	FLAT WASHERS - 1/4	4 PER BAG 054374142644
128454	12	144	FLAT WASHERS - 1/4L	4 PER BAG 054374426447
128455	12	144	FLAT WASHERS - 3/8	4 PER BAG 054374264476
128456	12	144	FLAT WASHERS - 3/8M	4 PER BAG 054374644766
128457	12	144	FLAT WASHERS - 3/8L	4 PER BAG 054374447664
128458	12	144	FLAT WASHERS - 1/2	4 PER BAG 054374476640
119253▲	12	144	1/2 X 8-32 BRASS BIBB SCREWS	12 PER BAG 054374106349
119254▲	12	144	3/8 X 10-32 BRASS BIBB SCREWS	12 PER BAG 054374187157
119255▲	12	144	1/2 X 10-32 BRASS BIBB SCREWS	12 PER BAG 054374871575
119256▲	12	144	3/8 X 10-28 BRASS BIBB SCREWS	12 PER BAG 054374754984
119257▲	12	144	1/2 X 10-28 BRASS BIBB SCREWS	12 PER BAG 054374063833
119259▲	12	144	1/2 X 10-24 BRASS BIBB SCREWS	12 PER BAG 054374638338

Assorted Brass Bibb Screws

STOCK#	PACK	CASE	DESCRIPTION	UPC#
100170▲	6	144	ASSORTED BIBB SCREWS	6 PER CARD 054374001484

Brass Bibb Screws

Fits faucet washers. Solid brass. Bagged and bar coded.

STOCK#	PACK	CASE	TRADE#	DESCRIPTION	UPC#
128252▲	12	144	S-8	3/8"X 8-32 THREAD	2 PER BAG 054374730292
128253▲	12	144	S-6	1/2"X 8-32 THREAD	2 PER BAG 054374302925
128256▲	12	144		3/8"X 10-28 THREAD	2 PER BAG 054374029297
128258▲	12	144	S-9	3/8"X 10-24 THREAD	2 PER BAG 054374292974
128259▲	12	144		1/2"X 10-24 THREAD	2 PER BAG 054374929740



Lincoln faucet washers are made from the highest quality neoprene and are precision molded to provide long life.



Assorted Beveled Washers and Screws

Includes washers (16) and brass screws (4).

STOCK#	PACK	CASE	DESCRIPTION	UPC#
100109▲	6	144	ASSORTED WITH SCREWS	054374001057

Beveled Bibb Washers

STOCK#	PACK	CASE	DESCRIPTION	UPC#
			O.D.	
100101	6	144	1/4S ("00") 1/2"	6 PER CARD 054374000975
100107	6	144	3/8L 11/16"	4 PER CARD 054374001033
128468	12	144	00 1/2"	4 PER BAG 054374766406
128469	12	144	0 17/32"	4 PER BAG 054374664061
128470	12	144	1/4 9/16"	4 PER BAG 054374640614
128471	12	144	1/4L 19/32"	4 PER BAG 054374406142
128472	12	144	3/8 5/8"	4 PER BAG 054374061440
128473	12	144	3/8M 21/32"	4 PER BAG 054374614400
128474	12	144	3/8L 11/16"	4 PER BAG 054374144310
128475	12	144	1/2 3/4"	4 PER BAG 054374443109



Assorted Flat Washers and Screws

Includes washers (16) and brass screws (4).

STOCK#	PACK	CASE	DESCRIPTION	UPC#
100119▲	6	144	ASSORTED WITH SCREWS	054374001156



Flat Bibb Washers

See page 78 for actual size illustrations.

STOCK#	PACK	CASE	DESCRIPTION	UPC#
			O.D.	
100111	6	144	1/4S ("00") 1/2"	6 PER CARD 054374001071
100112	6	144	1/4M ("0") 17/32"	6 PER CARD 054374001088
100113	6	144	1/4R 9/16"	6 PER CARD 054374001095
100114	6	144	1/4L 19/32"	6 PER CARD 054374001101
100115	6	144	3/8R 5/8"	6 PER CARD 054374001118
100116	6	144	3/8M 21/32"	6 PER CARD 054374001125
100117	6	144	3/8L 11/16"	4 PER CARD 054374001132
100118	6	144	1/2R 3/4"	4 PER CARD 054374001149
128450	12	144	000 15/32"	4 PER BAG 054374106141
128451	12	144	00 1/2"	4 PER BAG 054374061426
128452	12	144	0 17/32"	4 PER BAG 054374614264
128453	12	144	1/4 9/16"	4 PER BAG 054374142644
128454	12	144	1/4L 19/32"	4 PER BAG 054374426447
128455	12	144	3/8 5/8"	4 PER BAG 054374264476
128456	12	144	3/8M 21/32"	4 PER BAG 054374644766
128457	12	144	3/8L 11/16"	4 PER BAG 054374447664
128458	12	144	1/2 3/4"	4 PER BAG 054374476640



Flat Bibb Washers Chart

Shown Actual Size

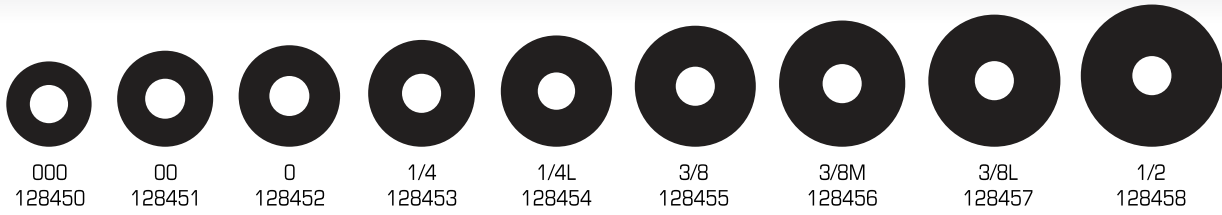

SECTION 5 • PAGE 78

Fiber Washers

See page 79 for actual size illustrations.

Bagged and bar coded.



STOCK#	PACK	CASE	TRADE#	DESCRIPTION			UPC#
				I.D.	O.D.	THICK	
128384	12	144	EW398-29D	13/32"	21/32"	3/64"	2 PER BAG 054374303267
128386	12	144	EW398-37G	3/4"	29/32"	1/16"	2 PER BAG 054374032785
128388	12	144	EW398-62B	3/4"	7/8"	1/16"	2 PER BAG 054374327850
128390	12	144	EW398-67D	5/8"	3/4"	1/32"	2 PER BAG 054374278503
128400	12	144	EW-400	7/16"	21/32"	1/32"	2 PER BAG 054374785032
128402	12	144	EW-402	3/8"	23/32"	1/8"	2 PER BAG 054374850327
128407	12	144	EW-407	9/16"	29/32"	1/8"	2 PER BAG 054374032808
128410	12	144	EW-410	3/4"	1"	1/16"	2 PER BAG 054374328086
128413	12	144	EW-413	7/8"	1-1/32"	1/16"	2 PER BAG 054374280865
128415	12	144	EW-415	7/8"	1-3/16"	1/16"	2 PER BAG 054374808656
128416	12	144	EW-416	1"	1-1/4"	1/16"	2 PER BAG 054374086597
128417	12	144	EW-416	1-9/32"	1-9/16"	1/16"	2 PER BAG 054374865970
128418	12	144	EW-418	1-7/16"	1-23/32"	1/16"	2 PER BAG 054374659708
128420	12	144	EW-420	1-11/16"	1-29/32"	1/32"	2 PER BAG 054374597086
128426	12	144	EW-401A	3/4"	1"	1/16"	2 PER BAG 054374086610
128427	12	144	EW-402A	7/8"	1-1/8"	1/16"	2 PER BAG 054374866106
128433	12	144	EW-413A	1"	1-1/4"	1/32"	2 PER BAG 054374610600
128434	12	144	EW-416A	1-1/8"	1-3/8"	1/32"	2 PER BAG 054374106134
128435	12	144	EW-418A	1-1/4"	1-1/2"	1/32"	2 PER BAG 054374061341
128437	12	144	EW-422A	1-1/2"	1-3/4"	1/32"	2 PER BAG 054374613410



Fiber Washers Chart

ALL ILLUSTRATIONS ARE SHOWN ACTUAL SIZE.

Fiber Washers Size Chart

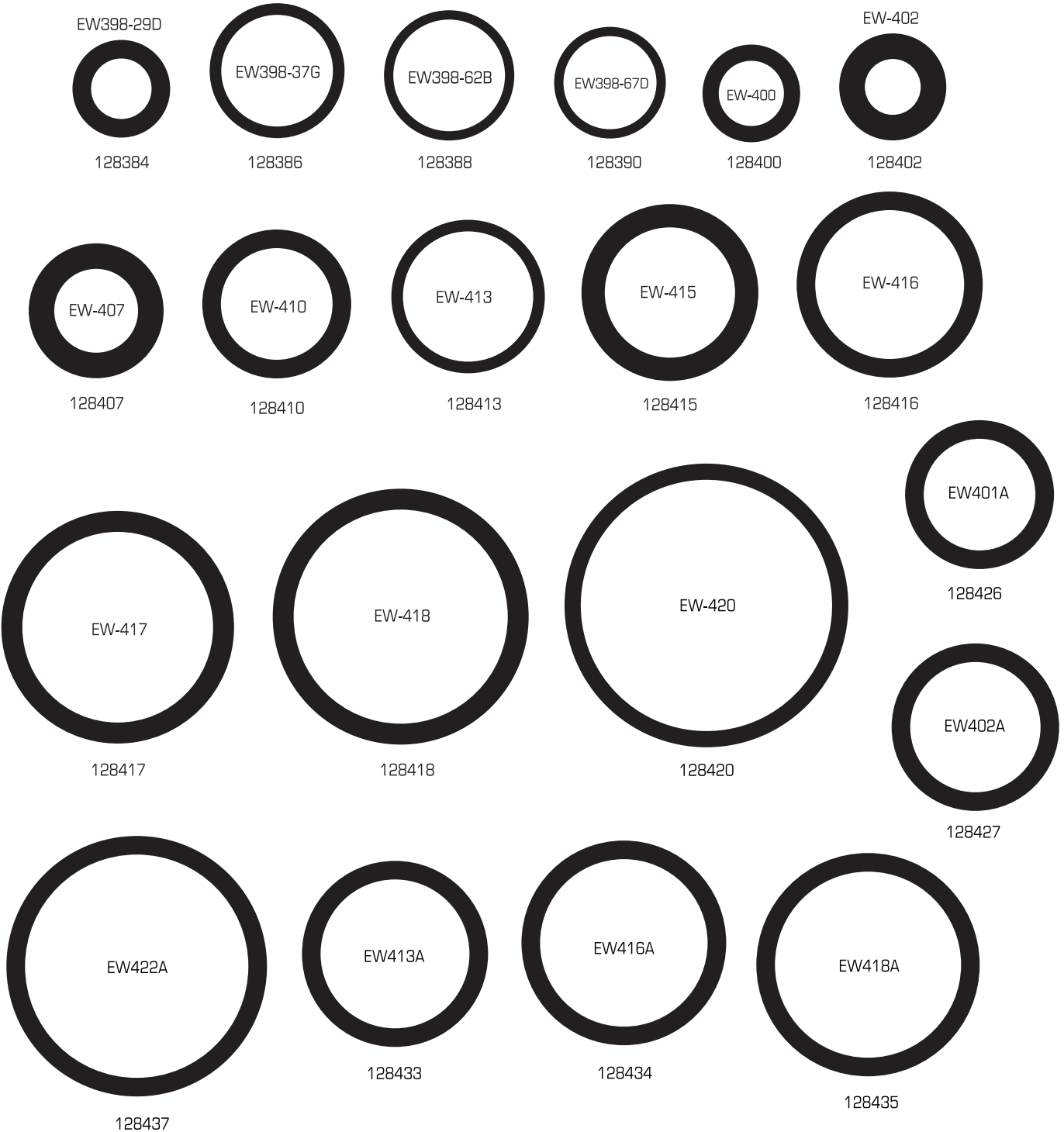



Bonnet Packings

Graphite stem packing. Individually bagged and bar coded.

STOCK#	PACK	CASE	TRADE#	I.D.	O.D.	THICK	DESCRIPTION	UPC#
128328	12	144	P99-20	11/32"	3/4"	3/16"	2 PER BAG	054374503278



Cone Bonnet Packing

Mica coated. Individually bagged and bar coded.

STOCK#	PACK	CASE	TRADE#	I.D.	O.D.	THICK	DESCRIPTION	UPC#
128335	12	144	P-59A	3/32"	11/16	9/32"	2 PER BAG	054374543502
128336	12	144	P-60	13/32"	3/4"	9/32"	2 PER BAG	054374435029



Square Type Duck Packing

Square cut rubber/fabric. Individually bagged and bar coded.

STOCK#	PACK	CASE	TRADE#	I.D.	O.D.	THICK	DESCRIPTION	UPC#
128341	12	144	P-81	13/32"	5/8"	5/16"	2 PER BAG	054374350292
128342	12	144	P-82	13/32"	3/4"	5/16"	2 PER BAG	054374502929
128343	12	144	P-83	3/8"	13/16"	3/8"	2 PER BAG	054374029303
128345	12	144	P-84A	7/16"	7/8"	1/4"	2 PER BAG	054374293032



Assorted Square Cut Packing

3 pieces. Combination of graphite, rubber cement binder and cotton fibre.

STOCK#	PACK	CASE	DESCRIPTION	UPC#
100194	6	144	ASSORTED	054374001576



Form-A-Washer

Graphite string packing may be formed into washers to repair leaking valves and faucets. 24" long.

STOCK#	PACK	CASE	DESCRIPTION	UPC#
100182	6	144	FORM-A-WASHER	054374001521



Union Washers - 1/2", 3/4" and 1"

A selection of rubber union washers for shower valve unions. Contains two of each size.

STOCK#	PACK	CASE	DESCRIPTION	UPC#
100226	6	144	WASHERS	054374001828



PTFE Packing

PTFE string packing may be formed into washers to repair leaking valves and faucets. Used to repair valves, pumps and other types of equipment handling water, steam, alkalies and solvents. Extends packing life in general service valves. 13" long.

STOCK#	PACK	CASE	DESCRIPTION	UPC#
100183	6	144	PTFE STRING PACKING	054374001538



Monel Screws

Monel outlasts brass in corrosive conditions. Bagged and bar coded.

STOCK#	PACK	CASE	DESCRIPTION	UPC#
128273	12	144	3/8" X 10-24 THREAD	054374297405



Special Head Screws

Fits faucet handles. Chrome plated brass. Bagged and bar coded.

STOCK#	PACK	CASE	TRADE#	I.D.	O.D.	THICK	DESCRIPTION	UPC#
128287	12	144	S-507	OVAL	5/8"	X 10-24	THREAD	054374054350
128280	12	144	S-500	OVAL	1/2"	X 8-32	THREAD	054374132331
128281	12	144	S-501	TRUSS	1/2"	X 10-24	THREAD	054374740543
128286	12	144	s-506	OVAL	7/16"	X 10-24	THREAD	054374405435



Repair Parts

STOCK#	PACK	CASE	DESCRIPTION	MFG#	UPC#
680720▲	1		STAINLESS STEEL STEM AND HANDLE - HOT	54502	642889545021
680721▲	1		STAINLESS STEEL STEM AND HANDLE - COLD	54510	642889545106
680725▲	1		STAINLESS STEEL HOSE, HANDLE AND ADAPTER	71404	642889714045
680824▲	1		FLEX HOSE	2914	642889006904
680723▲	1		STAINLESS STEEL HANDLE 3/4"	71390	642889713901
680726▲	1		STAINLESS STEEL HOSE ADAPTER	70696	642889706965
680727▲	1		STAINLESS STEEL SPRAY VALVE	71307	642889713079
680833▲	1		PRE-RINSE BACK FLOW PREVENTER	2932-0002	642889007451
680728▲	1		STAINLESS STEEL STEM ASSEMBLY HOT	54518	642889545182
680729▲	1		STAINLESS STEEL STEM ASSEMBLY COLD	54526	642889545267
680730▲	1		STAINLESS STEEL 12" SWING SPOUT	54410	642889544109
680736▲	1		KIT FOR GLASS FILLER	71412	642889714120
680822▲	1		WALL BRACKET	2902-12	642889006416
680831▲	1		1" X 2" WASTE SOCKET KIT	84085	642889840850
680832▲	1		1" X 4" WASTE SOCKET KIT	84093	642889840935
680835▲	1		DRAINING NO OVERFLOW	22209	642889222090

T & S® Brass Commercial Parts

Swing Spouts

Stainless steel swing nozzle.

STOCK#	PACK	CASE	DESCRIPTION	MFG#	UPC#
680790▲	50	6"		59X	671262071093
680791▲	1	8"		T060X	671262071246
680760▲	1	10"		TO61CX	671262071307
680805▲	50	12"		62X	671262071581
680761▲	1	14"		T063X	671262071772

Spray Valves

Brass Pre-rise spray.

STOCK#	PACK	CASE	DESCRIPTION	MFG#	UPC#
680794▲	3	.65 GPM		B-0107-C	671262000772
680795▲	3	1.07 GPM		B-0107-J	671262762601
680807▲	25	1.6 GPM		B-0107	671262000741



44" Flex Hose

Stainless steel 44" hose.

STOCK#	PACK	CASE	DESCRIPTION	MFG#	UPC#
680806▲	25		STAINLESS STEEL	B44H	671262000437

Repair Parts

For Dishwasher Squeeze valves.

STOCK#	PACK	CASE	DESCRIPTION	MFG#	UPC#
680780▲	3		REMOVABLE BRS SEAT F/B-1100 SERIES	000763-20	671262025393
680781▲	3		SPINDLE HOT F/B-1100 SERIES	54510	671262025669
680782▲	3		SPINDLE COLD F/B-1100 SERIES	000801-25	671262025683
680783▲	3		SPINDLE HOT F/ETERNA CARTRIDGE	000811-25	671262025751
680784▲	3		SPINDLE COLD F/ETERNA CARTRIDGE	000812-25	671262025775
680785▲	3		PRE RINSE SPRING BODY	000821-40	671262025812
680786▲	3		PRE RINSE OVER HEAD SPRING	000888-45	671262026208
680840▲	1		LIVE SWIVEL FOR PRE-RINCE SPRAY VALVES	018200-40	671262756006
680842▲	1		3/8" COMP. CHECK VALVE ASSEMBLY FXM	016419-25	671262671811
680787▲	3		SPINDLE ASSY COLD F/ETERNA	002711-40	671262040433
680788	3		SPINDLE ASSY HOT F/ETERNA	002712-40	671262040457
680789▲	3		SPRAY VALVE BONNET ASSY	002856-40	671262040914
680792▲	3		SWIVEL GOOSENECK	133X	671262098496
680793▲	3		METERING CARTRIDGE PUSH BUTTON	238AB	671262762601
680796▲	3		1/2" INSTALLATION KIT	B-0230-K	671262545723
680803▲	200		STEM-COLD	002713-40	671262040471
680804▲	200		STEM-HOT	002714-40	671262040495
680808▲	200		REPAIR PARTS KIT	B-10K	671262008327
680841▲	1		GLASS FILLER REPAIR KIT	B-1256	671262719704
680797▲	1		1/2" REPAIR KIT FOR B0969 VACUUM BREAKER	TB0969RK01	671262175234
680810▲	3		LEVER HDL HOT	001637-45	671262033510
680745▲	1		LEVER HANDLE KIT HOT AND COLD PAIR	TB9K	671262014304
680811▲	200		BARREL-HOT	000788-20	671262025454
680812▲	200		BARREL-COLD	000789-20	671262025478
680809▲	1		3" OR 3-1/2" WASTE VALVE REPAIR KIT	B-39K	671262253956

SECTION 5 • PAGE 82





Fit-All Pop-Up Plungers

Fits most brands of pop-up lavatory drains.

STOCK#	PACK	CASE	DESCRIPTION	UPC#
102931▲	6	72	POLISHED BRASS	054374106318
102937▲	6	72	CHROME PLATED	054374105632
102938▲	6	72	BRUSHED NICKEL	054374158270



Fit-All Pop-Up Flanges

Fits most brands of pop-up assemblies.

STOCK#	PACK	CASE	DESCRIPTION	UPC#
102942▲	6	144	CHROME PLATED	054374106318



Delta® Pop-Up Plunger

Fits Delta® and Peerless® pop-up assemblies.

STOCK#	PACK	CASE	DESCRIPTION	MFG#	UPC#
132921	6	72	CHROME PLATED	RP5648	054374094790



Kohler® Pop-Up Plungers

Fits Coralais, Trend, Fairfax, Forte and Devonshire lavatory faucets. Chrome plated.

STOCK#	PACK	CASE	DESCRIPTION	MFG#	UPC#
132926	3	96	WITH O-RING	GP99B3254	650531630537



Fits most Kohler drains. Chrome plated.

132927	3	96	WITH PLASTIC STEM	GP1037021-CP	650531802736
--------	---	----	-------------------	--------------	--------------



Moen® Pop-Up Plunger

Extra large head to fit most Moen® pop-up drains.

STOCK#	PACK	CASE	DESCRIPTION	MFG#	UPC#
132938	6	72	EXTRA LARGE	10709	054374105885



Moen® Pop-Up Rod Assembly

Includes pivot rod and clip.

STOCK#	PACK	CASE	DESCRIPTION	MFG#	UPC#
132936	6	72	PIVOT ROD AND CLIP	12689	054374110025



Pfister® Pop-Up Arm Assembly

Includes 6" ball rod, cap and retainer clip. Will adapt to most pop-up assemblies.

STOCK#	PACK	CASE	DESCRIPTION	MFG#	UPC#
132915	6	72	ARM ASSEMBLY	941-652	054374100965
102915▲	6	72	ARM ASSEMBLY-GENERIC		054374007165
129627	12	144	NUT ONLY-BAGGED	941-410	054374077335



SECTION 5 • PAGE 84

Pfister® Pop-Up Rod Assembly

Includes upper and lower rod, thumb set screw, chrome knob and lower retainer clip. Will adapt to most pop-up assemblies.



STOCK#	PACK	CASE	DESCRIPTION	MFG#	UPC#
132916	6	72	ROD ASSEMBLY	51-270A-530-551-660	054374100972
102916▲	6	72	ROD ASSEMBLY		054374007172
129628▲	12	144	CLIP ONLY-BAGGED	941-660	054374077342

Pfister® Plastic Plungers

Fits new style pop-up drain assembly.



STOCK#	PACK	CASE	DESCRIPTION	MFG#	UPC#
132918	6	72	CHROME PLATED	S72-691A	054374094783
102918	6	72	CHROME PLATED	GENERIC	054374007196

Fit All Kitchen Faucet Pull-Out Spouts

Fits most pull-out faucets. Including American Standard®, Delta®, Eljer®, Gerber®, Kohler®, Moen®, Sterling®, Valley®, and most Italian and Asian Imports.



STOCK#	PACK	CASE	DESCRIPTION	MFG#	UPC#
100356▲	12		CHROME		054374105205
100358▲	12		WHITE		054374105212

Fits most pull-out faucets.



STOCK#	PACK	CASE	DESCRIPTION	MFG#	UPC#
100326	1	12	STAINLESS STEEL		054374656158
100357	6		WHITE		054374137596

Fit-All Pull-Out Hose

Hose for American Standard®, Delta®, Eljer®, Gerber®, Kohler®, Moen®, Pfister®, Sterling®, Valley®, and most Italian and Asian Imports.



STOCK#	PACK	CASE	DESCRIPTION	MFG#	UPC#
100309▲	6		CHROME		054374122790

Kohler® Simplice® Pull-Down Spray Head

Fits Simplice® kitchen sink faucets.



STOCK#	PACK	CASE	DESCRIPTION	MFG#	UPC#
132909	1	3	1.8 GPM VIBRANT STAINLESS	GP1043211-VS	885612018182

Kohler® Pull-Out Hose

For kitchen sink pull-out faucets and some deck mounted hand showers.



STOCK#	PACK	CASE	DESCRIPTION	MFG#	UPC#
130313	3	42	POLISHED CHROME	GP78825-CP	650531630742



Sink Sprays and Hoses

Complete with spray head and nylon reinforced 48' hose. Deluxe perforated nozzle for no-splash spray. Includes a brass adapter for old style faucets.



Fit All Sink Spray Head with 4 foot Hose

STOCK#	PACK	CASE	DESCRIPTION	UPC#
100305▲	6		SPRAY HEAD AND HOSE - BLACK	054374001873
100306	1	6	SINK SPRAY AND HOSE WHITE	054374276684



Fit All Sink Spray Hose

48" nylon reinforced hose. Includes brass adapter for old style faucets.

STOCK#	PACK	CASE	DESCRIPTION	UPC#
100303▲	6		4' HOSE	054374001859



Fit All Sink Spray Heads

Deluxe perforated nozzle for no-splash spray. Fit all sink spray hoses.

STOCK#	PACK	CASE	DESCRIPTION	UPC#
100304▲	6	72	BLACK	054374001866
100308▲	6	72	WHITE	054374105069
100312▲	1	12	STAINLESS STEEL	054374615827



Hose Guide

Fits through sink hole and provides a guide for spray hoses.

STOCK#	PACK	CASE	DESCRIPTION	UPC#
100307▲	6	144	CHROME PLATED	054374042609
110307▲	12		CHROME PLATED-Professional Pack	Bag of 2 054374666478



Water Saving Aerators for Lavatory Faucets

Watersense™ and Cal Green California Standards Compliant, these aerators have a consistent flow rate of 1.2 gallons per minute using pressure compensating technology. This saves up to 40% more water over existing 2.0 and 2.2 gallon per minute lavatory faucets. Available in chrome plated, brushed nickel, and polished brass PVD finishes.



3/4" - 27 Female Thread

STOCK#	PK	CS	DESCRIPTION	UPC#
103131	6	144	1.2 GPM - CHROME	054374861323



13/16" - 24 Female Thread

STOCK#	PK	CS	DESCRIPTION	UPC#
103132	6	144	1.2 GPM - CHROME	054374613236



55/64" - 27 Female Thread

STOCK#	PK	CS	DESCRIPTION	UPC#
103134	6	144	1.2 GPM - CHROME	054374132379
103135	6	144	1.2 GPM - BR. NICKEL	054374323791
103136	6	144	1.2 GPM - POL. BRASS	054374237913



13/16" - 27 Male Thread

STOCK#	PK	CS	DESCRIPTION	UPC#
103137	6	144	1.2 GPM - CHROME	054374379132
103138	6	144	1.2 GPM - BR. NICKEL	054374791323



15/16" - 27 x 55/64" - 27 Dual Male/Female Thread

STOCK#	PK	CS	DESCRIPTION	UPC#
103139	6	144	1.2 GPM - CHROME	054374913237
103140	6	144	1.2 GPM - BR. NICKEL	054374132386
103141	6	144	1.2 GPM - POL. BRASS	054374323869

Water Saving Aerators for Kitchen Faucets

Cal Green California Standards Compliant, these aerators have a consistent flow rate of 1.8 gallons per minute using pressure compensating technology. This saves up to 20% more water without sacrificing performance. Available in chrome plated, brushed nickel, and polished brass PVD finishes.



3/4" - 27 Female Thread

STOCK#	PK	CS	DESCRIPTION	UPC#
103143	6	144	1.8 GPM - CHROME	054374238699



13/16" - 24 Female Thread

STOCK#	PK	CS	DESCRIPTION	UPC#
103144	6	144	1.8 GPM - CHROME	054374386994



Water Saving Aerators for Kitchen Faucets *(Cont.)*

Cal Green California Standards Compliant, these aerators have a consistent flow rate of 1.8 gallons per minute using pressure compensating technology. This saves up to 20% more water without sacrificing performance. Available in chrome plated, brushed nickel, and polished brass PVD finishes.



55/64" - 27 Female Thread

STOCK#	PK	CS	DESCRIPTION	UPC#
103145	6	144	1.8 GPM - CHROME	054374572403
103147	6	144	1.8 GPM - BR. NICKEL	054374869947
103148	6	144	1.8 GPM - POL. BRASS	054374699476

13/16" - 27 Male Thread

STOCK#	PK	CS	DESCRIPTION	UPC#
103149	6	144	1.8 GPM - CHROME	054374994762
103150	6	144	1.8 GPM - BR. NICKEL	054374947621



15/16" - 27 x 55/64" - 27 Dual Male/Female Thread

STOCK#	PK	CS	DESCRIPTION	UPC#
103146	6	144	1.8 GPM - CHROME	054374724031
103154	6	144	1.8 GPM - BRUSHED NICKEL	054374476213
103155	6	144	1.8 GPM - POLISHED BRASS	054374762132

Lincoln offers a full assortment of aerators to fit all types of faucets. In addition to standard male and female aerators, you may also choose from a full selection of swivel and universal-fit styles. Other flow rates and styles.



3/4" - 27 Female Thread

STOCK#	PK	CS	DESCRIPTION	UPC#
103153	6	144	1.5 GPM - CHROME	054374557240
103102	6	144	2.0 GPM - CHROME	054374007370

13/16" - 24 Female Thread

STOCK#	PK	CS	DESCRIPTION	UPC#
103104	6	144	2.0 GPM - CHROME	054374007394



55/64" - 27 Female Thread

STOCK#	PK	CS	DESCRIPTION	UPC#
103163	6	144	0.5 GPM - CHROME	054374640034
103174	6	144	1.0 GPM - CHROME	054374662265
103129	6	144	1.5 GPM - CHROME	054374970889
103114	6	144	2.0 GPM - CHROME	054374007486

13/16" - 27 Male Thread

STOCK#	PK	CS	DESCRIPTION	UPC#
103152	6	144	1.5 GPM - CHROME	054374655724
103108	6	144	2.0 GPM - CHROME	054374007431

Lincoln offers a full assortment of aerators to fit all types of faucets. In addition to standard male and female aerators, you may also choose from a full selection of hidden swivel and universal-fit styles. Other flow rates and styles.



Caché Hidden Aerators - Standard Size

Threads directly (and disappears) into the faucet spout, making it vandal proof. 15/16" x 25/64" (M24x1).

STOCK#	PK	CS	DESCRIPTION	UPC#
100038	6	144	0.5 GPM SPRAY	054374682027
100040	6	144	1.2 GPM PERLATOR®	054374820276
103190	6	144	1.5 GPM-CHROME	054374031993
100042	6	144	1.8 GPM PERLATOR®	054374202768
100052	6	144	STANDARD KEY M24X1	054374699889



Caché Hidden Aerators - Junior Size

Threads directly (and disappears) into the faucet spout, making it vandal proof. M21.5 x 1

STOCK#	PK	CS	DESCRIPTION	UPC#
100044	6	144	0.5 GPM SPRAY	054374027699
100046	6	144	1.2 GPM PERLATOR®	054374276998
100048	6	144	1.8 GPM PERLATOR®	054374769988
100054	6	144	CACHE JUNIOR KEY M21.5X1	054374998890



Caché Hidden Aerators - Tiny Junior Size

Threads directly (and disappears) into the faucet spout, making it vandal proof. M18.5 x 1

STOCK#	PK	CS	DESCRIPTION	UPC#
100060	6	144	0.5 GPM SPRAY	054374890750
100062	6	144	1.2 GPM PERLATOR®	054374907502
100064	6	144	1.8 GPM PERLATOR®	054374078653
100056	6	144	TINY JUNIOR KEY M18.5X1	054374988907



Caché Hidden Aerators - Tom Thumb Size

Threads directly (and disappears) into the faucet spout, making it vandal proof. M16.5 x 1

STOCK#	PK	CS	DESCRIPTION	UPC#
100066	6	144	0.5 GPM SPRAY	054374786534
100068	6	144	1.2 GPM PERLATOR®	054374865345
100070	6	144	1.8 GPM PERLATOR®	054374653454
100058	6	144	TOM THUMB KEY M16.5X1	054374889075



Caché Delta & Moen Sleeves

With washer. Delta sleeve use with standard size insert. Moen sleeve use with a junior size insert.

STOCK#	PK	CS	DESCRIPTION	UPC#
100072	6	144	13/16"-27 - DELTA	054374534548
100074	6	144	M21.5X1.5 - MOEN	054374345489



Hose Thread Aerator

3/4" FHT. Adapts to spout with standard hose threads.

STOCK#	PK	CS	DESCRIPTION	UPC#
103106	6	144	2.0 GPM - CHROME	054374007417



Lincoln offers a full assortment of aerators to fit all types of faucets. In addition to standard male and female aerators, you may also choose from a full selection of hidden swivel and universal-fit styles. Other flow rates and styles.



15/16" - 27 Male Thread

STOCK#	PK	CS	DESCRIPTION	UPC#
103173	6	72	1.0 GPM - CHROME	054374088966
133172	6	72	1.0 GPM - BRUSHED NICKEL	054374153985
103151	6	144	1.5 GPM - CHROME	054374941605
103103	6	144	2.0 GPM - CHROME	054374007387

15/16" - 27 x 55/64" - 27 Dual Male/Female Thread

STOCK#	PK	CS	DESCRIPTION	UPC#
103164	6	144	0.5 GPM - CHROME	054374400348
103171	6	144	1.0 GPM - CHROME VANDAL PROOF	054374303199
103117	6	144	1.5 GPM - CHROME	054374668403
103101	6	144	2.0 GPM - CHROME	054374007363
103127	6	72	2.0 GPM - CHROME - 12-PACK	054374197088
103122	6	144	2.0 GPM - POLISHED BRASS	054374007523



Swivel Aerators

55/64"-27 female thread and 15/16"-27 male thread. Fits most spouts.

STOCK#	PK	CS	DESCRIPTION	UPC#
103197	6	72	1.5 GPM ON-OFF SWIVEL AERATOR - BLACK/CHROME	054374403196
103195	6	72	2.0 GPM SWIVEL SPRAY AERATOR - WHITE/CHROME	054374107216
103196	6	72	2.0 GPM DOUBLE SWIVEL WITH SPRAY AERATOR - WHITE/CHROME	054374010714
103115	6	72	2.0 GPM DELUXE 3-WAY SWIVEL - CLEAR PLASTIC/CHROME	054374007493
103187	6	144	2.2 GPM SWIVEL AERATOR - CHROME	054374501052
103112	6	144	2.2 GPM SWIVEL SPRAY AERATOR - WHITE/CHROME	054374007462



Chicago® Aerator

Softflo 13/16" – 24 thread.

STOCK#	PK	CS	DESCRIPTION	MFG#	UPC#
133180	6	144	1.5 GPM – POLISHED CHROME	E35JKABCP	611943578381



Dual Flow Spray Aerator

55/64"-27 female thread and 15/16"-27 male thread.

Fits most spouts.

STOCK#	PK	CS	DESCRIPTION	UPC#
103198	6	72	DUAL FLOW 0.5 GPM & 2.2 GPM - BLACK/CHROME	054374240319

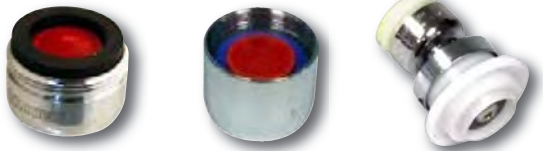

Moen® Aerators

Male 15/16"-27 thread to fit Moen® lavatory faucets.

STOCK#	PK	CS	DESCRIPTION	MFG#	UPC#
133119	6	144	2.2 GPM - CHROME	3919	054374105823

Female 55/64"-27 thread to fit Moen® kitchen faucets.

STOCK#	PK	CS	DESCRIPTION	MFG#	UPC#
133120	6	144	2.2 GPM - CHROME	3924	054374105830

Swing-N-Spray. Switches from full spray to aerated spray with a pull or push of the the plastic housing. Full 360° action with either spray. 55/64"-27 female thread and 15/16"-27 male thread. Fits most spouts.

STOCK#	PK	CS	DESCRIPTION	MFG#	UPC#
133113	6	72	2.2 GPM - CP BRASS/ PLASTIC	20200	054374068203



Delta® Aerators

Male 15/16" thread to fit Delta® kitchen and lavatory faucets.

STOCK#	PK	CS	DESCRIPTION	MFG#	UPC#
133130	6	144	2.2 GPM - POL. CHROME	RP330	054374100989

"Spray Round" swivel aerator with 55/64"-27 female thread and 15/16"-27 male thread to fit Delta® kitchen faucets.

STOCK#	PK	CS	DESCRIPTION	MFG#	UPC#
133133	6	72	CP BRASS/PLASTIC	RP63137	054374751945

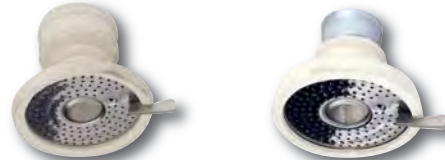

Faucet Queen

STOCK#	PK	CS	DESCRIPTION	UPC#
103110▲	6	48	RUBBER SPRAY - SNAP-ON	054374007448

55/64"-27 female thread and 15/16"-27 male threads

103111▲	6	48	RUBBER SPRAY - THREADED	054374007455
---------	---	----	-------------------------	--------------



PROFLO® Aerators

15/16" (23.8mm) MIP x 55/64" (21.8mm) FIP. Patented three-screen slotted design provides a splash-free stream. Tube of 6.

STOCK#	PK	CS	DESCRIPTION	MFG#	UPC#
113174	12	72	2.2 GPM - CHROME	PFX113174	781889223550



Aerator Repair Parts and Adapters

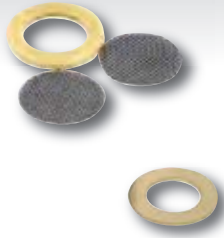

Aerator Repair Kit

Stainless steel aerator screen with rubber washer fits most aerators for a quick repair or an extra screen.

STOCK#	PACK	CASE	DESCRIPTION	TRADE#	UPC#
103002▲	6	144	REPAIR KIT		054374007271
128616▲	12	144	AERATOR SCREEN ONLY - 2 PER BAG	EW-204E	054374681891
128618	12	144	AERATOR WASHER ONLY - 2 PER BAG	EW-204A	054374818914

Aerator Adapters

To help overcome those unusual and unexpected situations, Lincoln offers a full range of aerator adapters. All of these adapters convert faucet spouts to accommodate standard female aerators (55/64" - 27 thread) unless otherwise specified.



Combination Adapter

Dual thread adapts to standard male or female threaded faucet spout. Middle section threaded faucet spout. Middle section threaded for 3/4" hose, lower section adapts to standard female aerator (15/16").

STOCK#	PACK	CASE	DESCRIPTION	TRADE#	UPC#
103003▲	6	144	COMBINATION ADAPTER		054374007288



Faucet to Hose Thread Adapter

Adapts from standard male or female spout thread to male hose thread.

STOCK#	PACK	CASE	DESCRIPTION	TRADE#	UPC#
103019▲	6	144	DUAL THREAD		054374127979

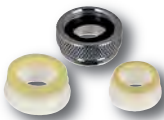

Adapter Assortment

Consists of our 3 most popular adapters: one male 15/16"-27 thread, one male 13/16"-27 thread and one female 3/4"-27 thread..

STOCK#	PACK	CASE	DESCRIPTION	TRADE#	UPC#
103016▲	6	144	3-PIECE ASSORTMENT		054374375707



Male Adapters

15/16"-27 threaded adapter. Fits Delta® and American Standard®. Adapts to standard female aerator.

STOCK#	PACK	CASE	DESCRIPTION	TRADE#	UPC#
103000▲	6	144	MALE ADAPTER		054374537570

13/16"-27 male thread fits Pfister® wall mount and Kohler®. Adapts to standard aerator.

STOCK#	PACK	CASE	DESCRIPTION	TRADE#	UPC#
103013	6	144	MALE ADAPTER		054374323913

11/16"-27 male thread fits Chicago® faucet. Adapts to standard female aerator.

STOCK#	PACK	CASE	DESCRIPTION	TRADE#	UPC#
103018	6	144	CHICAGO MALE AERATOR ADAPTER		054374310517



Aerator Adapters and Snap Fittings



Female Adapters

3/4" - 27 female thread fits Pfister® and Kohler® deck faucet spouts. Adapts to standard female aerator.

STOCK#	PACK	CASE	DESCRIPTION	TRADE#	UPC#
103012▲	6	144	FEMALE ADAPTER		054374622269



Hose Adapters

Fits hose thread faucet and provides male thread to accommodate standard female aerator.

STOCK#	PACK	CASE	DESCRIPTION	TRADE#	UPC#
103006▲	6	144	HOSE TO AERATOR ADAPTER		054374007318

Dishwasher Snap Nipples



Snap Nipple

Adapts to General Electric® and Westinghouse® dishwashers. Internal screen for aerated flow when not using dishwasher. 55/64"-27 female thread and 15/16"-27 male thread. Fits most spouts.

STOCK#	PACK	CASE	DESCRIPTION	UPC#
103300▲	6	144	SNAP NIPPLE	054374216345



Deluxe Snap Nipple

Contains internal deluxe aerator for smooth full flow.

STOCK#	PACK	CASE	DESCRIPTION	UPC#
103302▲	6	144	DELUXE SNAP NIPPLE	054374163618



Long Dishwasher Snap Nipple

55/64" - 27 female thread. Fits Sears® portable dishwashers.

STOCK#	PACK	CASE	DESCRIPTION	UPC#
103304	6	144	SNAP NIPPLE WITH AERATOR	054374361816



Snap Coupler Set

Dual thread snap nipple adapts to standard faucet spouts. Snap coupler has 1/2" male threads which accommodates a personal shower hose. Ideal for removable shampoo unit.

STOCK#	PACK	CASE	DESCRIPTION	UPC#
103311▲	6	144	SNAP COUPLER SET 1/2" IPS	054374618



Proposition 65 Warnings

Below is a listing of all items that come with a Proposition 65 Warning. All eligible items are in numerical order.

STOCK#	WARNING	CHEMICAL
100101	<!> WARNING: Cancer and Reproductive Harm - www.P65warnings.ca.gov	
100109	<!> WARNING: Cancer and Reproductive Harm www.p65warnings.ca.gov	LEAD AND LEAD COMPOUNDS
100112	<!> WARNING: Reproductive Harm - www.P65warnings.ca.gov	
100113	<!> WARNING: Reproductive Harm - www.P65warnings.ca.gov	
100114	<!> WARNING: Reproductive Harm - www.P65warnings.ca.gov	
100115	<!> WARNING: Reproductive Harm - www.P65warnings.ca.gov	
100116	<!> WARNING: Reproductive Harm - www.P65warnings.ca.gov	
100117	<!> WARNING: Reproductive Harm - www.P65warnings.ca.gov	
100118	<!> WARNING: Reproductive Harm - www.P65warnings.ca.gov	
100119	<!> WARNING: Cancer and Reproductive Harm - www.P65warnings.ca.gov	LEAD AND LEAD COMPOUNDS
100150	<!> WARNING: Cancer and Reproductive Harm - www.P65warnings.ca.gov	CARBON BLACK
100160	<!> WARNING: Cancer and Reproductive Harm - www.P65warnings.ca.gov	CARBON BLACK
100170	<!> WARNING: Cancer and Reproductive Harm - www.P65warnings.ca.gov	LEAD AND LEAD COMPOUNDS
100181	<!> WARNING: Cancer - www.P65warnings.ca.gov	
100190	<!> WARNING: Cancer and Reproductive Harm - www.P65warnings.ca.gov	
100303	<!> WARNING: Cancer and Reproductive Harm - www.P65warnings.ca.gov	
100304	<!> WARNING: Cancer and Reproductive Harm - www.P65warnings.ca.gov	
100305	<!> WARNING: Cancer and Reproductive Harm - www.P65warnings.ca.gov	
100307	<!> WARNING: Cancer and Reproductive Harm - www.P65warnings.ca.gov	1 3-BUTADIENE; STYRENE
100308	<!> WARNING: Cancer and Reproductive Harm - www.P65warnings.ca.gov	
100309	<!> WARNING: Cancer and Reproductive Harm - www.P65warnings.ca.gov	CARBON BLACK; LEAD AND LEAD COMPOUNDS
100311	<!> WARNING: Cancer and Reproductive Harm - www.P65warnings.ca.gov	
100312	<!> WARNING: Cancer and Reproductive Harm - www.P65warnings.ca.gov	
100330	<!> WARNING: Cancer and Reproductive Harm - www.P65warnings.ca.gov	
100356	<!> WARNING: Cancer and Reproductive Harm - www.P65warnings.ca.gov	1 3-BUTADIENE; CHROMIUM (HEXAVALENT COMPOUNDS); STYRENE
100358	<!> WARNING: Cancer - www.P65warnings.ca.gov	
100401	<!> WARNING: Cancer and Reproductive Harm - www.P65warnings.ca.gov	LEAD



▲ For **Proposition 65** warnings please refer to pages 93-124 at the end of this section.

All Products Used for Potable Water are:



Proposition 65 Warnings

Below is a listing of all items that come with a Proposition 65 Warning. All eligible items are in numerical order.

SECTION 5 • PAGE 94

STOCK#	WARNING	CHEMICAL
100403	<!> WARNING: Cancer and Reproductive Harm - www.P65warnings.ca.gov	CARBON BLACK; CHROMIUM (HEXAVALENT COMPOUNDS); LEAD AND LEAD COMPOUNDS
100409	<!> WARNING: Cancer and Reproductive Harm - www.P65warnings.ca.gov	CARBON BLACK; CHROMIUM (HEXAVALENT COMPOUNDS); LEAD AND LEAD COMPOUNDS
100411	<!> WARNING: Cancer and Reproductive Harm - www.P65warnings.ca.gov	CARBON BLACK; CHROMIUM (HEXAVALENT COMPOUNDS); LEAD AND LEAD COMPOUNDS
100414	<!> WARNING: Cancer - www.P65warnings.ca.gov	
100415	<!> WARNING: Cancer and Reproductive Harm - www.P65warnings.ca.gov	CARBON BLACK; CHROMIUM (HEXAVALENT COMPOUNDS); LEAD AND LEAD COMPOUNDS
100416	<!> WARNING: Cancer and Reproductive Harm - www.P65warnings.ca.gov	CARBON BLACK; CHROMIUM (HEXAVALENT COMPOUNDS); LEAD AND LEAD COMPOUNDS
100418	<!> WARNING: Cancer - www.P65warnings.ca.gov	
100420	<!> WARNING: Cancer and Reproductive Harm - www.P65warnings.ca.gov	CARBON BLACK; CHROMIUM (HEXAVALENT COMPOUNDS); LEAD AND LEAD COMPOUNDS
100421	<!> WARNING: Cancer - www.P65warnings.ca.gov	
100429	<!> WARNING: Cancer and Reproductive Harm - www.P65warnings.ca.gov	LEAD
100430	<!> WARNING: Cancer and Reproductive Harm - www.P65warnings.ca.gov	LEAD
100448	<!> WARNING: Cancer and Reproductive Harm - www.P65warnings.ca.gov	LEAD
100451	<!> WARNING: Cancer and Reproductive Harm - www.P65warnings.ca.gov	LEAD
100459	<!> WARNING: Cancer and Reproductive Harm - www.P65warnings.ca.gov	CARBON BLACK; CHROMIUM (HEXAVALENT COMPOUNDS); LEAD AND LEAD COMPOUNDS
100461	<!> WARNING: Cancer and Reproductive Harm - www.P65warnings.ca.gov	CARBON BLACK; CHROMIUM (HEXAVALENT COMPOUNDS); LEAD AND LEAD COMPOUNDS
100463	<!> WARNING: Cancer and Reproductive Harm - www.P65warnings.ca.gov	LEAD
100464	<!> WARNING: Cancer - www.P65warnings.ca.gov	



▲ For **Proposition 65** warnings please refer to pages 93-124 at the end of this section.

All Products Used for Potable Water are:



Proposition 65 Warnings

Below is a listing of all items that come with a Proposition 65 Warning. All eligible items are in numerical order.

STOCK#	WARNING	CHEMICAL
100465	<!> WARNING: Cancer and Reproductive Harm - www.P65warnings.ca.gov	CARBON BLACK; CHROMIUM (HEXAVALENT COMPOUNDS); LEAD AND LEAD COMPOUNDS
100466	<!> WARNING: Cancer and Reproductive Harm - www.P65warnings.ca.gov	CARBON BLACK; CHROMIUM (HEXAVALENT COMPOUNDS); LEAD AND LEAD COMPOUNDS
100468	<!> WARNING: Cancer - www.P65warnings.ca.gov	
100470	<!> WARNING: Cancer and Reproductive Harm - www.P65warnings.ca.gov	CARBON BLACK; CHROMIUM (HEXAVALENT COMPOUNDS); LEAD AND LEAD COMPOUNDS
100471	<!> WARNING: Cancer - www.P65warnings.ca.gov	
100480	<!> WARNING: Cancer and Reproductive Harm - www.P65warnings.ca.gov	LEAD
100483	<!> WARNING: Cancer and Reproductive Harm - www.P65warnings.ca.gov	LEAD
100484	<!> WARNING: Cancer and Reproductive Harm - www.P65warnings.ca.gov	LEAD
100487	<!> WARNING: Cancer and Reproductive Harm - www.P65warnings.ca.gov	LEAD
100489	<!> WARNING: Cancer and Reproductive Harm - www.P65warnings.ca.gov	LEAD
100490	<!> WARNING: Cancer and Reproductive Harm - www.P65warnings.ca.gov	LEAD
101101	<!> WARNING: Cancer - www.P65warnings.ca.gov	
101108	<!> WARNING: Cancer and Reproductive Harm - www.P65warnings.ca.gov	
101109	<!> WARNING: Cancer - www.P65warnings.ca.gov	
101112	<!> WARNING: Reproductive Harm - www.P65warnings.ca.gov	BUTYL BENZYL PHTHALATE
101119	<!> WARNING: Cancer and Reproductive Harm - www.P65warnings.ca.gov	
101122	<!> WARNING: Cancer and Reproductive Harm - www.P65warnings.ca.gov	LEAD
101140	<!> WARNING: Reproductive Harm - www.P65warnings.ca.gov	
101145	<!> WARNING: Cancer and Reproductive Harm - www.P65warnings.ca.gov	LEAD
101150	<!> WARNING: Cancer and Reproductive Harm - www.P65warnings.ca.gov	LEAD AND LEAD COMPOUNDS
101155	<!> WARNING: Cancer and Reproductive Harm - www.P65warnings.ca.gov	LEAD
101161	<!> WARNING: Reproductive Harm - www.P65warnings.ca.gov	BUTYL BENZYL PHTHALATE
101190	<!> WARNING: Reproductive Harm - www.P65warnings.ca.gov	
101191	<!> WARNING: Reproductive Harm - www.P65warnings.ca.gov	
101192	<!> WARNING: Cancer and Reproductive Harm - www.P65warnings.ca.gov	

Proposition 65 Warnings

Below is a listing of all items that come with a Proposition 65 Warning. All eligible items are in numerical order.

STOCK#	WARNING	CHEMICAL
101222	<!> WARNING: Cancer and Reproductive Harm - www.P65warnings.ca.gov	CARBON BLACK; CHROMIUM (HEXAVALENT COMPOUNDS); LEAD AND LEAD COMPOUNDS
101225	<!> WARNING: Reproductive Harm - www.P65warnings.ca.gov	BUTYL BENZYL PHTHALATE
101229	<!> WARNING: Cancer and Reproductive Harm - www.P65warnings.ca.gov	CARBON BLACK; CHROMIUM (HEXAVALENT COMPOUNDS); LEAD AND LEAD COMPOUNDS
101231	<!> WARNING: Cancer and Reproductive Harm - www.P65warnings.ca.gov	LEAD
101240	<!> WARNING: Reproductive Harm - www.P65warnings.ca.gov	BUTYL BENZYL PHTHALATE
101255	<!> WARNING: Cancer and Reproductive Harm - www.P65warnings.ca.gov	
101262	<!> WARNING: Cancer and Reproductive Harm - www.P65warnings.ca.gov	POLYPHENYL ETHER
101274	<!> WARNING: Cancer and Reproductive Harm - www.P65warnings.ca.gov	CARBON BLACK; CHROMIUM (HEXAVALENT COMPOUNDS); LEAD AND LEAD COMPOUNDS
101281	<!> WARNING: Cancer and Reproductive Harm - www.P65warnings.ca.gov	LEAD
101290	<!> WARNING: Reproductive Harm - www.P65warnings.ca.gov	BUTYL BENZYL PHTHALATE
101333	<!> WARNING: Cancer and Reproductive Harm - www.P65warnings.ca.gov	CHROMIUM (HEXAVALENT COMPOUNDS); DI(2-ETHYLHEXYL) PHTHALATE (DEHP); LEAD AND LEAD COMPOUNDS; NICKEL (METALLIC)
101383	<!> WARNING: Cancer and Reproductive Harm - www.P65warnings.ca.gov	CHROMIUM (HEXAVALENT COMPOUNDS); DI(2-ETHYLHEXYL) PHTHALATE (DEHP); LEAD AND LEAD COMPOUNDS; NICKEL (METALLIC)
101394	<!> WARNING: Cancer and Reproductive Harm - www.P65warnings.ca.gov	DI(2-ETHYLHEXYL) PHTHALATE (DEHP); LEAD AND LEAD COMPOUNDS; NICKEL (METALLIC)
101395	<!> WARNING: Cancer and Reproductive Harm - www.P65warnings.ca.gov	CHROMIUM (HEXAVALENT COMPOUNDS)
101403	<!> WARNING: Cancer and Reproductive Harm - www.P65warnings.ca.gov	ACRYLAMIDE; CHROMIUM (HEXAVALENT COMPOUNDS); DI(2-ETHYLHEXYL) PHTHALATE (DEHP); LEAD AND LEAD COMPOUNDS; NICKEL (METALLIC)

SECTION 5 • PAGE 96



▲ For **Proposition 65** warnings please refer to pages 93-124 at the end of this section.

All Products Used for Potable Water are:



Proposition 65 Warnings

Below is a listing of all items that come with a Proposition 65 Warning. All eligible items are in numerical order.

STOCK#	WARNING	CHEMICAL
101405	<I> WARNING: Cancer and Reproductive Harm - www.P65warnings.ca.gov	CHROMIUM (HEXAVALENT COMPOUNDS); DI(2-ETHYLHEXYL) PHTHALATE (DEHP); LEAD
101409	<I> WARNING: Cancer and Reproductive Harm - www.P65warnings.ca.gov	1 3-BUTADIENE; ACRYLAMIDE; LEAD AND LEAD COMPOUNDS; STYRENE
101430	<I> WARNING: Cancer and Reproductive Harm - www.P65warnings.ca.gov	LEAD AND LEAD COMPOUNDS; NICKEL (METALLIC)
101431	<I> WARNING: Cancer and Reproductive Harm - www.P65warnings.ca.gov	CHROMIUM (HEXAVALENT COMPOUNDS); LEAD AND LEAD COMPOUNDS; NICKEL (METALLIC)
101432	<I> WARNING: Cancer and Reproductive Harm - www.P65warnings.ca.gov	CHROMIUM (HEXAVALENT COMPOUNDS); LEAD AND LEAD COMPOUNDS; NICKEL (METALLIC)
101433	<I> WARNING: Cancer and Reproductive Harm - www.P65warnings.ca.gov	CHROMIUM (HEXAVALENT COMPOUNDS); LEAD AND LEAD COMPOUNDS; NICKEL (METALLIC)
101434	<I> WARNING: Cancer and Reproductive Harm - www.P65warnings.ca.gov	ACRYLAMIDE; CHROMIUM (HEXAVALENT COMPOUNDS); LEAD AND LEAD COMPOUNDS
101436	<I> WARNING: Cancer and Reproductive Harm - www.P65warnings.ca.gov	DI (2-ETHYLHEXYL) PHTHALATE (DEHP)
101437	<I> WARNING: Cancer and Reproductive Harm - www.P65warnings.ca.gov	ACRYLAMIDE
101443	<I> WARNING: Cancer and Reproductive Harm - www.P65warnings.ca.gov	CHROMIUM (HEXAVALENT COMPOUNDS); LEAD AND LEAD COMPOUNDS; NICKEL (METALLIC)
101445	<I> WARNING: Cancer and Reproductive Harm - www.P65warnings.ca.gov	
101453	<I> WARNING: Cancer and Reproductive Harm - www.P65warnings.ca.gov	CHROMIUM (HEXAVALENT COMPOUNDS); LEAD AND LEAD COMPOUNDS; NICKEL (METALLIC)
101455	<I> WARNING: Cancer and Reproductive Harm - www.P65warnings.ca.gov	CHROMIUM (HEXAVALENT COMPOUNDS); DI(2-ETHYLHEXYL) PHTHALATE (DEHP); LEAD
101474	<I> WARNING: Cancer and Reproductive Harm - www.P65warnings.ca.gov	



▲ For **Proposition 65** warnings please refer to pages 93-124 at the end of this section.

All Products Used for Potable Water are:



Proposition 65 Warnings

Below is a listing of all items that come with a Proposition 65 Warning. All eligible items are In numerical order.

STOCK#	WARNING	CHEMICAL
101476	<I> WARNING: Cancer and Reproductive Harm - www.P65warnings.ca.gov	DI(2-ETHYLHEXYL) PHTHALATE (DEHP); NICKEL (METALLIC)
101477	<I> WARNING: Cancer and Reproductive Harm - www.P65warnings.ca.gov	DI(2-ETHYLHEXYL) PHTHALATE (DEHP); NICKEL (METALLIC)
101482	<I> WARNING: Cancer and Reproductive Harm - www.P65warnings.ca.gov	CHROMIUM (HEXAVALENT COMPOUNDS); LEAD AND LEAD COMPOUNDS; NICKEL (METALLIC)
101483	<I> WARNING: Cancer and Reproductive Harm - www.P65warnings.ca.gov	CHROMIUM (HEXAVALENT COMPOUNDS); LEAD AND LEAD COMPOUNDS; NICKEL (METALLIC)
101484	<I> WARNING: Cancer and Reproductive Harm - www.P65warnings.ca.gov	ACRYLAMIDE; CHROMIUM (HEXAVALENT COMPOUNDS); LEAD AND LEAD COMPOUNDS; NICKEL (METALLIC)
101486	<I> WARNING: Cancer and Reproductive Harm - www.P65warnings.ca.gov	ACRYLAMIDE; CHROMIUM (HEXAVALENT COMPOUNDS); LEAD AND LEAD COMPOUNDS; NICKEL (METALLIC)
101487	<I> WARNING: Cancer and Reproductive Harm - www.P65warnings.ca.gov	ACRYLAMIDE; CHROMIUM (HEXAVALENT COMPOUNDS); LEAD AND LEAD COMPOUNDS; NICKEL (METALLIC)
101493	<I> WARNING: Cancer and Reproductive Harm - www.P65warnings.ca.gov	1 3-BUTADIENE; ACRYLAMIDE; LEAD AND LEAD COMPOUNDS; STYRENE
101494	<I> WARNING: Cancer and Reproductive Harm - www.P65warnings.ca.gov	CHROMIUM (HEXAVALENT COMPOUNDS); LEAD AND LEAD COMPOUNDS; NICKEL (METALLIC); STYRENE
101496	<I> WARNING: Cancer and Reproductive Harm - www.P65warnings.ca.gov	CHROMIUM (HEXAVALENT COMPOUNDS); LEAD AND LEAD COMPOUNDS; NICKEL (METALLIC); STYRENE
101498	<I> WARNING: Cancer and Reproductive Harm - www.P65warnings.ca.gov	ACRYLAMIDE
101499	<I> WARNING: Cancer and Reproductive Harm - www.P65warnings.ca.gov	1 3-BUTADIENE; ACRYLAMIDE; LEAD AND LEAD COMPOUNDS; STYRENE

SECTION 5 • PAGE 98



▲ For **Proposition 65** warnings please refer to pages 93-124 at the end of this section.

All Products Used for Potable Water are:



Proposition 65 Warnings

Below is a listing of all items that come with a Proposition 65 Warning. All eligible items are in numerical order.

STOCK#	WARNING	CHEMICAL
101626	<!> WARNING: Cancer and Reproductive Harm - www.P65warnings.ca.gov	LEAD
101632	<!> WARNING: Cancer and Reproductive Harm - www.P65warnings.ca.gov	LEAD
101633	<!> WARNING: Cancer and Reproductive Harm - www.P65warnings.ca.gov	LEAD
101637	<!> WARNING: Cancer and Reproductive Harm - www.P65warnings.ca.gov	LEAD
101641	<!> WARNING: Cancer and Reproductive Harm - www.P65warnings.ca.gov	LEAD
101643	<!> WARNING: Cancer and Reproductive Harm - www.P65warnings.ca.gov	LEAD
101645	<!> WARNING: Cancer and Reproductive Harm - www.P65warnings.ca.gov	LEAD
101650	<!> WARNING: Cancer and Reproductive Harm - www.P65warnings.ca.gov	POLYPHENYL ETHER
101651	<!> WARNING: Cancer and Reproductive Harm - www.P65warnings.ca.gov	POLYPHENYL ETHER
101655	<!> WARNING: Cancer and Reproductive Harm - www.P65warnings.ca.gov	DI(2-ETHYLHEXYL) PHTHALATE (DEHP); LEAD AND LEAD COMPOUNDS
101656	<!> WARNING: Cancer and Reproductive Harm - www.P65warnings.ca.gov	DI (2-ETHYLHEXYL) PHTHALATE (DEHP); LEAD AND LEAD COMPOUNDS
101657	<!> WARNING: Cancer - www.P65warnings.ca.gov	
101660	<!> WARNING: Cancer and Reproductive Harm - www.P65warnings.ca.gov	POLYPHENYL ETHER
101676	<!> WARNING: Cancer and Reproductive Harm - www.P65warnings.ca.gov	LEAD
101677	<!> WARNING: Cancer and Reproductive Harm - www.P65warnings.ca.gov	LEAD
101680	<!> WARNING: Cancer and Reproductive Harm - www.P65warnings.ca.gov	LEAD
101682	<!> WARNING: Cancer and Reproductive Harm - www.P65warnings.ca.gov	LEAD
101683	<!> WARNING: Cancer and Reproductive Harm - www.P65warnings.ca.gov	LEAD
101687	<!> WARNING: Cancer and Reproductive Harm - www.P65warnings.ca.gov	LEAD
101691	<!> WARNING: Cancer and Reproductive Harm - www.P65warnings.ca.gov	LEAD
101693	<!> WARNING: Cancer and Reproductive Harm - www.P65warnings.ca.gov	LEAD
101695	<!> WARNING: Cancer and Reproductive Harm - www.P65warnings.ca.gov	LEAD
101800	<!> WARNING: Cancer and Reproductive Harm - www.P65warnings.ca.gov	1 3-BUTADIENE; STYRENE
101821	<!> WARNING: Cancer and Reproductive Harm - www.P65warnings.ca.gov	CHROMIUM (HEXAVALENT COMPOUNDS); LEAD AND LEAD COMPOUNDS; NICKEL (METALLIC); STYRENE
101823	<!> WARNING: Cancer and Reproductive Harm - www.P65warnings.ca.gov	1 3-BUTADIENE; ACRYLAMIDE; LEAD AND LEAD COMPOUNDS; STYRENE



▲ For **Proposition 65** warnings please refer to pages 93-124 at the end of this section.

All Products Used for Potable Water are:



Proposition 65 Warnings

Below is a listing of all items that come with a Proposition 65 Warning. All eligible items are In numerical order.

SECTION 5 • PAGE 100

STOCK#	WARNING	CHEMICAL	
101825	<I> WARNING: Cancer and Reproductive Harm - www.P65warnings.ca.gov	CHROMIUM (HEXAVALENT COMPOUNDS); LEAD AND LEAD COMPOUNDS; NICKEL (METALLIC); STYRENE	
101871	<I> WARNING: Cancer and Reproductive Harm - www.P65warnings.ca.gov	CARBON BLACK; CHROMIUM (HEXAVALENT COMPOUNDS); LEAD AND LEAD COMPOUNDS	
101875	<I> WARNING: Cancer and Reproductive Harm - www.P65warnings.ca.gov	CARBON BLACK; CHROMIUM (HEXAVALENT COMPOUNDS); LEAD AND LEAD COMPOUNDS	
101879	<I> WARNING: Cancer and Reproductive Harm - www.P65warnings.ca.gov	CARBON BLACK; CHROMIUM (HEXAVALENT COMPOUNDS); LEAD AND LEAD COMPOUNDS	
101881	<I> WARNING: Cancer and Reproductive Harm - www.P65warnings.ca.gov	CARBON BLACK; CHROMIUM (HEXAVALENT COMPOUNDS); LEAD AND LEAD COMPOUNDS	
102207	<I> WARNING: Cancer and Reproductive Harm - www.P65warnings.ca.gov		
102211	<I> WARNING: Cancer and Reproductive Harm - www.P65warnings.ca.gov		
102212	<I> WARNING: Cancer and Reproductive Harm - www.P65warnings.ca.gov	DI(2-ETHYLHEXYL) PHTHALATE (DEHP)	
STOCK#	WARNING	CHEMICAL	CAS1
102213	<I> WARNING: Cancer and Reproductive Harm - www.P65warnings.ca.gov	CHROMIUM (HEXAVALENT COMPOUNDS); DI(2-ETHYLHEXYL) PHTHALATE (DEHP); NICKEL (METALLIC)	117-81-7
102214	<I> WARNING: Cancer and Reproductive Harm - www.P65warnings.ca.gov	CHROMIUM (HEXAVALENT COMPOUNDS); DI(2-ETHYLHEXYL) PHTHALATE (DEHP); NICKEL (METALLIC)	117-81-7
102215	<I> WARNING: Cancer and Reproductive Harm - www.P65warnings.ca.gov	CHROMIUM (HEXAVALENT COMPOUNDS); DI(2-ETHYLHEXYL) PHTHALATE (DEHP); NICKEL (METALLIC)	117-81-7
102216	<I> WARNING: Cancer and Reproductive Harm - www.P65warnings.ca.gov	CHROMIUM (HEXAVALENT COMPOUNDS); DI(2-ETHYLHEXYL) PHTHALATE (DEHP); NICKEL (METALLIC)	117-81-7



▲ For **Proposition 65** warnings please refer to pages 93-124 at the end of this section.

All Products Used for Potable Water are:



Proposition 65 Warnings

Below is a listing of all items that come with a Proposition 65 Warning. All eligible items are in numerical order.

STOCK#	WARNING	CHEMICAL
102219	<!> WARNING: Cancer and Reproductive Harm - www.P65warnings.ca.gov	CHROMIUM (HEXAVALENT COMPOUNDS); DI(2-ETHYLHEXYL) PHTHALATE (DEHP); LEAD AND LEAD COMPOUNDS; NICKEL (METALLIC)
102222	<!> WARNING: Cancer and Reproductive Harm - www.P65warnings.ca.gov	LEAD AND LEAD COMPOUNDS; NICKEL (METALLIC)
102240	<!> WARNING: Cancer and Reproductive Harm - www.P65warnings.ca.gov	CHROMIUM (HEXAVALENT COMPOUNDS); LEAD AND LEAD COMPOUNDS; NICKEL (METALLIC)
102254	<!> WARNING: Cancer and Reproductive Harm - www.P65warnings.ca.gov	CARBON BLACK; DIISONONYL PHTHALATE (DINP); LEAD AND LEAD COMPOUNDS; NICKEL (METALLIC)
102270	<!> WARNING: Cancer and Reproductive Harm - www.P65warnings.ca.gov	CHROMIUM (HEXAVALENT COMPOUNDS); LEAD AND LEAD COMPOUNDS; NICKEL (METALLIC); STYRENE
102272	<!> WARNING: Cancer and Reproductive Harm - www.P65warnings.ca.gov	1 3-BUTADIENE; ACRYLAMIDE; LEAD AND LEAD COMPOUNDS; STYRENE
102273	<!> WARNING: Cancer and Reproductive Harm - www.P65warnings.ca.gov	CARBON BLACK; LEAD AND LEAD COMPOUNDS; NICKEL (METALLIC)
102280	<!> WARNING: Cancer and Reproductive Harm - www.P65warnings.ca.gov	CARBON BLACK; DIISONONYL PHTHALATE (DINP); LEAD AND LEAD COMPOUNDS; NICKEL (METALLIC)
102285	<!> WARNING: Cancer and Reproductive Harm - www.P65warnings.ca.gov	1 3-BUTADIENE; ACRYLAMIDE; CARBON BLACK; CHROMIUM (HEXAVALENT COMPOUNDS); DIISONONYL PHTHALATE (DINP)
102286	<!> WARNING: Cancer and Reproductive Harm - www.P65warnings.ca.gov	1 3-BUTADIENE; ACRYLAMIDE; CARBON BLACK; CHROMIUM (HEXAVALENT COMPOUNDS); DIISONONYL PHTHALATE (DINP)



▲ For **Proposition 65** warnings please refer to pages 93-124 at the end of this section.

All Products Used for Potable Water are:



Proposition 65 Warnings

Below is a listing of all items that come with a Proposition 65 Warning. All eligible items are in numerical order.

SECTION 5 • PAGE 102

STOCK#	WARNING	CHEMICAL	CAS1
102290	<I> WARNING: Cancer and Reproductive Harm - www.P65warnings.ca.gov	1 3-BUTADIENE; ACRYLAMIDE; CARBON BLACK; CHROMIUM (HEXAVALENT COMPOUNDS); DIISONONYL PHTHALATE (DINP)	79-06-1
102291	<I> WARNING: Cancer and Reproductive Harm - www.P65warnings.ca.gov	1 3-BUTADIENE; ACRYLAMIDE; CARBON BLACK; CHROMIUM (HEXAVALENT COMPOUNDS); DIISONONYL PHTHALATE (DINP)	79-06-1
STOCK#	WARNING	CHEMICAL	
102306	<I> WARNING: Cancer and Reproductive Harm - www.P65warnings.ca.gov	CARBON BLACK; CHROMIUM (HEXAVALENT COMPOUNDS); LEAD AND LEAD COMPOUNDS	
102308	<I> WARNING: Cancer and Reproductive Harm - www.P65warnings.ca.gov	CARBON BLACK; CHROMIUM (HEXAVALENT COMPOUNDS); LEAD AND LEAD COMPOUNDS	
102310	<I> WARNING: Cancer and Reproductive Harm - www.P65warnings.ca.gov	CARBON BLACK; CHROMIUM (HEXAVALENT COMPOUNDS); LEAD AND LEAD COMPOUNDS	
102311	<I> WARNING: Cancer and Reproductive Harm - www.P65warnings.ca.gov		
102313	<I> WARNING: Cancer and Reproductive Harm - www.P65warnings.ca.gov		
102314	<I> WARNING: Cancer and Reproductive Harm - www.P65warnings.ca.gov		
102315	<I> WARNING: Cancer - www.P65warnings.ca.gov		
102317	<I> WARNING: Cancer and Reproductive Harm - www.P65warnings.ca.gov		
102318	<I> WARNING: Cancer and Reproductive Harm - www.P65warnings.ca.gov		
102323	<I> WARNING: Cancer and Reproductive Harm - www.P65warnings.ca.gov		
102324	<I> WARNING: Cancer and Reproductive Harm - www.P65warnings.ca.gov	CARBON BLACK; CHROMIUM (HEXAVALENT COMPOUNDS); LEAD AND LEAD COMPOUNDS	
102326	<I> WARNING: Cancer and Reproductive Harm - www.P65warnings.ca.gov	CARBON BLACK; CHROMIUM (HEXAVALENT COMPOUNDS); LEAD AND LEAD COMPOUNDS	



▲ For **Proposition 65** warnings please refer to pages 93-124 at the end of this section.

All Products Used for Potable Water are:



Proposition 65 Warnings

Below is a listing of all items that come with a Proposition 65 Warning. All eligible items are in numerical order.

STOCK#	WARNING	CHEMICAL	
102330	<!> WARNING: Cancer and Reproductive Harm - www.P65warnings.ca.gov		
102331	<!> WARNING: Cancer and Reproductive Harm - www.P65warnings.ca.gov		
102332	<!> WARNING: Cancer and Reproductive Harm - www.P65warnings.ca.gov		
102344	<!> WARNING: Cancer and Reproductive Harm - www.P65warnings.ca.gov		
102355	<!> WARNING: Reproductive Harm - www.P65warnings.ca.gov	BUTYL BENZYL PHTHALATE	
102356	<!> WARNING: Cancer and Reproductive Harm - www.P65warnings.ca.gov	LEAD	
102362	<!> WARNING: Cancer and Reproductive Harm - www.P65warnings.ca.gov		
102368	<!> WARNING: Cancer and Reproductive Harm - www.P65warnings.ca.gov		
102404	<!> WARNING: Cancer and Reproductive Harm - www.P65warnings.ca.gov	CARBON BLACK; CHROMIUM (HEXAVALENT COMPOUNDS); LEAD AND LEAD COMPOUNDS	
102409	<!> WARNING: Cancer and Reproductive Harm - www.P65warnings.ca.gov	LEAD	
102410	<!> WARNING: Cancer and Reproductive Harm - www.P65warnings.ca.gov	CARBON BLACK; CHROMIUM (HEXAVALENT COMPOUNDS); LEAD AND LEAD COMPOUNDS	
STOCK#	WARNING	CHEMICAL	CAS1
102412	<!> WARNING: Cancer and Reproductive Harm - www.P65warnings.ca.gov	LEAD	7439-92-1
102413	<!> WARNING: Cancer and Reproductive Harm - www.P65warnings.ca.gov	LEAD	7439-92-1
STOCK#	WARNING	CHEMICAL	
102417	<!> WARNING: Cancer and Reproductive Harm - www.P65warnings.ca.gov	CARBON BLACK; CHROMIUM (HEXAVALENT COMPOUNDS); LEAD AND LEAD COMPOUNDS	
102418	<!> WARNING: Cancer and Reproductive Harm - www.P65warnings.ca.gov	CARBON BLACK; CHROMIUM (HEXAVALENT COMPOUNDS); LEAD AND LEAD COMPOUNDS	
102422	<!> WARNING: Cancer and Reproductive Harm - www.P65warnings.ca.gov	CARBON BLACK; CHROMIUM (HEXAVALENT COMPOUNDS); LEAD AND LEAD COMPOUNDS	
102433	<!> WARNING: Cancer and Reproductive Harm - www.P65warnings.ca.gov	CARBON BLACK; CHROMIUM (HEXAVALENT COMPOUNDS); LEAD AND LEAD COMPOUNDS	
102434	<!> WARNING: Cancer and Reproductive Harm - www.P65warnings.ca.gov	LEAD	

SECTION 5 • PAGE 103



▲ For **Proposition 65** warnings please refer to pages 93-124 at the end of this section.

All Products Used for Potable Water are:



Proposition 65 Warnings

Below is a listing of all items that come with a Proposition 65 Warning. All eligible items are in numerical order.

STOCK#	WARNING	CHEMICAL
102435	<!> WARNING: Cancer and Reproductive Harm - www.P65warnings.ca.gov	CARBON BLACK; CHROMIUM (HEXAVALENT COMPOUNDS); LEAD AND LEAD COMPOUNDS
102436	<!> WARNING: Cancer and Reproductive Harm - www.P65warnings.ca.gov	LEAD
102453	<!> WARNING: Cancer and Reproductive Harm - www.P65warnings.ca.gov	CARBON BLACK; CHROMIUM (HEXAVALENT COMPOUNDS); LEAD AND LEAD COMPOUNDS
102461	<!> WARNING: Cancer and Reproductive Harm - www.P65warnings.ca.gov	CARBON BLACK; CHROMIUM (HEXAVALENT COMPOUNDS); LEAD AND LEAD COMPOUNDS
102462	<!> WARNING: Cancer and Reproductive Harm - www.P65warnings.ca.gov	CARBON BLACK; CHROMIUM (HEXAVALENT COMPOUNDS); LEAD AND LEAD COMPOUNDS
102915	<!> WARNING: Cancer and Reproductive Harm - www.P65warnings.ca.gov	CARBON BLACK; CHROMIUM (HEXAVALENT COMPOUNDS); LEAD AND LEAD COMPOUNDS
102916	<!> WARNING: Cancer and Reproductive Harm - www.P65warnings.ca.gov	LEAD AND LEAD COMPOUNDS; NICKEL (METALLIC)
102918	<!> WARNING: Cancer and Reproductive Harm - www.P65warnings.ca.gov	CHROMIUM (HEXAVALENT COMPOUNDS); LEAD AND LEAD COMPOUNDS; STYRENE
102931	<!> WARNING: Cancer and Reproductive Harm - www.P65warnings.ca.gov	1 3-BUTADIENE; NICKEL (METALLIC); STYRENE
102937	<!> WARNING: Cancer and Reproductive Harm - www.P65warnings.ca.gov	1 3-BUTADIENE; NICKEL (METALLIC); STYRENE
102938	<!> WARNING: Cancer and Reproductive Harm - www.P65warnings.ca.gov	1 3-BUTADIENE; NICKEL (METALLIC); STYRENE
102942	<!> WARNING: Cancer and Reproductive Harm - www.P65warnings.ca.gov	CHROMIUM (HEXAVALENT COMPOUNDS); LEAD AND LEAD COMPOUNDS
103000	<!> WARNING: Cancer and Reproductive Harm - www.P65warnings.ca.gov	CARBON BLACK; CHROMIUM (HEXAVALENT COMPOUNDS); LEAD AND LEAD COMPOUNDS
103002	<!> WARNING: Cancer and Reproductive Harm - www.P65warnings.ca.gov	LEAD AND LEAD COMPOUNDS; NICKEL (METALLIC)

SECTION 5 • PAGE 104



▲ For **Proposition 65** warnings please refer to pages 93-124 at the end of this section.

All Products Used for Potable Water are:



Proposition 65 Warnings

Below is a listing of all items that come with a Proposition 65 Warning. All eligible items are in numerical order.

STOCK#	WARNING	CHEMICAL
103003	<!> WARNING: Cancer and Reproductive Harm - www.P65warnings.ca.gov	CARBON BLACK; CHROMIUM (HEXAVALENT COMPOUNDS); LEAD AND LEAD COMPOUNDS
103006	<!> WARNING: Cancer and Reproductive Harm - www.P65warnings.ca.gov	CARBON BLACK; CHROMIUM (HEXAVALENT COMPOUNDS); LEAD AND LEAD COMPOUNDS
103012	<!> WARNING: Cancer and Reproductive Harm - www.P65warnings.ca.gov	CARBON BLACK; CHROMIUM (HEXAVALENT COMPOUNDS); LEAD AND LEAD COMPOUNDS
103016	<!> WARNING: Cancer and Reproductive Harm - www.P65warnings.ca.gov	CARBON BLACK; CHROMIUM (HEXAVALENT COMPOUNDS); LEAD AND LEAD COMPOUNDS
103019	<!> WARNING: Cancer and Reproductive Harm - www.P65warnings.ca.gov	CARBON BLACK; CHROMIUM (HEXAVALENT COMPOUNDS); LEAD AND LEAD COMPOUNDS
103025	<!> WARNING: Cancer and Reproductive Harm - www.P65warnings.ca.gov	CARBON BLACK; CHROMIUM (HEXAVALENT COMPOUNDS); LEAD AND LEAD COMPOUNDS
103102	<!> WARNING: Cancer and Reproductive Harm - www.P65warnings.ca.gov	CARBON BLACK; CHROMIUM (HEXAVALENT COMPOUNDS); LEAD AND LEAD COMPOUNDS
103104	<!> WARNING: Cancer and Reproductive Harm - www.P65warnings.ca.gov	CARBON BLACK; CHROMIUM (HEXAVALENT COMPOUNDS); LEAD AND LEAD COMPOUNDS
103106	<!> WARNING: Cancer and Reproductive Harm - www.P65warnings.ca.gov	CARBON BLACK; CHROMIUM (HEXAVALENT COMPOUNDS); LEAD AND LEAD COMPOUNDS
103110	<!> WARNING: Cancer and Reproductive Harm - www.P65warnings.ca.gov	1 3-BUTADIENE; LEAD AND LEAD COMPOUNDS; NICKEL (METALLIC); STYRENE
103111	<!> WARNING: Cancer and Reproductive Harm - www.P65warnings.ca.gov	1 3-BUTADIENE; LEAD AND LEAD COMPOUNDS; NICKEL (METALLIC); STYRENE

SECTION 5 • PAGE 105



▲ For **Proposition 65** warnings please refer to pages 93-124 at the end of this section.

All Products Used for Potable Water are:



Proposition 65 Warnings

Below is a listing of all items that come with a Proposition 65 Warning. All eligible items are In numerical order.

SECTION 5 • PAGE 106

STOCK#	WARNING	CHEMICAL	
103122	<I> WARNING: Cancer and Reproductive Harm - www.P65warnings.ca.gov	CARBON BLACK; CHROMIUM (HEXAVALENT COMPOUNDS); LEAD AND LEAD COMPOUNDS	
103300	<I> WARNING: Cancer and Reproductive Harm - www.P65warnings.ca.gov	LEAD AND LEAD COMPOUNDS; NICKEL (METALLIC)	
103302	<I> WARNING: Cancer and Reproductive Harm - www.P65warnings.ca.gov	CARBON BLACK; CHROMIUM (HEXAVALENT COMPOUNDS); LEAD AND LEAD COMPOUNDS	
103311	<I> WARNING: Cancer and Reproductive Harm - www.P65warnings.ca.gov	CARBON BLACK; CHROMIUM (HEXAVALENT COMPOUNDS); LEAD AND LEAD COMPOUNDS	
109434	<I> WARNING: Cancer and Reproductive Harm - www.P65warnings.ca.gov	CARBON BLACK; CHROMIUM (HEXAVALENT COMPOUNDS); LEAD AND LEAD COMPOUNDS	
STOCK#	WARNING	CHEMICAL	CAS1
110109	<I> WARNING: Cancer and Reproductive Harm - www.P65warnings.ca.gov	CARBON BLACK; LEAD AND LEAD COMPOUNDS	1333-86-4
110119	<I> WARNING: Cancer and Reproductive Harm - www.P65warnings.ca.gov	CARBON BLACK; CHROMIUM (HEXAVALENT COMPOUNDS); LEAD AND LEAD COMPOUNDS	1333-86-4
STOCK#	WARNING	CHEMICAL	
110122	<I> WARNING: Cancer and Reproductive Harm - www.P65warnings.ca.gov	CARBON BLACK; CHROMIUM (HEXAVALENT COMPOUNDS); LEAD AND LEAD COMPOUNDS	
110123	<I> WARNING: Cancer and Reproductive Harm - www.P65warnings.ca.gov		
110126	<I> WARNING: Cancer and Reproductive Harm - www.P65warnings.ca.gov	CARBON BLACK; CHROMIUM (HEXAVALENT COMPOUNDS); LEAD AND LEAD COMPOUNDS	
STOCK#	WARNING	CHEMICAL	CAS1
110160	<I> WARNING: Cancer and Reproductive Harm - www.P65warnings.ca.gov	CARBON BLACK; DIISONONYL PHTHALATE (DINP); LEAD AND LEAD COMPOUNDS	1333-86-4
110500	<I> WARNING: Cancer and Reproductive Harm - www.P65warnings.ca.gov	LEAD	7439-92-1



▲ For **Proposition 65** warnings please refer to pages 93-124 at the end of this section.

All Products Used for Potable Water are:



Proposition 65 Warnings

Below is a listing of all items that come with a Proposition 65 Warning. All eligible items are in numerical order.

STOCK#	WARNING	CHEMICAL	CAS1
111146	<I> WARNING: Cancer and Reproductive Harm - www.P65warnings.ca.gov	LEAD	
111813	<I> WARNING: Cancer and Reproductive Harm - www.P65warnings.ca.gov	CARBON BLACK; CHROMIUM (HEXAVALENT COMPOUNDS); LEAD AND LEAD COMPOUNDS	1333-86-4
111814	<I> WARNING: Cancer and Reproductive Harm - www.P65warnings.ca.gov	CARBON BLACK; CHROMIUM (HEXAVALENT COMPOUNDS); LEAD AND LEAD COMPOUNDS	1333-86-4
111815	<I> WARNING: Cancer and Reproductive Harm - www.P65warnings.ca.gov	CARBON BLACK; CHROMIUM (HEXAVALENT COMPOUNDS); LEAD AND LEAD COMPOUNDS	1333-86-4
111816	<I> WARNING: Cancer and Reproductive Harm - www.P65warnings.ca.gov	CARBON BLACK; CHROMIUM (HEXAVALENT COMPOUNDS); LEAD AND LEAD COMPOUNDS	1333-86-4
111817	<I> WARNING: Cancer and Reproductive Harm - www.P65warnings.ca.gov		
111818	<I> WARNING: Cancer and Reproductive Harm - www.P65warnings.ca.gov		
111819	<I> WARNING: Cancer and Reproductive Harm - www.P65warnings.ca.gov	CARBON BLACK; CHROMIUM (HEXAVALENT COMPOUNDS); LEAD AND LEAD COMPOUNDS	1333-86-4
111821	<I> WARNING: Cancer and Reproductive Harm - www.P65warnings.ca.gov	CARBON BLACK; CHROMIUM (HEXAVALENT COMPOUNDS); LEAD AND LEAD COMPOUNDS	1333-86-4
111824	<I> WARNING: Cancer and Reproductive Harm - www.P65warnings.ca.gov	CARBON BLACK; CHROMIUM (HEXAVALENT COMPOUNDS); LEAD AND LEAD COMPOUNDS	1333-86-4
111825	<I> WARNING: Cancer and Reproductive Harm - www.P65warnings.ca.gov	CARBON BLACK; CHROMIUM (HEXAVALENT COMPOUNDS); LEAD AND LEAD COMPOUNDS	1333-86-4
111826	<I> WARNING: Cancer and Reproductive Harm - www.P65warnings.ca.gov	CARBON BLACK; CHROMIUM (HEXAVALENT COMPOUNDS); LEAD AND LEAD COMPOUNDS	1333-86-4
111827	<I> WARNING: Cancer and Reproductive Harm - www.P65warnings.ca.gov	CARBON BLACK; CHROMIUM (HEXAVALENT COMPOUNDS); LEAD AND LEAD COMPOUNDS	1333-86-4

SECTION 5 • PAGE 107



▲ For **Proposition 65** warnings please refer to pages 93-124 at the end of this section.

All Products Used for Potable Water are:



Proposition 65 Warnings

Below is a listing of all items that come with a Proposition 65 Warning. All eligible items are in numerical order.

STOCK#	WARNING	CHEMICAL	CAS1
111828	<I> WARNING: Cancer and Reproductive Harm - www.P65warnings.ca.gov	CARBON BLACK; CHROMIUM (HEXAVALENT COMPOUNDS); LEAD AND LEAD COMPOUNDS	1333-86-4
111829	<I> WARNING: Cancer and Reproductive Harm - www.P65warnings.ca.gov	CARBON BLACK; CHROMIUM (HEXAVALENT COMPOUNDS); LEAD AND LEAD COMPOUNDS	1333-86-4
111830	<I> WARNING: Cancer and Reproductive Harm - www.P65warnings.ca.gov	CARBON BLACK; CHROMIUM (HEXAVALENT COMPOUNDS); LEAD AND LEAD COMPOUNDS	1333-86-4
111831	<I> WARNING: Cancer and Reproductive Harm - www.P65warnings.ca.gov	CARBON BLACK; CHROMIUM (HEXAVALENT COMPOUNDS); LEAD AND LEAD COMPOUNDS	1333-86-4
111832	<I> WARNING: Cancer and Reproductive Harm - www.P65warnings.ca.gov	CARBON BLACK; CHROMIUM (HEXAVALENT COMPOUNDS); LEAD AND LEAD COMPOUNDS	1333-86-4
111833	<I> WARNING: Cancer and Reproductive Harm - www.P65warnings.ca.gov	CARBON BLACK; CHROMIUM (HEXAVALENT COMPOUNDS); LEAD AND LEAD COMPOUNDS	1333-86-4
111834	<I> WARNING: Cancer and Reproductive Harm - www.P65warnings.ca.gov	CARBON BLACK; CHROMIUM (HEXAVALENT COMPOUNDS); LEAD AND LEAD COMPOUNDS	1333-86-4
111835	<I> WARNING: Cancer and Reproductive Harm - www.P65warnings.ca.gov	CARBON BLACK; CHROMIUM (HEXAVALENT COMPOUNDS); LEAD AND LEAD COMPOUNDS	1333-86-4
111836	<I> WARNING: Cancer and Reproductive Harm - www.P65warnings.ca.gov	CARBON BLACK; CHROMIUM (HEXAVALENT COMPOUNDS); LEAD AND LEAD COMPOUNDS	
111837	<I> WARNING: Cancer and Reproductive Harm - www.P65warnings.ca.gov		
111838	<I> WARNING: Cancer and Reproductive Harm - www.P65warnings.ca.gov		
111839	<I> WARNING: Cancer and Reproductive Harm - www.P65warnings.ca.gov	CARBON BLACK; CHROMIUM (HEXAVALENT COMPOUNDS); LEAD AND LEAD COMPOUNDS	1333-86-4

SECTION 5 • PAGE 108



▲ For **Proposition 65** warnings please refer to pages 93-124 at the end of this section.

All Products Used for Potable Water are:



Proposition 65 Warnings

Below is a listing of all items that come with a Proposition 65 Warning. All eligible items are in numerical order.

STOCK#	WARNING	CHEMICAL	CAS1
111840	<!> WARNING: Cancer and Reproductive Harm - www.P65warnings.ca.gov	CARBON BLACK; CHROMIUM (HEXAVALENT COMPOUNDS); LEAD AND LEAD COMPOUNDS	1333-86-4
111841	<!> WARNING: Cancer and Reproductive Harm - www.P65warnings.ca.gov	CARBON BLACK; CHROMIUM (HEXAVALENT COMPOUNDS); LEAD AND LEAD COMPOUNDS	1333-86-4
111842	<!> WARNING: Cancer and Reproductive Harm - www.P65warnings.ca.gov	CARBON BLACK; CHROMIUM (HEXAVALENT COMPOUNDS); LEAD AND LEAD COMPOUNDS	1333-86-4
111843	<!> WARNING: Cancer and Reproductive Harm - www.P65warnings.ca.gov	CARBON BLACK; CHROMIUM (HEXAVALENT COMPOUNDS); LEAD AND LEAD COMPOUNDS	1333-86-4
111844	<!> WARNING: Cancer and Reproductive Harm - www.P65warnings.ca.gov	CARBON BLACK; CHROMIUM (HEXAVALENT COMPOUNDS); LEAD AND LEAD COMPOUNDS	1333-86-4
111845	<!> WARNING: Cancer and Reproductive Harm - www.P65warnings.ca.gov	CARBON BLACK; CHROMIUM (HEXAVALENT COMPOUNDS); LEAD AND LEAD COMPOUNDS	1333-86-4
111846	<!> WARNING: Cancer and Reproductive Harm - www.P65warnings.ca.gov		
111847	<!> WARNING: Cancer and Reproductive Harm - www.P65warnings.ca.gov		
111848	<!> WARNING: Cancer and Reproductive Harm - www.P65warnings.ca.gov		
111849	<!> WARNING: Cancer and Reproductive Harm - www.P65warnings.ca.gov	CARBON BLACK; CHROMIUM (HEXAVALENT COMPOUNDS); LEAD AND LEAD COMPOUNDS	1333-86-4
111850	<!> WARNING: Cancer and Reproductive Harm - www.P65warnings.ca.gov	CARBON BLACK; CHROMIUM (HEXAVALENT COMPOUNDS); LEAD AND LEAD COMPOUNDS	1333-86-4
111851	<!> WARNING: Cancer and Reproductive Harm - www.P65warnings.ca.gov	CARBON BLACK; CHROMIUM (HEXAVALENT COMPOUNDS); LEAD AND LEAD COMPOUNDS	1333-86-4
111852	<!> WARNING: Cancer and Reproductive Harm - www.P65warnings.ca.gov		

SECTION 5 • PAGE 109



▲ For **Proposition 65** warnings please refer to pages 93-124 at the end of this section.

All Products Used for Potable Water are:



Proposition 65 Warnings

Below is a listing of all items that come with a Proposition 65 Warning. All eligible items are in numerical order.

SECTION 5 • PAGE 110

STOCK#	WARNING	CHEMICAL	CAS1
111853	<I> WARNING: Cancer and Reproductive Harm - www.P65warnings.ca.gov	CARBON BLACK; CHROMIUM (HEXAVALENT COMPOUNDS); LEAD AND LEAD COMPOUNDS	1333-86-4
111854	<I> WARNING: Cancer and Reproductive Harm - www.P65warnings.ca.gov	CARBON BLACK; CHROMIUM (HEXAVALENT COMPOUNDS); LEAD AND LEAD COMPOUNDS	1333-86-4
111855	<I> WARNING: Cancer and Reproductive Harm - www.P65warnings.ca.gov	CARBON BLACK; CHROMIUM (HEXAVALENT COMPOUNDS); LEAD AND LEAD COMPOUNDS	1333-86-4
111856	<I> WARNING: Cancer and Reproductive Harm - www.P65warnings.ca.gov	CARBON BLACK; CHROMIUM (HEXAVALENT COMPOUNDS); LEAD AND LEAD COMPOUNDS	1333-86-4
111857	<I> WARNING: Cancer and Reproductive Harm - www.P65warnings.ca.gov	CARBON BLACK; CHROMIUM (HEXAVALENT COMPOUNDS); LEAD AND LEAD COMPOUNDS	1333-86-4
111858	<I> WARNING: Cancer and Reproductive Harm - www.P65warnings.ca.gov	CARBON BLACK; CHROMIUM (HEXAVALENT COMPOUNDS); LEAD AND LEAD COMPOUNDS	1333-86-4
111859	<I> WARNING: Cancer and Reproductive Harm - www.P65warnings.ca.gov	CARBON BLACK; CHROMIUM (HEXAVALENT COMPOUNDS); LEAD AND LEAD COMPOUNDS	1333-86-4
111860	<I> WARNING: Cancer and Reproductive Harm - www.P65warnings.ca.gov		
111861	<I> WARNING: Cancer and Reproductive Harm - www.P65warnings.ca.gov	CARBON BLACK; CHROMIUM (HEXAVALENT COMPOUNDS); LEAD AND LEAD COMPOUNDS	1333-86-4
111862	<I> WARNING: Cancer and Reproductive Harm - www.P65warnings.ca.gov	CARBON BLACK; CHROMIUM (HEXAVALENT COMPOUNDS); LEAD AND LEAD COMPOUNDS	1333-86-4
111863	<I> WARNING: Cancer and Reproductive Harm - www.P65warnings.ca.gov		
111864	<I> WARNING: Cancer and Reproductive Harm - www.P65warnings.ca.gov	CARBON BLACK; CHROMIUM (HEXAVALENT COMPOUNDS); LEAD AND LEAD COMPOUNDS	1333-86-4



▲ For **Proposition 65** warnings please refer to pages 93-124 at the end of this section.

All Products Used for Potable Water are:



Proposition 65 Warnings

Below is a listing of all items that come with a Proposition 65 Warning. All eligible items are in numerical order.

STOCK#	WARNING	CHEMICAL	CAS1
111865	<!> WARNING: Cancer and Reproductive Harm - www.P65warnings.ca.gov	CARBON BLACK; CHROMIUM (HEXAVALENT COMPOUNDS); LEAD AND LEAD COMPOUNDS	1333-86-4
111866	<!> WARNING: Cancer and Reproductive Harm - www.P65warnings.ca.gov		
111867	<!> WARNING: Cancer and Reproductive Harm - www.P65warnings.ca.gov		
111868	<!> WARNING: Cancer and Reproductive Harm - www.P65warnings.ca.gov		
111869	<!> WARNING: Cancer and Reproductive Harm - www.P65warnings.ca.gov		
111870	<!> WARNING: Cancer and Reproductive Harm - www.P65warnings.ca.gov		
111871	<!> WARNING: Cancer and Reproductive Harm - www.P65warnings.ca.gov	CARBON BLACK; CHROMIUM (HEXAVALENT COMPOUNDS); LEAD AND LEAD COMPOUNDS	1333-86-4
111872	<!> WARNING: Cancer and Reproductive Harm - www.P65warnings.ca.gov		
111873	<!> WARNING: Cancer and Reproductive Harm - www.P65warnings.ca.gov	CARBON BLACK; CHROMIUM (HEXAVALENT COMPOUNDS); LEAD AND LEAD COMPOUNDS	1333-86-4
111874	<!> WARNING: Cancer and Reproductive Harm - www.P65warnings.ca.gov	CARBON BLACK; CHROMIUM (HEXAVALENT COMPOUNDS); LEAD AND LEAD COMPOUNDS	1333-86-4
111875	<!> WARNING: Cancer and Reproductive Harm - www.P65warnings.ca.gov	CARBON BLACK; CHROMIUM (HEXAVALENT COMPOUNDS); LEAD AND LEAD COMPOUNDS	1333-86-4
111876	<!> WARNING: Cancer and Reproductive Harm - www.P65warnings.ca.gov	CARBON BLACK; CHROMIUM (HEXAVALENT COMPOUNDS); LEAD AND LEAD COMPOUNDS	1333-86-4
111877	<!> WARNING: Cancer and Reproductive Harm - www.P65warnings.ca.gov	CARBON BLACK; CHROMIUM (HEXAVALENT COMPOUNDS); LEAD AND LEAD COMPOUNDS	1333-86-4
111878	<!> WARNING: Cancer and Reproductive Harm - www.P65warnings.ca.gov	CARBON BLACK; CHROMIUM (HEXAVALENT COMPOUNDS); LEAD AND LEAD COMPOUNDS	1333-86-4
111879	<!> WARNING: Cancer and Reproductive Harm - www.P65warnings.ca.gov	CARBON BLACK; CHROMIUM (HEXAVALENT COMPOUNDS); LEAD AND LEAD COMPOUNDS	1333-86-4

SECTION 5 • PAGE 111



▲ For **Proposition 65** warnings please refer to pages 93-124 at the end of this section.

All Products Used for Potable Water are:



Proposition 65 Warnings

Below is a listing of all items that come with a Proposition 65 Warning. All eligible items are in numerical order.

SECTION 5 • PAGE 112

STOCK#	WARNING	CHEMICAL	CAS1
111880	<I> WARNING: Cancer and Reproductive Harm - www.P65warnings.ca.gov	CARBON BLACK; CHROMIUM (HEXAVALENT COMPOUNDS); LEAD AND LEAD COMPOUNDS	1333-86-4
111881	<I> WARNING: Cancer and Reproductive Harm - www.P65warnings.ca.gov	CARBON BLACK; CHROMIUM (HEXAVALENT COMPOUNDS); LEAD AND LEAD COMPOUNDS	1333-86-4
111882	<I> WARNING: Cancer and Reproductive Harm - www.P65warnings.ca.gov	CARBON BLACK; CHROMIUM (HEXAVALENT COMPOUNDS); LEAD AND LEAD COMPOUNDS	1333-86-4
111883	<I> WARNING: Cancer and Reproductive Harm - www.P65warnings.ca.gov		
111884	<I> WARNING: Cancer and Reproductive Harm - www.P65warnings.ca.gov		
111885	<I> WARNING: Cancer and Reproductive Harm - www.P65warnings.ca.gov	CARBON BLACK; CHROMIUM (HEXAVALENT COMPOUNDS); LEAD AND LEAD COMPOUNDS	1333-86-4
111886	<I> WARNING: Cancer and Reproductive Harm - www.P65warnings.ca.gov	CARBON BLACK; CHROMIUM (HEXAVALENT COMPOUNDS); LEAD AND LEAD COMPOUNDS	1333-86-4
111887	<I> WARNING: Cancer and Reproductive Harm - www.P65warnings.ca.gov	CARBON BLACK; CHROMIUM (HEXAVALENT COMPOUNDS); LEAD AND LEAD COMPOUNDS	1333-86-4
111888	<I> WARNING: Cancer and Reproductive Harm - www.P65warnings.ca.gov		
111889	<I> WARNING: Cancer and Reproductive Harm - www.P65warnings.ca.gov		
111890	<I> WARNING: Cancer and Reproductive Harm - www.P65warnings.ca.gov		
111891	<I> WARNING: Cancer and Reproductive Harm - www.P65warnings.ca.gov		
111892	<I> WARNING: Cancer and Reproductive Harm - www.P65warnings.ca.gov	CARBON BLACK; CHROMIUM (HEXAVALENT COMPOUNDS); LEAD AND LEAD COMPOUNDS	1333-86-4
111893	<I> WARNING: Cancer and Reproductive Harm - www.P65warnings.ca.gov	CARBON BLACK; CHROMIUM (HEXAVALENT COMPOUNDS); LEAD AND LEAD COMPOUNDS	1333-86-4
STOCK#	WARNING	CHEMICAL	
119904	<I> WARNING: Cancer and Reproductive Harm - www.P65warnings.ca.gov	LEAD	
119906	<I> WARNING: Cancer and Reproductive Harm - www.P65warnings.ca.gov	LEAD	



▲ For **Proposition 65** warnings please refer to pages 93-124 at the end of this section.

All Products Used for Potable Water are:



Proposition 65 Warnings

Below is a listing of all items that come with a Proposition 65 Warning. All eligible items are in numerical order.

STOCK#	WARNING	CHEMICAL	
119911	<!> WARNING: Cancer and Reproductive Harm - www.P65warnings.ca.gov	LEAD	
119922	<!> WARNING: Cancer and Reproductive Harm - www.P65warnings.ca.gov	CARBON BLACK; CHROMIUM (HEXAVALENT COMPOUNDS); LEAD AND LEAD COMPOUNDS	
119925	<!> WARNING: Cancer and Reproductive Harm - www.P65warnings.ca.gov	CARBON BLACK; CHROMIUM (HEXAVALENT COMPOUNDS); LEAD AND LEAD COMPOUNDS	
119926	<!> WARNING: Cancer and Reproductive Harm - www.P65warnings.ca.gov	CARBON BLACK; CHROMIUM (HEXAVALENT COMPOUNDS); LEAD AND LEAD COMPOUNDS	
STOCK#	WARNING	CHEMICAL	CAS1
120108	<!> WARNING: Cancer and Reproductive Harm - www.P65warnings.ca.gov	LEAD	7439-92-1
STOCK#	WARNING	CHEMICAL	
120109	<!> WARNING: Cancer - www.P65warnings.ca.gov		
120122	<!> WARNING: Cancer and Reproductive Harm - www.P65warnings.ca.gov	LEAD	
120129	<!> WARNING: Cancer and Reproductive Harm - www.P65warnings.ca.gov	LEAD	
120130	<!> WARNING: Cancer and Reproductive Harm - www.P65warnings.ca.gov	LEAD	
120146	<!> WARNING: Cancer www.p65warnings.ca.gov		
120148	<!> WARNING: Cancer and Reproductive Harm - www.P65warnings.ca.gov	LEAD	
120149	<!> WARNING: Cancer - www.P65warnings.ca.gov		
120150	<!> WARNING: Cancer and Reproductive Harm - www.P65warnings.ca.gov	LEAD AND LEAD COMPOUNDS	
120151	<!> WARNING: Cancer - www.P65warnings.ca.gov		
120152	<!> WARNING: Cancer - www.P65warnings.ca.gov		
120154	<!> WARNING: Cancer - www.P65warnings.ca.gov		
120155	<!> WARNING: Cancer and Reproductive Harm - www.P65warnings.ca.gov	LEAD	
128001	<!> WARNING: Cancer and Reproductive Harm - www.P65warnings.ca.gov	CARBON BLACK	
128002	<!> WARNING: Cancer and Reproductive Harm - www.P65warnings.ca.gov	CARBON BLACK	
128003	<!> WARNING: Cancer and Reproductive Harm - www.P65warnings.ca.gov	CARBON BLACK	
128004	<!> WARNING: Cancer and Reproductive Harm - www.P65warnings.ca.gov	CARBON BLACK	
128005	<!> WARNING: Cancer and Reproductive Harm - www.P65warnings.ca.gov	CARBON BLACK	
128006	<!> WARNING: Cancer and Reproductive Harm - www.P65warnings.ca.gov	CARBON BLACK	

SECTION 5 • PAGE 113



▲ For **Proposition 65** warnings please refer to pages 93-124 at the end of this section.

All Products Used for Potable Water are:



Proposition 65 Warnings

Below is a listing of all items that come with a Proposition 65 Warning. All eligible items are In numerical order.

SECTION 5 • PAGE 114

STOCK#	WARNING	CHEMICAL
128007	<I> WARNING: Cancer and Reproductive Harm - www.P65warnings.ca.gov	CARBON BLACK
128008	<I> WARNING: Cancer and Reproductive Harm - www.P65warnings.ca.gov	CARBON BLACK
128009	<I> WARNING: Cancer and Reproductive Harm - www.P65warnings.ca.gov	CARBON BLACK
128010	<I> WARNING: Cancer and Reproductive Harm - www.P65warnings.ca.gov	CARBON BLACK
128011	<I> WARNING: Cancer and Reproductive Harm - www.P65warnings.ca.gov	CARBON BLACK
128012	<I> WARNING: Cancer and Reproductive Harm - www.P65warnings.ca.gov	CARBON BLACK
128013	<I> WARNING: Cancer and Reproductive Harm - www.P65warnings.ca.gov	CARBON BLACK
128014	<I> WARNING: Cancer and Reproductive Harm - www.P65warnings.ca.gov	CARBON BLACK
128015	<I> WARNING: Cancer and Reproductive Harm - www.P65warnings.ca.gov	CARBON BLACK
128016	<I> WARNING: Cancer and Reproductive Harm - www.P65warnings.ca.gov	CARBON BLACK
128017	<I> WARNING: Cancer and Reproductive Harm - www.P65warnings.ca.gov	CARBON BLACK
128018	<I> WARNING: Cancer and Reproductive Harm - www.P65warnings.ca.gov	CARBON BLACK
128021	<I> WARNING: Cancer and Reproductive Harm - www.P65warnings.ca.gov	CARBON BLACK
128022	<I> WARNING: Cancer and Reproductive Harm - www.P65warnings.ca.gov	CARBON BLACK
128029	<I> WARNING: Cancer and Reproductive Harm - www.P65warnings.ca.gov	CARBON BLACK
128030	<I> WARNING: Cancer and Reproductive Harm - www.P65warnings.ca.gov	CARBON BLACK
128031	<I> WARNING: Cancer and Reproductive Harm - www.P65warnings.ca.gov	CARBON BLACK
128032	<I> WARNING: Cancer and Reproductive Harm - www.P65warnings.ca.gov	CARBON BLACK
128033	<I> WARNING: Cancer and Reproductive Harm - www.P65warnings.ca.gov	CARBON BLACK
128034	<I> WARNING: Cancer and Reproductive Harm - www.P65warnings.ca.gov	CARBON BLACK
128035	<I> WARNING: Cancer and Reproductive Harm - www.P65warnings.ca.gov	CARBON BLACK
128036	<I> WARNING: Cancer and Reproductive Harm - www.P65warnings.ca.gov	CARBON BLACK
128037	<I> WARNING: Cancer and Reproductive Harm - www.P65warnings.ca.gov	CARBON BLACK
128038	<I> WARNING: Cancer and Reproductive Harm - www.P65warnings.ca.gov	CARBON BLACK
128039	<I> WARNING: Cancer and Reproductive Harm - www.P65warnings.ca.gov	CARBON BLACK
128040	<I> WARNING: Cancer and Reproductive Harm - www.P65warnings.ca.gov	CARBON BLACK
128041	<I> WARNING: Cancer and Reproductive Harm - www.P65warnings.ca.gov	CARBON BLACK
128042	<I> WARNING: Cancer and Reproductive Harm - www.P65warnings.ca.gov	CARBON BLACK
128043	<I> WARNING: Cancer and Reproductive Harm - www.P65warnings.ca.gov	CARBON BLACK
128044	<I> WARNING: Cancer and Reproductive Harm - www.P65warnings.ca.gov	CARBON BLACK
128045	<I> WARNING: Cancer and Reproductive Harm - www.P65warnings.ca.gov	CARBON BLACK



▲ For **Proposition 65** warnings please refer to pages 93-124 at the end of this section.

All Products Used for Potable Water are:



Proposition 65 Warnings

Below is a listing of all items that come with a Proposition 65 Warning. All eligible items are in numerical order.

STOCK#	WARNING	CHEMICAL
128046	<!> WARNING: Cancer and Reproductive Harm - www.P65warnings.ca.gov	CARBON BLACK
128047	<!> WARNING: Cancer and Reproductive Harm - www.P65warnings.ca.gov	CARBON BLACK
128048	<!> WARNING: Cancer and Reproductive Harm - www.P65warnings.ca.gov	CARBON BLACK
128049	<!> WARNING: Cancer and Reproductive Harm - www.P65warnings.ca.gov	CARBON BLACK
128050	<!> WARNING: Cancer and Reproductive Harm - www.P65warnings.ca.gov	CARBON BLACK
128053	<!> WARNING: Cancer and Reproductive Harm - www.P65warnings.ca.gov	CARBON BLACK
128058	<!> WARNING: Cancer and Reproductive Harm - www.P65warnings.ca.gov	CARBON BLACK
128059	<!> WARNING: Cancer and Reproductive Harm - www.P65warnings.ca.gov	CARBON BLACK
128060	<!> WARNING: Cancer and Reproductive Harm - www.P65warnings.ca.gov	CARBON BLACK
128061	<!> WARNING: Cancer and Reproductive Harm - www.P65warnings.ca.gov	CARBON BLACK
128062	<!> WARNING: Cancer and Reproductive Harm - www.P65warnings.ca.gov	CARBON BLACK
128063	<!> WARNING: Cancer and Reproductive Harm - www.P65warnings.ca.gov	CARBON BLACK
128064	<!> WARNING: Cancer and Reproductive Harm - www.P65warnings.ca.gov	CARBON BLACK
128065	<!> WARNING: Cancer and Reproductive Harm - www.P65warnings.ca.gov	CARBON BLACK
128066	<!> WARNING: Cancer and Reproductive Harm - www.P65warnings.ca.gov	CARBON BLACK
128067	<!> WARNING: Cancer and Reproductive Harm - www.P65warnings.ca.gov	CARBON BLACK
128068	<!> WARNING: Cancer and Reproductive Harm - www.P65warnings.ca.gov	CARBON BLACK
128069	<!> WARNING: Cancer and Reproductive Harm - www.P65warnings.ca.gov	CARBON BLACK
128070	<!> WARNING: Cancer and Reproductive Harm - www.P65warnings.ca.gov	CARBON BLACK
128071	<!> WARNING: Cancer and Reproductive Harm - www.P65warnings.ca.gov	CARBON BLACK
128072	<!> WARNING: Cancer and Reproductive Harm - www.P65warnings.ca.gov	CARBON BLACK
128073	<!> WARNING: Cancer and Reproductive Harm - www.P65warnings.ca.gov	CARBON BLACK
128074	<!> WARNING: Cancer and Reproductive Harm - www.P65warnings.ca.gov	CARBON BLACK
128075	<!> WARNING: Cancer and Reproductive Harm - www.P65warnings.ca.gov	CARBON BLACK
128076	<!> WARNING: Cancer and Reproductive Harm - www.P65warnings.ca.gov	CARBON BLACK
128077	<!> WARNING: Cancer and Reproductive Harm - www.P65warnings.ca.gov	CARBON BLACK
128078	<!> WARNING: Cancer and Reproductive Harm - www.P65warnings.ca.gov	CARBON BLACK
128079	<!> WARNING: Cancer and Reproductive Harm - www.P65warnings.ca.gov	CARBON BLACK
128252	<!> WARNING: Cancer and Reproductive Harm - www.P65warnings.ca.gov	
128253	<!> WARNING: Cancer and Reproductive Harm - www.P65warnings.ca.gov	LEAD AND LEAD COMPOUNDS
128256	<!> WARNING: Cancer and Reproductive Harm - www.P65warnings.ca.gov	LEAD AND LEAD COMPOUNDS

SECTION 5 • PAGE 115



▲ For **Proposition 65** warnings please refer to pages 93-124 at the end of this section.

All Products Used for Potable Water are:



Proposition 65 Warnings

Below is a listing of all items that come with a Proposition 65 Warning. All eligible items are in numerical order.

SECTION 5 • PAGE 116

STOCK#	WARNING	CHEMICAL	
128258	<I> WARNING: Cancer and Reproductive Harm - www.P65warnings.ca.gov	LEAD AND LEAD COMPOUNDS	
128259	<I> WARNING: Cancer and Reproductive Harm - www.P65warnings.ca.gov	CARBON BLACK; CHROMIUM (HEXAVALENT COMPOUNDS); LEAD AND LEAD COMPOUNDS	
128616	<I> WARNING: Cancer and Reproductive Harm - www.P65warnings.ca.gov	LEAD AND LEAD COMPOUNDS; NICKEL (METALLIC)	
129628	<I> WARNING: Cancer and Reproductive Harm - www.P65warnings.ca.gov	LEAD AND LEAD COMPOUNDS; NICKEL (METALLIC)	
129678	<I> WARNING: Cancer and Reproductive Harm - www.P65warnings.ca.gov	1 3-BUTADIENE; STYRENE	
130120	<I> WARNING: Reproductive Harm - www.P65warnings.ca.gov	BUTYL BENZYL PHTHALATE	
130418	<I> WARNING: Cancer and Reproductive Harm - www.P65warnings.ca.gov	LEAD; CARBON BLACK	
130420	<I> WARNING: Cancer and Reproductive Harm - www.P65warnings.ca.gov	LEAD	
130468	<I> WARNING: Cancer and Reproductive Harm - www.P65warnings.ca.gov	LEAD; CARBON BLACK	
130470	<I> WARNING: Cancer and Reproductive Harm - www.P65warnings.ca.gov	LEAD	
131100	<I> WARNING: Cancer and Reproductive Harm - www.P65warnings.ca.gov	LEAD AND LEAD COMPOUNDS	
131102	<I> WARNING: Cancer and Reproductive Harm - www.P65warnings.ca.gov	LEAD	
STOCK#	WARNING	CHEMICAL	CAS1
131108	<I> WARNING: Cancer and Reproductive Harm - www.P65warnings.ca.gov	LEAD	7439-92-1
STOCK#	WARNING	CHEMICAL	
131112	<I> WARNING: Reproductive Harm - www.P65warnings.ca.gov	BUTYL BENZYL PHTHALATE	
131115	<I> WARNING: Cancer and Reproductive Harm - www.P65warnings.ca.gov	LEAD AND LEAD COMPOUNDS	
131138	<I> WARNING: Cancer and Reproductive Harm - www.P65warnings.ca.gov	LEAD	
131146	<I> WARNING: Cancer and Reproductive Harm - www.P65warnings.ca.gov	LEAD	
131151	<I> WARNING: Cancer and Reproductive Harm - www.P65warnings.ca.gov		
131152	<I> WARNING: Cancer and Reproductive Harm - www.P65warnings.ca.gov		
STOCK#	WARNING	CHEMICAL	CAS1
131154	<I> WARNING: Cancer and Reproductive Harm - www.P65warnings.ca.gov	LEAD	7439-92-1
131196	<I> WARNING: Cancer and Reproductive Harm - www.P65warnings.ca.gov	LEAD	
131197	<I> WARNING: Cancer and Reproductive Harm - www.P65warnings.ca.gov	LEAD	7439-92-1



▲ For **Proposition 65** warnings please refer to pages 93-124 at the end of this section.

All Products Used for Potable Water are:



Proposition 65 Warnings

Below is a listing of all items that come with a Proposition 65 Warning. All eligible items are in numerical order.

STOCK#	WARNING	CHEMICAL	
131199	<!> WARNING: Cancer - www.P65warnings.ca.gov		
131252	<!> WARNING: Cancer and Reproductive Harm - www.P65warnings.ca.gov		
STOCK#	WARNING	CHEMICAL	CAS1
131254	<!> WARNING: Cancer and Reproductive Harm - www.P65warnings.ca.gov	LEAD	7439-92-1
STOCK#	WARNING	CHEMICAL	
131305	<!> WARNING: Cancer and Reproductive Harm - www.P65warnings.ca.gov		
131355	<!> WARNING: Cancer and Reproductive Harm - www.P65warnings.ca.gov		
131422	<!> WARNING: Cancer and Reproductive Harm - www.P65warnings.ca.gov		
131423	<!> WARNING: Cancer and Reproductive Harm - www.P65warnings.ca.gov		
131427	<!> WARNING: Cancer and Reproductive Harm - www.P65warnings.ca.gov		
131501	<!> WARNING: Cancer and Reproductive Harm - www.P65warnings.ca.gov	LEAD; NICKEL (METALLIC)	
131560	<!> WARNING: Cancer and Reproductive Harm - www.P65warnings.ca.gov	LEAD	
131561	<!> WARNING: Cancer and Reproductive Harm - www.P65warnings.ca.gov	LEAD	
131562	<!> WARNING: Cancer and Reproductive Harm - www.P65warnings.ca.gov	LEAD	
131564	<!> WARNING: Cancer and Reproductive Harm - www.P65warnings.ca.gov	LEAD	
131565	<!> WARNING: Cancer and Reproductive Harm - www.P65warnings.ca.gov	LEAD	
131566	<!> WARNING: Cancer and Reproductive Harm - www.P65warnings.ca.gov	LEAD	
131569	<!> WARNING: Cancer and Reproductive Harm - www.P65warnings.ca.gov	LEAD	
131577	<!> WARNING: Cancer and Reproductive Harm - www.P65warnings.ca.gov	LEAD	
131578	<!> WARNING: Cancer and Reproductive Harm - www.P65warnings.ca.gov	LEAD	
131581	<!> WARNING: Cancer and Reproductive Harm - www.P65warnings.ca.gov	LEAD	
131582	<!> WARNING: Cancer and Reproductive Harm - www.P65warnings.ca.gov	LEAD	
131583	<!> WARNING: Cancer and Reproductive Harm - www.P65warnings.ca.gov	LEAD	
131585	<!> WARNING: Cancer and Reproductive Harm - www.P65warnings.ca.gov	LEAD	
131588	<!> WARNING: Cancer and Reproductive Harm - www.P65warnings.ca.gov	LEAD	
131589	<!> WARNING: Cancer and Reproductive Harm - www.P65warnings.ca.gov	LEAD	
131592	<!> WARNING: Cancer and Reproductive Harm - www.P65warnings.ca.gov	LEAD	
131593	<!> WARNING: Cancer and Reproductive Harm - www.P65warnings.ca.gov	LEAD	
131594	<!> WARNING: Cancer and Reproductive Harm - www.P65warnings.ca.gov	LEAD	
131704	<!> WARNING: Cancer and Reproductive Harm - www.P65warnings.ca.gov		
131741	<!> WARNING: Cancer and Reproductive Harm - www.P65warnings.ca.gov	LEAD	

SECTION 5 • PAGE 117



▲ For **Proposition 65** warnings please refer to pages 93-124 at the end of this section.

All Products Used for Potable Water are:



Proposition 65 Warnings

Below is a listing of all items that come with a Proposition 65 Warning. All eligible items are In numerical order.

SECTION 5 • PAGE 118

STOCK#	WARNING	CHEMICAL	CAS1	
131745	<I> WARNING: Cancer and Reproductive Harm www.p65warnings.ca.gov			
131749	<I> WARNING: Cancer and Reproductive Harm - www.P65warnings.ca.gov	LEAD	7439-92-1	
131820	<I> WARNING: Cancer and Reproductive Harm - www.P65warnings.ca.gov	LEAD	7439-92-1	
131822	<I> WARNING: Cancer and Reproductive Harm - www.P65warnings.ca.gov	LEAD	7439-92-1	
132206	<I> WARNING: Cancer and Reproductive Harm - www.P65warnings.ca.gov	CHROMIUM (HEXAVALENT COMPOUNDS); LEAD; NICKEL (METALLIC)		
132212	<I> WARNING: Cancer and Reproductive Harm - www.P65warnings.ca.gov	DI (2-ETHYLHEXYL) PHTHALATE	117-81-7	
STOCK#	WARNING	CHEMICAL	CAS1	CAS2
132213	<I> WARNING: Cancer and Reproductive Harm - www.P65warnings.ca.gov	CHROMIUM (HEXAVALENT COMPOUNDS); LEAD; NICKEL (METALLIC)	18540-29-9	7440-02-0
STOCK#	WARNING	CHEMICAL		
132245	<I> WARNING: Cancer and Reproductive Harm - www.P65warnings.ca.gov			
132251	<I> WARNING: Cancer and Reproductive Harm - www.P65warnings.ca.gov	LEAD		
132253	<I> WARNING: Cancer and Reproductive Harm - www.P65warnings.ca.gov			
132256	<I> WARNING: Cancer and Reproductive Harm - www.P65Warnings.ca.gov	LEAD; NICKEL (METALLIC)		
132306	<I> WARNING: cancer and reproductive harm www.p65warnings.ca.gov			
132307	<I> WARNING: Cancer and Reproductive Harm www.p65warnings.ca.gov			
132314	<I> WARNING: Cancer - www.P65warnings.ca.gov	STYRENE		
132320	<I> WARNING: Cancer and Reproductive Harm www.p65warnings.ca.gov			
132321	<I> WARNING: Cancer and Reproductive Harm www.p65warnings.ca.gov			
132333	<I> WARNING: Cancer and Reproductive Harm - www.P65warnings.ca.gov	STYRENE; LEAD		
132343	<I> WARNING: Cancer and Reproductive Harm - www.P65warnings.ca.gov			
132351	<I> WARNING: Cancer and Reproductive Harm - www.P65warnings.ca.gov	LEAD		
132355	<I> WARNING: Cancer and Reproductive Harm - www.P65warnings.ca.gov	LEAD		
STOCK#	WARNING	CHEMICAL	CAS1	
132406	<I> WARNING: Cancer and Reproductive Harm - www.P65warnings.ca.gov	LEAD	7439-92-1	
132408	<I> WARNING: Cancer and Reproductive Harm - www.P65warnings.ca.gov	LEAD	7439-92-1	
132410	<I> WARNING: Cancer and Reproductive Harm - www.P65warnings.ca.gov	LEAD	7439-92-1	
132411	<I> WARNING: Cancer and Reproductive Harm - www.P65warnings.ca.gov	LEAD	7439-92-1	
132412	<I> WARNING: Cancer and Reproductive Harm - www.P65warnings.ca.gov	LEAD	7439-92-1	



▲ For **Proposition 65** warnings please refer to pages 93-124 at the end of this section.

All Products Used for Potable Water are:



Proposition 65 Warnings

Below is a listing of all items that come with a Proposition 65 Warning. All eligible items are in numerical order.

STOCK#	WARNING	CHEMICAL	
132418	<!> WARNING: Cancer and Reproductive Harm - www.P65warnings.ca.gov	CARBON BLACK; LEAD AND LEAD COMPOUNDS	
132419	<!> WARNING: Cancer and Reproductive Harm - www.P65warnings.ca.gov	LEAD	
132420	<!> WARNING: Cancer and Reproductive Harm - www.P65warnings.ca.gov	LEAD	
132426	<!> WARNING: Cancer and Reproductive Harm - www.P65warnings.ca.gov	LEAD; STYRENE	
132433	<!> WARNING: Cancer and Reproductive Harm - www.P65warnings.ca.gov	CARBON BLACK; LEAD	
STOCK#	WARNING	CHEMICAL	CAS1
132440	<!> WARNING: Cancer and Reproductive Harm - www.P65warnings.ca.gov	LEAD	7439-92-1
132441	<!> WARNING: Cancer and Reproductive Harm - www.P65warnings.ca.gov	LEAD	7439-92-1
132443	<!> WARNING: Cancer and Reproductive Harm - www.P65warnings.ca.gov	LEAD	7439-92-1
132444	<!> WARNING: Cancer and Reproductive Harm - www.P65warnings.ca.gov	LEAD	7439-92-1
132445	<!> WARNING: Cancer and Reproductive Harm - www.P65warnings.ca.gov	LEAD	7439-92-1
132446	<!> WARNING: Cancer and Reproductive Harm - www.P65warnings.ca.gov	LEAD	7439-92-1
STOCK#	WARNING	CHEMICAL	
132459	<!> WARNING: Cancer and Reproductive Harm - www.P65warnings.ca.gov		
132910	<!> WARNING: Cancer and Reproductive Harm - www.P65warnings.ca.gov		
132912	<!> WARNING: Cancer and Reproductive Harm - www.P65warnings.ca.gov		
140330	<!> WARNING: Cancer and Reproductive Harm - www.P65warnings.ca.gov		
140347	<!> WARNING: Cancer and Reproductive Harm - www.P65warnings.ca.gov		
141191	<!> WARNING: Cancer and Reproductive Harm - www.P65warnings.ca.gov	CARBON BLACK; LEAD	
141192	<!> WARNING: Cancer and Reproductive Harm - www.P65warnings.ca.gov	LEAD; STYRENE	
141197	<!> WARNING: Cancer and Reproductive Harm - www.P65warnings.ca.gov	CHROMIUM (HEXAVALENT COMPOUNDS); LEAD AND LEAD COMPOUNDS	
141198	<!> WARNING: Cancer and Reproductive Harm - www.P65warnings.ca.gov	CHROMIUM (HEXAVALENT COMPOUNDS); LEAD AND LEAD COMPOUNDS	
141199	<!> WARNING: Cancer and Reproductive Harm - www.P65warnings.ca.gov	LEAD; STYRENE	
141541	<!> WARNING: Cancer and Reproductive Harm - www.P65warnings.ca.gov	CARBON BLACK; LEAD AND LEAD COMPOUNDS	
141554	<!> WARNING: Cancer and Reproductive Harm - www.P65warnings.ca.gov	CHROMIUM (HEXAVALENT COMPOUNDS); LEAD AND LEAD COMPOUNDS	
141555	<!> WARNING: Cancer - www.P65warnings.ca.gov	STYRENE	

SECTION 5 • PAGE 119



▲ For **Proposition 65** warnings please refer to pages 93-124 at the end of this section.

All Products Used for Potable Water are:



Proposition 65 Warnings

Below is a listing of all items that come with a Proposition 65 Warning. All eligible items are In numerical order.

SECTION 5 • PAGE 120

STOCK#	WARNING	CHEMICAL		
141560	<I> WARNING: Cancer and Reproductive Harm - www.P65warnings.ca.gov	LEAD; STYRENE		
141561	<I> WARNING: Cancer and Reproductive Harm - www.P65warnings.ca.gov	LEAD; STYRENE		
141562	<I> WARNING: Cancer and Reproductive Harm - www.P65warnings.ca.gov	1 3-BUTADIENE; ACRYLAMIDE; CHROMIUM (HEXAVALENT COMPOUNDS); ETHYL ACRYLATE; LEAD; STYRENE		
141563	<I> WARNING: Cancer and Reproductive Harm - www.P65warnings.ca.gov	1 3-BUTADIENE; ACRYLAMIDE; CHROMIUM (HEXAVALENT COMPOUNDS); ETHYL ACRYLATE; LEAD; STYRENE		
141566	<I> WARNING: Cancer and Reproductive Harm - www.P65warnings.ca.gov			
141579	<I> WARNING: Cancer and Reproductive Harm - www.P65warnings.ca.gov			
141591	<I> WARNING: Cancer - www.P65warnings.ca.gov			
141596	<I> WARNING: Cancer and Reproductive Harm - www.P65warnings.ca.gov			
141597	<I> WARNING: Cancer and Reproductive Harm - www.P65warnings.ca.gov			
STOCK#	WARNING	CHEMICAL	CAS1	CAS2
680720	<I> WARNING: Cancer and Reproductive Harm - www.P65warnings.ca.gov	LEAD; NICKEL (METALLIC); DEHP	7439-92-1	117-81-7
680721	<I> WARNING: Cancer and Reproductive Harm - www.P65warnings.ca.gov	LEAD; NICKEL (METALLIC); DEHP	7439-92-1	117-81-7
680723	<I> WARNING: Cancer and Reproductive Harm - www.P65warnings.ca.gov	LEAD; NICKEL (METALLIC); DEHP	7439-92-1	117-81-7
680725	<I> WARNING: Cancer and Reproductive Harm - www.P65warnings.ca.gov	LEAD; NICKEL (METALLIC); DEHP	7439-92-1	117-81-7
680726	<I> WARNING: Cancer and Reproductive Harm - www.P65warnings.ca.gov	LEAD; NICKEL (METALLIC); DEHP	7439-92-1	117-81-7
680727	<I> WARNING: Cancer and Reproductive Harm - www.P65warnings.ca.gov	LEAD; NICKEL (METALLIC); DEHP	7439-92-1	117-81-7
680728	<I> WARNING: Cancer and Reproductive Harm - www.P65warnings.ca.gov	LEAD; NICKEL (METALLIC); DEHP	7439-92-1	117-81-7
680729	<I> WARNING: Cancer and Reproductive Harm - www.P65warnings.ca.gov	LEAD; NICKEL (METALLIC); DEHP	7439-92-1	117-81-7
680730	<I> WARNING: Cancer and Reproductive Harm - www.P65warnings.ca.gov	LEAD; NICKEL (METALLIC); DEHP	7439-92-1	117-81-7
680736	<I> WARNING: Cancer and Reproductive Harm - www.P65warnings.ca.gov	LEAD; NICKEL (METALLIC); DEHP	7439-92-1	117-81-7



▲ For **Proposition 65** warnings please refer to pages 93-124 at the end of this section.

All Products Used for Potable Water are:



Proposition 65 Warnings

Below is a listing of all items that come with a Proposition 65 Warning. All eligible items are in numerical order.

STOCK#	WARNING	CHEMICAL	CAS1	CAS2
680745	<I> WARNING: Cancer and Reproductive Harm - www.P65warnings.ca.gov	LEAD; CHROMIUM (HEXAVALENT COMPOUNDS); DI(2-ETHYLHEXYL) PHTHALATE (DEHP)	7439-92-1	117-81-7
680760	<I> WARNING: Cancer and Reproductive Harm - www.P65warnings.ca.gov	LEAD; CHROMIUM (HEXAVALENT COMPOUNDS); DI(2-ETHYLHEXYL) PHTHALATE (DEHP)	7439-92-1	117-81-7
680761	<I> WARNING: Cancer and Reproductive Harm - www.P65warnings.ca.gov	LEAD; CHROMIUM (HEXAVALENT COMPOUNDS); DI(2-ETHYLHEXYL) PHTHALATE (DEHP)	7439-92-1	117-81-7
STOCK#	WARNING	CHEMICAL		
680780	<I> WARNING: Cancer and Reproductive Harm - www.P65warnings.ca.gov	LEAD; CHROMIUM (HEXAVALENT COMPOUNDS); DI (2-ETHYLHEXYL) ETHYLHEXYL) PHTHALATE (DEHP)		
680781	<I> WARNING: Cancer and Reproductive Harm - www.P65warnings.ca.gov	LEAD; CHROMIUM (HEXAVALENT COMPOUNDS); DI (2-ETHYLHEXYL) ETHYLHEXYL) PHTHALATE (DEHP)		
680782	<I> WARNING: Cancer and Reproductive Harm - www.P65warnings.ca.gov	LEAD; CHROMIUM (HEXAVALENT COMPOUNDS); DI (2-ETHYLHEXYL) ETHYLHEXYL) PHTHALATE (DEHP)		
680783	<I> WARNING: Cancer and Reproductive Harm - www.P65warnings.ca.gov	LEAD; CHROMIUM (HEXAVALENT COMPOUNDS); DI (2-ETHYLHEXYL) ETHYLHEXYL) PHTHALATE (DEHP)		
680784	<I> WARNING: Cancer and Reproductive Harm - www.P65warnings.ca.gov	LEAD; CHROMIUM (HEXAVALENT COMPOUNDS); DI (2-ETHYLHEXYL) ETHYLHEXYL) PHTHALATE (DEHP)		
680785	<I> WARNING: Cancer and Reproductive Harm - www.P65warnings.ca.gov	LEAD; CHROMIUM (HEXAVALENT COMPOUNDS); DI (2-ETHYLHEXYL) ETHYLHEXYL) PHTHALATE (DEHP)		
680786	<I> WARNING: Cancer and Reproductive Harm - www.P65warnings.ca.gov	LEAD; CHROMIUM (HEXAVALENT COMPOUNDS); DI (2-ETHYLHEXYL) ETHYLHEXYL) PHTHALATE (DEHP)		

SECTION 5 • PAGE 121



▲ For **Proposition 65** warnings please refer to pages 93-124 at the end of this section.

All Products Used for Potable Water are:



Proposition 65 Warnings

Below is a listing of all items that come with a Proposition 65 Warning. All eligible items are in numerical order.

SECTION 5 • PAGE 122

STOCK#	WARNING	CHEMICAL		
680787	<I> WARNING: Cancer and Reproductive Harm - www.P65warnings.ca.gov	LEAD; CHROMIUM (HEXAVALENT COMPOUNDS); DI (2-ETHYLHEXYL) ETHYLHEXYL PHTHALATE (DEHP)		
680788	<I> WARNING: Cancer and Reproductive Harm - www.P65warnings.ca.gov	LEAD; CHROMIUM (HEXAVALENT COMPOUNDS); DI (2-ETHYLHEXYL) ETHYLHEXYL PHTHALATE (DEHP)		
680789	<I> WARNING: Cancer and Reproductive Harm - www.P65warnings.ca.gov	LEAD; CHROMIUM (HEXAVALENT COMPOUNDS); DI (2-ETHYLHEXYL) ETHYLHEXYL PHTHALATE (DEHP)		
STOCK#	WARNING	CHEMICAL	CAS1	CAS2
680790	<I> WARNING: Cancer and Reproductive Harm - www.P65warnings.ca.gov	LEAD; CHROMIUM (HEXAVALENT COMPOUNDS); DI (2-ETHYLHEXYL) ETHYLHEXYL PHTHALATE (DEHP)	7439-92-1	117-81-7
680791	<I> WARNING: Cancer and Reproductive Harm - www.P65warnings.ca.gov	LEAD; CHROMIUM (HEXAVALENT COMPOUNDS); DI (2-ETHYLHEXYL) ETHYLHEXYL PHTHALATE (DEHP)	7439-92-1	117-81-7
680792	<I> WARNING: Cancer and Reproductive Harm - www.P65warnings.ca.gov	LEAD; CHROMIUM (HEXAVALENT COMPOUNDS); DI (2-ETHYLHEXYL) ETHYLHEXYL PHTHALATE (DEHP)		
680793	<I> WARNING: Cancer and Reproductive Harm - www.P65warnings.ca.gov	LEAD; CHROMIUM (HEXAVALENT COMPOUNDS); DI (2-ETHYLHEXYL) ETHYLHEXYL PHTHALATE (DEHP)	7439-92-1	117-81-7
680794	<I> WARNING: Cancer and Reproductive Harm - www.P65warnings.ca.gov	LEAD; CHROMIUM (HEXAVALENT COMPOUNDS); DI (2-ETHYLHEXYL) ETHYLHEXYL PHTHALATE (DEHP)		
680795	<I> WARNING: Cancer and Reproductive Harm - www.P65warnings.ca.gov	LEAD; CHROMIUM (HEXAVALENT COMPOUNDS); DI (2-ETHYLHEXYL) ETHYLHEXYL PHTHALATE (DEHP)		
680796	<I> WARNING: Cancer and Reproductive Harm - www.P65warnings.ca.gov	LEAD; CHROMIUM (HEXAVALENT COMPOUNDS); DI (2-ETHYLHEXYL) ETHYLHEXYL PHTHALATE (DEHP)		



▲ For **Proposition 65** warnings please refer to pages 93-124 at the end of this section.

All Products Used for Potable Water are:



Proposition 65 Warnings

Below is a listing of all items that come with a Proposition 65 Warning. All eligible items are in numerical order.

STOCK#	WARNING	CHEMICAL	CAS1	CAS2
680797	<I> WARNING: Cancer and Reproductive Harm - www.P65warnings.ca.gov	LEAD; CHROMIUM (HEXAVALENT COMPOUNDS); DI (2-ETHYLHEXYL) ETHYLHEXYL) PHTHALATE (DEHP)	7439-92-1	117-81-7
680803	<I> WARNING: Cancer and Reproductive Harm - www.P65warnings.ca.gov	LEAD; CHROMIUM (HEXAVALENT COMPOUNDS); DI (2-ETHYLHEXYL) ETHYLHEXYL) PHTHALATE (DEHP)	7439-92-1	117-81-7
680804	<I> WARNING: Cancer and Reproductive Harm - www.P65warnings.ca.gov	LEAD; CHROMIUM (HEXAVALENT COMPOUNDS); DI (2-ETHYLHEXYL) ETHYLHEXYL) PHTHALATE (DEHP)	7439-92-1	117-81-7
680805	<I> WARNING: Cancer and Reproductive Harm - www.P65warnings.ca.gov	LEAD; CHROMIUM (HEXAVALENT COMPOUNDS); DI (2-ETHYLHEXYL) ETHYLHEXYL) PHTHALATE (DEHP)	7439-92-1	117-81-7
680806	<I> WARNING: Cancer and Reproductive Harm - www.P65warnings.ca.gov	LEAD; CHROMIUM (HEXAVALENT COMPOUNDS); DI (2-ETHYLHEXYL) ETHYLHEXYL) PHTHALATE (DEHP)	7439-92-1	117-81-7
680807	<I> WARNING: Cancer and Reproductive Harm - www.P65warnings.ca.gov	LEAD; CHROMIUM (HEXAVALENT COMPOUNDS); DI (2-ETHYLHEXYL) ETHYLHEXYL) PHTHALATE (DEHP)	7439-92-1	117-81-7
680808	<I> WARNING: Cancer and Reproductive Harm - www.P65warnings.ca.gov	LEAD; CHROMIUM (HEXAVALENT COMPOUNDS); DI (2-ETHYLHEXYL) ETHYLHEXYL) PHTHALATE (DEHP)	7439-92-1	117-81-7
680809	<I> WARNING: Cancer and Reproductive Harm - www.P65warnings.ca.gov	LEAD; CHROMIUM (HEXAVALENT COMPOUNDS); DI (2-ETHYLHEXYL) ETHYLHEXYL) PHTHALATE (DEHP)	7439-92-1	117-81-7
680810	<I> WARNING: Cancer and Reproductive Harm - www.P65warnings.ca.gov	LEAD; CHROMIUM (HEXAVALENT COMPOUNDS); DI (2-ETHYLHEXYL) ETHYLHEXYL) PHTHALATE (DEHP)	7439-92-1	117-81-7
680811	<I> WARNING: Cancer and Reproductive Harm - www.P65warnings.ca.gov	LEAD; CHROMIUM (HEXAVALENT COMPOUNDS); DI (2-ETHYLHEXYL) ETHYLHEXYL) PHTHALATE (DEHP)	7439-92-1	117-81-7

SECTION 5 • PAGE 123



▲ For **Proposition 65** warnings please refer to pages 93-124 at the end of this section.

All Products Used for Potable Water are:



Proposition 65 Warnings

Below is a listing of all items that come with a Proposition 65 Warning. All eligible items are in numerical order.

SECTION 5 • PAGE 124

STOCK#	WARNING	CHEMICAL	CAS1	CAS2
680812	<I> WARNING: Cancer and Reproductive Harm - www.P65warnings.ca.gov	LEAD; CHROMIUM (HEXAVALENT COMPOUNDS); DI (2-ETHYLHEXYL) ETHYLHEXYL) PHTHALATE (DEHP)	7439-92-1	117-81-7
680819	<I> WARNING: Cancer and Reproductive Harm - www.P65warnings.ca.gov	LEAD; CHROMIUM (HEXAVALENT COMPOUNDS); DI (2-ETHYLHEXYL) ETHYLHEXYL) PHTHALATE (DEHP)	7439-92-1	117-81-7
680822	<I> WARNING: Cancer and Reproductive Harm - www.P65warnings.ca.gov	LEAD; NICKEL (METALLIC); DEHP	7439-92-1	117-81-7
680824	<I> WARNING: Cancer and Reproductive Harm - www.P65warnings.ca.gov	LEAD; NICKEL (METALLIC); DEHP	7439-92-1	117-81-7
680831	<I> WARNING: Cancer and Reproductive Harm - www.P65warnings.ca.gov	LEAD; NICKEL (METALLIC); DEHP	7439-92-1	117-81-7
680832	<I> WARNING: Cancer and Reproductive Harm - www.P65warnings.ca.gov	LEAD; NICKEL (METALLIC); DEHP	7439-92-1	117-81-7
680833	<I> WARNING: Cancer and Reproductive Harm - www.P65warnings.ca.gov	LEAD; NICKEL (METALLIC)	7439-92-1	117-81-7
680835	<I> WARNING: Cancer and Reproductive Harm - www.P65warnings.ca.gov	LEAD; NICKEL (METALLIC); DEHP	7439-92-1	117-81-7
STOCK#	WARNING	CHEMICAL	CAS1	
680840	<I> WARNING: Cancer and Reproductive Harm - www.P65warnings.ca.gov	LEAD; CHROMIUM (HEXAVALENT COMPOUNDS); DI(2-ETHYLHEXYL) PHTHALATE (DEHP)	7439-92-1	
680841	<I> WARNING: Cancer and Reproductive Harm - www.P65warnings.ca.gov	LEAD; CHROMIUM (HEXAVALENT COMPOUNDS); DI(2-ETHYLHEXYL) PHTHALATE (DEHP)	7439-92-1	
680842	<I> WARNING: Cancer and Reproductive Harm - www.P65warnings.ca.gov	LEAD; CHROMIUM (HEXAVALENT COMPOUNDS); DI(2-ETHYLHEXYL) PHTHALATE (DEHP)	7439-92-1	



▲ For **Proposition 65** warnings please refer to pages 93-124 at the end of this section.

All Products Used for Potable Water are:

