

SharkBite  
Plumbing  
System

Product  
Catalog



# SharkBite®

Plumbing System





For more than two decades, SharkBite has been at the forefront of innovating solutions that help the plumbing trade work more productively and efficiently. As the leader of push-to-connect plumbing, we create solutions that works across a wide range of applications, including service and repair, remodel, repiping and new construction.

# Table of contents

Welcome to our complete range of products and solutions.

## Push-to-Connect Fittings

Rough Plumbing Fittings	11
Radiant Fittings	17
PVC & Polybutylene Transition Fittings	18
Flexible Water Heater & Softener Connectors	19
Stops & Fixture Supply Fittings	20
Additional Products	23
Kits	25
Outlet Boxes & Washing Machine Valves	26
Tools and Accessories	27

## Valves

Ball Valves	32
Outdoor Hose Valves	33
Pressure Regulating Valves	35
Thermostatic Mixing Valves	36
Check Valves	36
Thermal Expansion Relief Valve	37
Temperature & Pressure Relief Valves	37

## EvoPEX Push-to-Connect Fittings

Rough Plumbing Fittings	40
Supply Stops	43
Ball Valves	43

## PEX Crimp & Clamp Fittings

Brass Rough Plumbing Fittings	46
Transition Fittings	50
Poly Rough Plumbing Fittings	50
Supply Stops	52
Stub-outs, Manifolds & Arrestors	53
Ball Valves	53
Outlet Boxes & Washing Machine Valves	54
Tools & Accessories	55

## PEX Pipe

Potable Water PEX Pipe	60
Reclaimed Water PEX Pipe	61
Oxygen Barrier PEX Pipe	61

## Warranty

63

## Index

66





# One complete solution

Reliance Worldwide Corporation® (RWC) is a market leader and manufacturer of water control systems and plumbing solutions for residential, commercial and industrial applications. Established in 1949, the RWC portfolio includes industry-leading brands: SharkBite® Push-to-Connect plumbing solutions; HoldRite® engineered plumbing and mechanical solutions; Cash Acme® control valves; John Guest® fittings and fluid dispense products and StreamLabs® smart water technologies. Engineered for quality and efficiency, the portfolio of products from the RWC brands work together to create an end-to-end solution from meter to fixture, floor to ceiling.



## Push-to-connect system

Push-to-connect plumbing solutions for residential and commercial applications.



## Engineered solutions

Secondary pipe supports, acoustic noise and vibration plumbing solutions, firestop systems, DWV testing solutions and water heater accessories.





### Water control valves

Pressure regulating valves, thermostatic mixing valves and temperature & pressure relief valves for safeguarding water systems.



### Smart home water monitor

Smart home water monitor and leak detection technology to protect homes from water damage.



### Specialist industry solutions

Push-to-connect solutions for specialist industries and OEMs.



# Uniting our family of brands

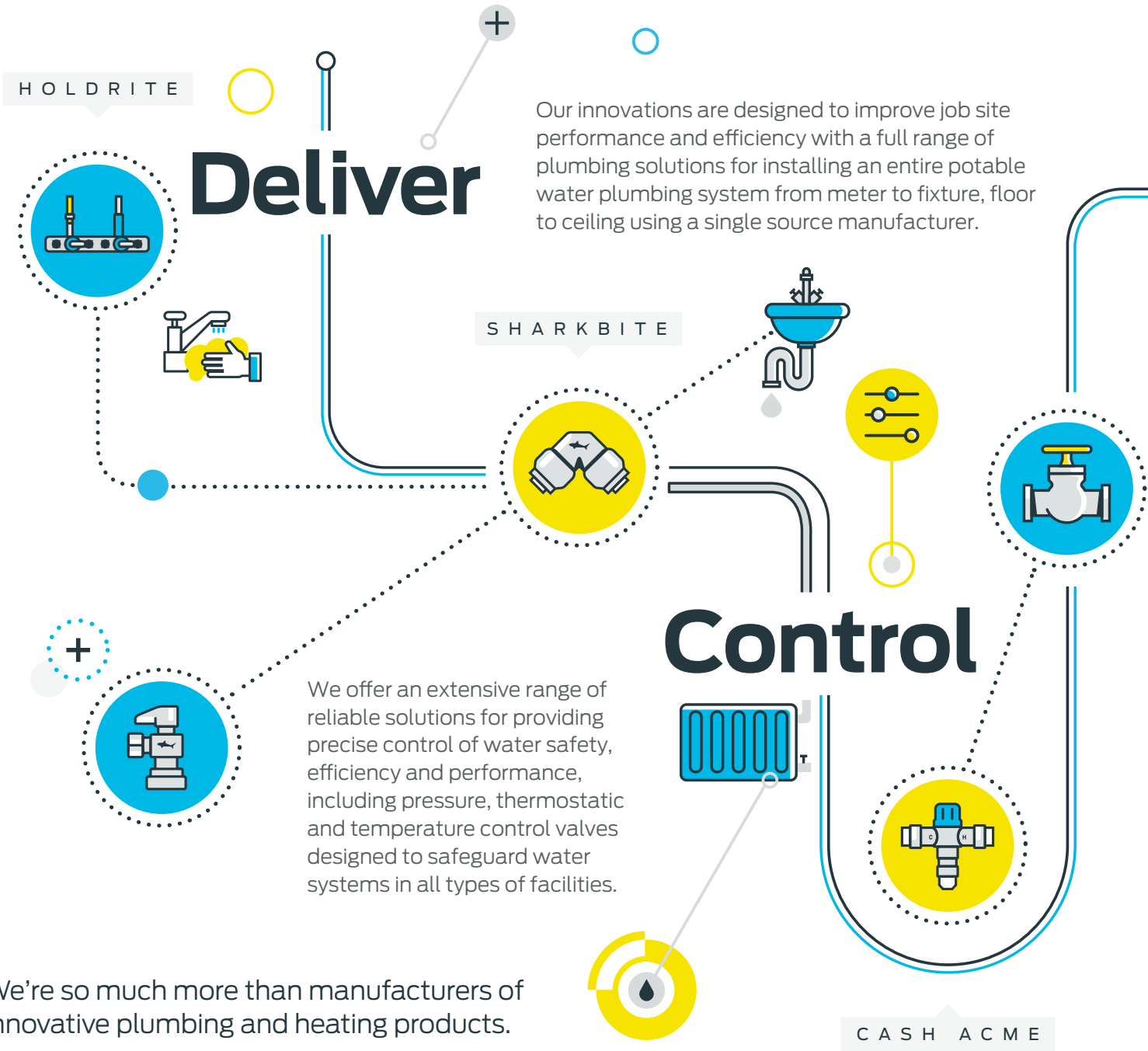

We're so much more than manufacturers of innovative plumbing and heating products.

We **'Deliver, Control, Optimize and Solve'** for a diverse range of customers around the world.

STREAMLABS



# Optimize

Our smart water technology enables the tracking of water consumption and provides real-time alerts on possible leaks, as well as giving visibility to water usage and habits, helping identify ways to conserve.

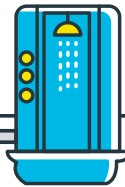

JOHN GUEST



# Solve

We provide intelligent pipe and connection solutions to move liquid and air for specialist industries across the world. Our technologies serve industries such as plumbing, drink dispense, pneumatics, compressed air and water purification.





# Redefining efficiency

For more than 20 years and with over 250 million fittings installed, SharkBite has been at the forefront of innovating solutions for helping the plumbing trade improve efficiency with enhanced jobsite performance. Being a leader through continuous innovation and providing solutions that address the challenges that plumbing professionals face every day is who we are.

Whether you are repairing a water line, installing a water heater, remodeling a home or plumbing a system in a new construction job, SharkBite provides proven solutions that save time, reduce cost and have the versatility to overcome the most difficult situations.







## The mark of quality

### **Speed and ease of use**

Push-to-connect design enables efficient install. No special tools, glue or solder required, which means more productivity and lower risk of installation errors.

### **Quality**

Field-tested with more than 1.5 million connections every week. SharkBite owns its manufacturing process and backs its products with a 25-year system warranty.

### **Versatility**

SharkBite brass push fittings are compatible with PEX, copper, CPVC, HDPE and PE-RT pipe. Solutions are also available for PVC and polybutylene pipe.

### **Code Approved**

Approved for underground and behind-the-wall applications with no access panels. Wrapping required when burying brass fittings underground.

# SharkBite

## plumbing system

How to install SharkBite push-to-connect products.

### Cut

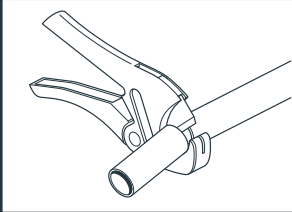

Cut the pipe square removing rough edges and debris. Mark the pipe to the correct insertion depth.

### Push

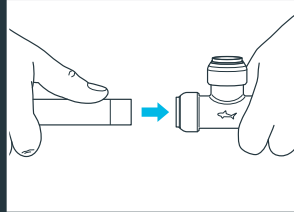

Push pipe and fitting together up to the depth mark.

### Done

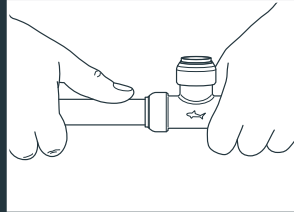

### Disconnect

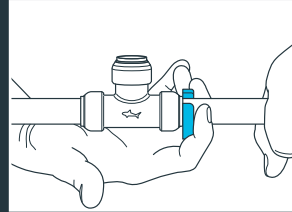

Using the disconnect clip, fittings can be easily changed, removed and reused.

### SharkBite Fittings / Pipe Size Compatibility / Pipe Insertion Depth

SharkBite Fitting Size (In.)	Nominal Pipe Size	Pipe OD Size (In.)	Pipe Insertion Depth Fraction (In.)	Pipe Insertion Depth (MM)
1/4	1/4 in. CTS	3/8	7/8	20.73
3/8	3/8 in. CTS	1/2	1	23.97
1/2	1/2 in. CTS	5/8	1	24.25
5/8	5/8 in. CTS	3/4	1-1/8	28.82
3/4	3/4 in. CTS	7/8	1-1/8	28.4
1	1 in. CTS	1-1/8	1-4/8	32.2
1-1/4	1-1/4 in. CTS	1-3/8	1-7/8	47.8
1-1/2	1-1/2 in. CTS	1-5/8	2	52
2	2 in. CTS	2-1/8	2-1/4	55.7

# Rough Plumbing Fittings

## Coupling



Part number	Description	Qty
U004LF	1/4 in. (3/8 in. OD) x 1/4 in. (3/8 in. OD)	6
U006LF	3/8 in. (1/2 in. OD) x 3/8 in. (1/2 in. OD)	6
U008LF	1/2 in. x 1/2 in.	12
U016LF	3/4 in. x 3/4 in.	12
U020LF	1 in. x 1 in.	6
UXL0135	1-1/4 in. x 1-1/4 in. *	1
UXL0141	1-1/2 in. x 1-1/2 in. *	1
UXL0154	2 in. x 2 in. *	1

\* For PEX applications, stiffeners are sold separately.

## Reducing Coupling



Part number	Description	Qty
U050LF	1/2 in. x 1/4 in. (3/8 in. OD)	6
U009LF	1/2 in. x 3/8 in. (1/2 in. OD)	6
U058LF	3/4 in. x 1/2 in.	12
U060LF	1 in. x 3/4 in.	6
UXL013528	1-1/4 in. x 1 in. *	1
UXL014128	1-1/2 in. x 1 in. *	1
UXL014135	1-1/2 in. x 1-1/4 in. *	1
UXL015441	2 in. x 1-1/2 in. *	1

\* For PEX applications, stiffeners are sold separately.

## Slip Coupling (only suitable for copper and CPVC)



Slip couplings are the most efficient way to repair a burst pipe or leak. Slip fittings simply repair by doing the job that two couplings and extra pipe used to do. Only one end of the coupling has a stop, allowing the opposite end to slide freely over the end of a pipe. The fittings can then be released with a disconnect tool and slid back onto the other end of the pipe for a successful connection and leak repair.

Part number	Description	Qty
U3016LF	3/4 in. x 3/4 in.	3
U3008LF	1/2 in. x 1/2 in.	3
U3020LF	1 in. x 1 in.	1
UXL0635	1-1/4 in. x 1-1/4 in. *	1
UXL0641	1-1/2 in. x 1-1/2 in. *	1
UXL0654	2 in. x 2 in. *	1

\* For PEX applications, stiffeners are sold separately.

# Rough Plumbing Fittings

## Female Connector



Part number	Description	Qty
U066LF	1/4 in. (3/8 in. OD) x 1/2 in. FNPT	6
U070LF	3/8 in. (1/2 in. OD) x 1/2 in. FNPT	6
U072LF	1/2 in. x 1/2 in. FNPT	12
U068LF	1/2 in. x 3/4 in. FNPT	6
U092LF	3/4 in. x 1/2 in. FNPT Bullnose	6
U088LF	3/4 in. x 3/4 in. FNPT	6
U094LF	1 in. x 1 in. FNPT	6
UXL113532F	1-1/4 in. x 1-1/4 in. FNPT *	1
UXL114140F	1-1/2 in. x 1-1/2 in. FNPT *	1
UXL115450F	2 in. x 2 in. FNPT *	1

\* For PEX applications, stiffeners are sold separately.

## Male Connector



Part number	Description	Qty
U110LF	1/4 in. x 1/2 in. MNPT	6
U118LF	3/8 in. (1/2 in. OD) x 1/2 in. MNPT	6
U120LF	1/2 in. x 1/2 in. MNPT	12
U116LF	1/2 in. x 3/4 in. MNPT	6
U138LF	3/4 in. x 1/2 in. MNPT Bullnose	12
U134LF	3/4 in. x 3/4 in. MNPT	12
U139LF	3/4 in. x 1 in. MNPT	6
U142LF	1 in. x 3/4 in. MNPT	6
U140LF	1 in. x 1 in. MNPT	6
UXL113532M	1-1/4 in. x 1-1/4 in. MNPT *	1
UXL114140M	1-1/2 in. x 1-1/2 in. MNPT *	1
UXL115450M	2 in. x 2 in. MNPT *	1

\* For PEX applications, stiffeners are sold separately.

## Slip Male Connector



Part number	Description	Qty
U3120LF	1/2 in. x 1/2 in. MNPT	6
U3134LF	3/4 in. x 3/4 in. MNPT	6
U3140LF	1 in. x 1 in. MNPT	6

## Threaded Adapter



Part number	Description	Qty
U766LF	3/4 in. CTS x 3/4 in. FNPT (CTS end inserts into any 3/4 in. SB fitting)	6
U772LF	1 in. CTS x 1 in. FNPT (CTS end inserts into any 1 in. SB fitting)	6



## 90° Elbow



Part number	Description	Qty
U244LF	1/4 in. (3/8 in. OD) x 1/4 in. (3/8 in. OD)	6
U246LF	3/8 in. (1/2 in. OD) x 3/8 in. (1/2 in. OD)	6
U248LF	1/2 in. x 1/2 in.	12
U256LF	3/4 in. x 3/4 in.	6
U260LF	1 in. x 1 in.	6
UXL0235	1-1/4 in. x 1-1/4 in. *	1
UXL0241	1-1/2 in. x 1-1/2 in. *	1
UXL0254	2 in. x 2 in. *	1

\* For PEX applications, stiffeners are sold separately.

## 90° Elbow with Drain/Vent



Part number	Description	Qty
U5248LF	1/2 in. x 1/2 in. x 1/8 in. NPSM Drain Thread	6
U5256LF	3/4 in. x 3/4 in. x 1/8 in. NPSM Drain Thread	6
U5260LF	1 in. x 1 in. x 1/8 in. NPSM Drain Thread	3
24377	1/8 in. NPSM Replacement Drain Cap	1

## 90° Street Elbow



Part number	Description	Qty
UXL0935	1-1/4 in. x 1-1/4 in. *	1
UXL0941	1-1/2 in. x 1-1/2 in. *	1
UXL0954	2 in. x 2 in. *	1

\* For PEX applications, stiffeners are sold separately.

## 45° Elbow



Part number	Description	Qty
U648LF	1/2 in. x 1/2 in.	12
U656LF	3/4 in. x 3/4 in.	6
U660LF	1 in. x 1 in.	12
UXL0535	1-1/4 in. x 1-1/4 in. *	1
UXL0541	1-1/2 in. x 1-1/2 in. *	1
UXL0554	2 in. x 2 in. *	1

\* For PEX applications, stiffeners are sold separately.

## 45° Street Elbow



Part number	Description	Qty
U615LF	1/2 in. x 1/2 in. CTS Tail Adapter (CTS end inserts into any 1/2 in. SB fitting)	6
U620LF	3/4 in. x 3/4 in. CTS Tail Adapter (CTS end inserts into any 3/4 in. SB fitting)	6
UXL0735	1-1/4 in. x 1-1/4 in. *	1
UXL0741	1-1/2 in. x 1-1/2 in. *	1
UXL0754	2 in. x 2 in. *	1

\* For PEX applications, stiffeners are sold separately.

# Rough Plumbing Fittings

## Female Elbow



Part number	Description	Qty
U308LF	1/2 in. x 1/2 in. FNPT	6
U314LF	3/4 in. x 3/4 in. FNPT	3

## Male Elbow



Part number	Description	Qty
U280LF	1/2 in. x 1/2 in. MNPT	6
U286LF	3/4 in. x 3/4 in. MNPT	6

## Reducing Elbow



Part number	Description	Qty
U272LF	1/2 in. x 3/8 in. (1/2 in. OD)	12
U274LF	3/4 in. x 1/2 in.	6
U278LF	1 in. x 3/4 in.	3

## Drop-Ear Elbow



Part number	Description	Qty
U332LF	3/8 in. (1/2 in. OD) x 1/2 in. FNPT	6
U249LF	1/2 in. x 1/2 in.	12
U334LF	1/2 in. x 1/2 in. FNPT	6
U340LF	3/4 in. x 3/4 in. FNPT	6

## Hy-Ear Elbow



Part number	Description	Qty
U335LF	1/2 in. x 1/2 in. Hy-Ear	6

## Shower Test Plug



Part number	Description	Qty
25828	1/2 in. MNPT	1

## Dishwasher Elbow



Part number	Description	Qty
U276LF	1/4 in. (3/8 in. OD) x 3/8 in. MNPT	6
U2276LF	1/4 in. (3/8 in. OD) x 3/4 in. Garden Hose Nut	6
U281LF	1/2 in. x 3/8 in. MNPT	6

## Tee



Part number	Description	Qty
U358LF	1/4 in. (3/8 in. OD) x 1/4 in. (3/8 in. OD) x 1/4 in. (3/8 in. OD)	6
U360LF	3/8 in. (1/2 in. OD) x 3/8 in. (1/2 in. OD) x 3/8 in. (1/2 in. OD)	6
U362LF	1/2 in. x 1/2 in. x 1/2 in.	12
U370LF	3/4 in. x 3/4 in. x 3/4 in.	6
U374LF	1 in. x 1 in. x 1 in.	3
UXL0835	1-1/4 in. x 1-1/4 in. x 1-1/4 in.*	1
UXL0841	1-1/2 in. x 1-1/2 in. x 1-1/2 in.*	1
UXL0854	2 in. x 2 in. x 2 in.*	1

\*For PEX applications, stiffeners are sold separately.

## Reducing Tee

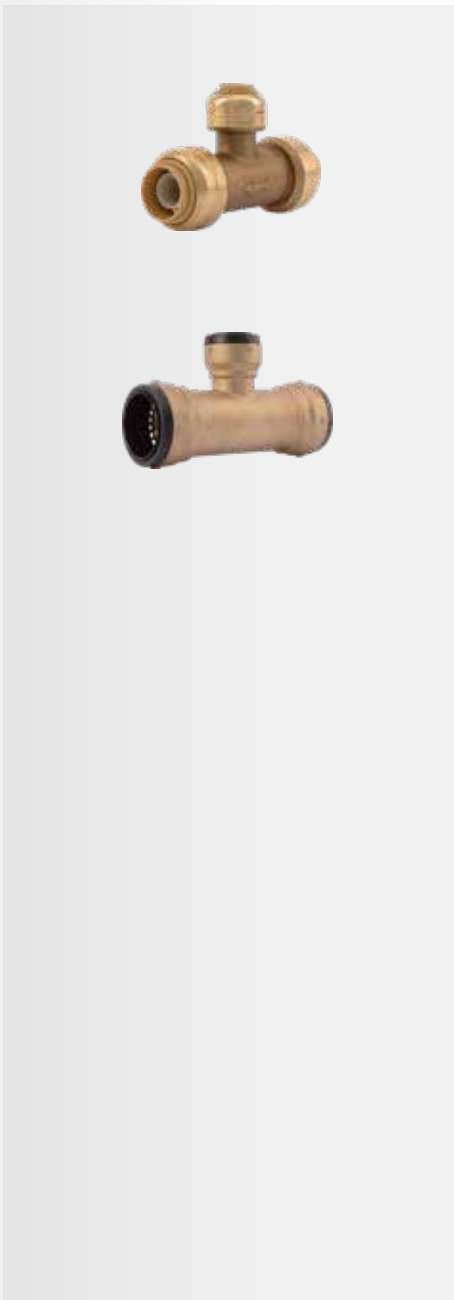

Part number	Description	Qty
U364LF	3/8 in. (1/2 in. OD) x 3/8 in. (1/2 in. OD) x 1/2 in.	6
U359LF	1/2 in. x 1/2 in. x 1/4 in. (3/8 in. OD)	6
U363LF	1/2 in. x 1/2 in. x 3/8 in. (1/2 in. OD)	6
U454LF	3/4 in. x 1/2 in. x 1/2 in.	6
U412LF	3/4 in. x 3/4 in. x 1/2 in.	6
U444LF	3/4 in. x 1/2 in. x 3/4 in.	6
U416LF	1 in. x 1 in. x 3/4 in.	3
UXL08351635	1-1/4 in. x 1/2 in. x 1-1/4 in. *	1
UXL08352216	1-1/4 in. x 3/4 in. x 1/2 in. *	1
UXL08352222	1-1/4 in. x 3/4 in. x 3/4 in. *	1
UXL08352228	1-1/4 in. x 3/4 in. x 1 in. *	1
UXL08352235	1-1/4 in. x 3/4 in. x 1-1/4 in. *	1
UXL08352816	1-1/4 in. x 1 in. x 1/2 in. *	1
UXL08352822	1-1/4 in. x 1 in. x 3/4 in. *	1
UXL08352828	1-1/4 in. x 1 in. x 1 in. *	1
UXL08353516	1-1/4 in. x 1-1/4 in. x 1/2 in. *	1
UXL08353522	1-1/4 in. x 1-1/4 in. x 3/4 in. *	1
UXL08353528	1-1/4 in. x 1-1/4 in. x 1 in. *	1
UXL08414122	1-1/2 in. x 1-1/2 in. x 3/4 in. *	1
UXL08412822	1-1/2 in. x 1 in. x 3/4 in. *	1
UXL08412828	1-1/2 in. x 1 in. x 1 in. *	1
UXL08412841	1-1/2 in. x 1 in. x 1-1/2 in. *	1
UXL08413522	1-1/2 in. x 1-1/4 in. x 3/4 in. *	1
UXL08413528	1-1/2 in. x 1-1/4 in. x 1 in. *	1
UXL08413535	1-1/2 in. x 1-1/4 in. x 1-1/4 in. *	1
UXL08414116	1-1/2 in. x 1-1/2 in. x 1/2 in. *	1
UXL08414128	1-1/2 in. x 1-1/2 in. x 1 in. *	1
UXL08414135	1-1/2 in. x 1-1/2 in. x 1-1/4 in. *	1
UXL08543535	2 in. x 1-1/4 in. x 1-1/4 in. *	1
UXL08544122	2 in. x 1-1/2 in. x 3/4 in. *	1
UXL08544128	2 in. x 1-1/2 in. x 1 in. *	1
UXL08544135	2 in. x 1-1/2 in. x 1-1/4 in. *	1
UXL08544141	2 in. x 1-1/2 in. x 1-1/2 in. *	1
UXL08544154	2 in. x 1-1/2 in. x 2 in. *	1
UXL08545416	2 in. x 2 in. x 1/2 in. *	1
UXL08545422	2 in. x 2 in. x 3/4 in. *	1
UXL08545428	2 in. x 2 in. x 1 in. *	1
UXL08545435	2 in. x 2 in. x 1-1/4 in. *	1
UXL08545441	2 in. x 2 in. x 1-1/2 in. *	1

\*For PEX applications, stiffeners are sold separately.

# Rough Plumbing Fittings

## Cross Tee



Part number	Description	Qty
U380LF	3/4 in. x 3/4 in. x 1/2 in. x 1/2 in.	3

## Female Center Tee



Part number	Description	Qty
U462LF	3/4 in. x 3/4 in. x 3/4 in. (Utilizes a U766LF thread adapter)	3
U464LF	1 in. x 1 in. x 1 in. (Utilizes a U772LF thread adapter)	3

## Female Center Slip Tee (slip end only suitable for copper and CPVC)



Part number	Description	Qty
U3482LF	1/2 in. x 1/2 in. x 1/2 in. FNPT	3
U3486LF	3/4 in. x 3/4 in. x 3/4 in. FNPT	3

## Slip Tee (slip end only suitable for copper and CPVC)



Part number	Description	Qty
U3362LF	1/2 in. x 1/2 in. x 1/2 in.	3
U3370LF	3/4 in. x 3/4 in. x 3/4 in.	3
UXL0335	1-1/4 in. x 1-1/4 in. *	1
UXL0341	1-1/2 in. x 1-1/2 in. *	1
UXL0354	2 in. x 2 in. *	1

\*For PEX applications, stiffeners are sold separately.

## Service Slip Tee Adapter (slip end only suitable for copper and CPVC)



Part number	Description	Qty
U4482LF	1/2 in. x 1/2 in. X 1/2 in. CTS Tail Adapter Service Line Tee (CTS end inserts into any 1/2 in. SB fitting)	6



## End Cap



Part number	Description	Qty
U512LF	3/8 in. (1/2 in. OD)	6
U514LF	1/2 in.	12
U518LF	3/4 in.	6
U520LF	1 in.	6
UXL0435	1-1/4 in. *	1
UXL0441	1-1/2 in. *	1
UXL0454	2 in. *	1

\*For PEX applications, stiffeners are sold separately.

## Fitting Reducer (use to connect to smaller pipe sizes)



Part number	Description *	Qty
U719LF	3/8 in. (1/2 in. OD) X 1/2 in. CTS (CTS end inserts into any 1/2 in. SB fitting)	6
U721LF	3/8 in. (1/2 in. OD) X 3/4 in. CTS (CTS end inserts into any 3/4 in. SB fitting)	6
U722LF	1/2 in. x 1 in. CTS (CTS end inserts into any 1 in. SB fitting)	6
U724LF	3/4 in. x 1 in. CTS (CTS end inserts into any 1 in. SB fitting)	6
UXL123516	1-1/4 in. x 1/2 in. *	1
UXL123522	1-1/4 in. x 3/4 in. *	1
UXL123528	1-1/4 in. x 1 in. *	1
UXL124116	1-1/2 in. x 1/2 in. *	1
UXL124122	1-1/2 in. x 3/4 in. *	1
UXL124128	1-1/2 in. x 1 in. *	1
UXL124135	1-1/2 in. x 1-1/4 in. *	1
UXL125416	2 in. x 1/2 in. *	1
UXL125422	2 in. x 3/4 in. *	1
UXL125428	2 in. x 1 in. *	1
UXL125435	2 in. x 1-1/4 in. *	1
UXL125441	2 in. x 1-1/2 in. *	1

\*For PEX applications, stiffeners are sold separately.

## Water Softener Fitting



Part number	Description	Qty
U086LF	3/4 in. x 1 in. FIP	12

## Radiant Fittings

### Radiant Fitting (non-potable water application)



Part number	Description	Qty
U012	5/8 in. x 5/8 in. Coupling	6
U057	3/4 in. x 5/8 in. Reducing Coupling	6
U126	5/8 in. x 3/4 in. MNPT Reducing Adapter	6
U252	5/8 in. x 5/8 in. Elbow	6
U273	3/4 in. x 5/8 in. Elbow	6
U366	5/8 in. x 5/8 in. x 5/8 in. Tee	6
U516	5/8 in. End Stop	6

# PVC and Polybutylene Transition Fittings

## Polybutylene Transition Coupling



Part number	Description	Qty
U4008LF	1/2 in. PB x 1/2 in. CTS	6
U4016LF	3/4 in. PB x 3/4 in. CTS	6

## Polybutylene Transition Elbow



Part number	Description	Qty
U4248LF	1/2 in. PB x 1/2 in. CTS	6
U4256LF	3/4 in. PB x 3/4 in. CTS	6

## PVC Transition Coupling

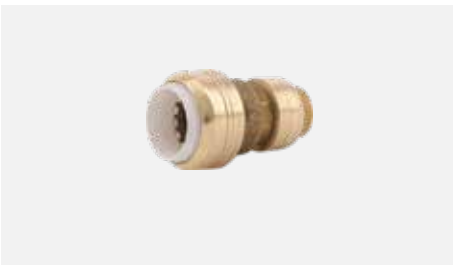

Part number	Description	Qty
UIP4008	1/2 in. CTS x 1/2 in. PVC	6
UIP4016	3/4 in. CTS x 3/4 in. PVC	6
UIP4020	1 in. CTS x 1 in. PVC	3

## PVC Transition Slip Tee



Part number	Description	Qty
UIP363	1/2 in. CTS x 1/2 in. CTS x 1/2 in. PVC	3
UIP364	1/2 in. PVC x 1/2 in. PVC x 1/2 in. CTS	3
UIP371	3/4 in. CTS x 3/4 in. CTS x 3/4 in. PVC	3
UIP372	3/4 in. PVC x 3/4 in. PVC x 3/4 in. CTS	3
UIP375	1 in. CTS x 1 in. CTS x 1 in. PVC	3
UIP376	1 in. PVC x 1 in. PVC x 1 in. CTS	3

## PVC Slip Coupling



Part number	Description	Qty
UIP3008	1/2 in. PVC x 1/2 in. PVC	3
UIP3016	3/4 in. PVC x 3/4 in. PVC	3
UIP3020	1 in. PVC x 1 in. PVC	2

## PVC Male Connector

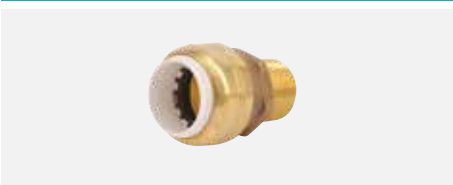

Part number	Description	Qty
UIP120	1/2 in. PVC x 1/2 in. MNPT	6
UIP134	3/4 in. PVC x 3/4 in. MNPT	6
UIP140	1 in. PVC x 1 in. MNPT	3

## PVC Cap



Part number	Description	Qty
UIP514	1/2 in.	12
UIP518	3/4 in.	12
UIP520	1 in.	12

## PVC Depth Gauge and Disconnect Clip



Part number	Description	Qty
UIP710	1/2 in.	12
UIP712	3/4 in.	12
UIP714	1 in.	6

## Flexible Water Heater & Softener Connectors

Used to connect water heaters to the hot and cold water lines. Ideal for working in tight spaces and connecting water heaters with existing pipes that may not line up.

### Stainless Steel Braided Water Heater Connector

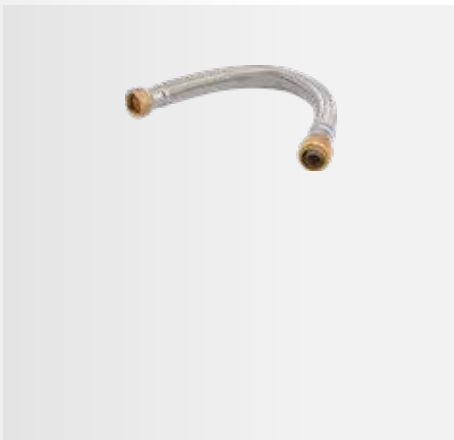

Part number	Description	Qty
U3068FLEX12LF	1/2 in. x 3/4 in. FIP, 12 in.	12
U3068FLEX15LF	1/2 in. x 3/4 in. FIP, 15 in.	12
U3068FLEX18LF	1/2 in. x 3/4 in. FIP, 18 in.	12
U3068FLEX24LF	1/2 in. x 3/4 in. FIP, 24 in.	12
U3088FLEX12LF	3/4 in. x 3/4 in. FIP, 12 in.	12
U3088FLEX15LF	3/4 in. x 3/4 in. FIP, 15 in.	12
U3088FLEX18LF	3/4 in. x 3/4 in. FIP, 18 in.	12
U3088FLEX24LF	3/4 in. x 3/4 in. FIP, 24 in.	12

### Stainless Steel Corrugated Water Heater Connector



Part number	Description	Qty
SS3088FLEX12LF	3/4 in. x 3/4 in. FIP, 12 in.	12
SS3088FLEX18LF	3/4 in. x 3/4 in. FIP, 18 in.	12
SS3088FLEX24LF	3/4 in. x 3/4 in. FIP, 24 in.	12
SS3086FLEX24LF	3/4 in. x 1 in. FIP, 24 in.	6
SS3094FLEX24LF	1 in. x 1 in. FIP, 24 in.	6
SS3096FLEX24LF	1 in. x 3/4 in. FIP, 24 in.	6

### Stainless Steel Braided Water Heater Connector with Ball Valve



Part number	Description	Qty
U3068FLEX18BVLF	1/2 in. x 3/4 in. FIP, 18 in.	12
U3088FLEX18BVLF	3/4 in. x 3/4 in. FIP, 18 in.	12

# Flexible Water Heater & Softener Connectors

## Stainless Steel Corrugated Water Heater Connector with Ball Valve



Part number	Description	Qty
SS3068FLEX18BV	1/2 in. x 3/4 in. FIP, 18 in.	12
SS3088FLEX18BV	3/4 in. x 3/4 in. FIP, 18 in.	12

## Stainless Steel Corrugated Water Heater Connector Kit



Kit contains one 3/4 in. FIP x 3/4 in. SB x 18 in. hose, one 3/4 in. FIP x 3/4 in. SB ball valve x 18 in. hose, and one 3/4 in. disconnect clip

Part number	Description	Qty
24680	Kit	3

## Stainless Steel Braided Water Coupling Hose



Part number	Description	Qty
U3008FLEX18LF	1/2 in. x 1/2 in., 18 in.	12
U3016FLEX18LF	3/4 in. x 3/4 in., 18 in.	12

## Stainless Steel Braided Water Softener Connector



Part number	Description	Qty
U3086FLEX24LF	3/4 in. x 1 in. FIP, 24 in.	6

# Stops & Fixture Supply Fittings

Wide range of supply stops for connecting fixtures and appliances. Used to control and shutoff water flow for maintenance and repair. Compatible with PEX, copper, CPVC, and PE-RT pipe and ideal for working in tight spaces.

## Angle Stop



Part number	Description	Qty
23036-0000LF	1/2 in. x 3/8 in. Compression	12
24731LF	1/2 in. x 3/8 in. Compression Loose Key	6
23048-0000LF	1/2 in. x 1/4 in. (3/8 in. OD)	6
24733LF	1/2 in. x 1/4 in. (3/8 in. OD) Loose Key	6
23336-0000LF	1/2 in. x 1/4 in. Compression	6
24946	1/2 in. x 1/2 in. MIP	6



### Brushed Nickel Angle Stop



Part number	Description	Qty
23036LFBN	1/2 in. X 3/8 in. Compression	1

### Straight Stop



Part number	Description	Qty
23037-0000LF	1/2 in. x 3/8 in. Compression	12
24732LF	1/2 in. x 3/8 in. Compression Loose Key	6
23049-0000LF	1/2 in. x 1/4 in. (3/8 in. OD)	6
24734LF	1/2 in. x 1/4 in. (3/8 in. OD) Loose Key	6
23337-0000LF	1/2 in. x 1/4 in. Compression	6
24947	1/2 in. x 1/2 in. MIP	6

### Tee Stop



Part number	Description	Qty
24983	1/2 in. x 1/2 in. x 1/4 in. Compression	6
24984	1/2 in. x 1/2 in. x 3/8 in. Compression	6
24985	3/4 in. x 3/4 in. x 1/4 in. Compression	6
24986	3/4 in. x 3/4 in. x 3/8 in. Compression	6
24987	1/2 in. x 1/2 in. x 1/4 in. (3/8 in. OD)	6

### Dual Outlet Stop



Part number	Description	Qty
25558LF	1/2 in. Angle Stop x 3/8 in. x 3/8 in. OD Comp Dual Outlet Stop	6

### Dual Shut Off Angle Stop



Part number	Description	Qty
SBDS123838	1/2 in. X 3/8 in. Compression X 3/8 in. Compression	1
SBDS123814	1/2 in. X 3/8 in. Compression X 1/4 in. Compression	1

# Stops & Fixture Supply Fittings

## Dual Tee Stop Valve Adapter



Insert onto stub-out then install any of the eight SharkBite stop valves to create any combination desired. CTS ends insert into any 1/2 in. SB fitting. Recommended use with Angle/Straight Stops.

Part number	Description	Qty
U782LF	1/2 in. CTS x 1/2 in. CTS x 1/2 in.	6

## Stop Valve Connector



Part number	Description	Qty
U3523LF	1/4 in. (3/8 in. OD) x 3/8 in. Compression Stop Valve Connector (Converts 3/8 in. comp stop to SharkBite)	6
U3524LF	1/4 in. (3/8 in. OD) x 1/4 in. Compression Nut	6

## Stop Valve Tee Adapter



Part number	Description	Qty
U3358LF	1/4 in. (3/8 in. OD) x 1/4 in. (3/8 in. OD) x 3/8 in. Compression	6
U4358LF	1/4 in. (3/8 in. OD) x 1/4 in. (3/8 in. OD) x 1/4 in. (3/8 in. OD) Tube	6

## Faucet Connector



Part number	Description	Qty
U3525LF	1/4 in. (3/8 in. OD) x 1/2 in. NPSM	6

## Toilet Connector



Part number	Description	Qty
U3531LF	1/4 in. (3/8 in. OD) x 7/8 in. Ballcock Threads Toilet Connector	6
U3537LF	1/4 in. (3/8 in. OD) x 7/8 in. Ballcock Threads Toilet Elbow	6

## Angle Stop Supply Line



Part number	Description	Qty
24656	1/2 in. x 7/8 in. Ballcock Click Seal® Toilet Connector x 12 in.*	6
24657	1/2 in. x 1/2 in. NPSM Click Seal® Faucet Connector x 20 in.*	6

## Straight Stop Supply Line



Part number	Description	Qty
24686	1/2 in. Straight Stop x 7/8 in. Ballcock Click Seal® Toilet Connector x 16 in.	1
24687	1/2 in. Straight Stop x 1/2 in. NPSM Click Seal® Faucet Connector x 30 in.	1

## Additional Products

### Manifolds with Push-to-Connect Branches



1 in. trunk with 3/4 in. push-to-connect inlets & outlets and 1/2 in. push-to-connect branches.

Part number	Description	Qty
25484Z	Manifold Bracket Set (for 1 in.-1-1/2 in. diameter manifolds)	1
25552LF	3-Port - Open	3
25553LF	3-Port - Closed	3
25554LF	4-Port - Open	3
25555LF	4-Port - Closed	3

### Radiant Heating Manifold (1 in. FNPT x 1/2 in. SharkBite PEX loops)



Part number	Description	Qty
24930	3 Port	1
24931	4 Port	1
24932	5 Port	1
24933	6 Port	1
24934	7 Port	1
24935	8 Port	1
24936	9 Port	1
24937	10 Port	1
24938	11 Port	1
24939	12 Port	1
24940	13 Port	1

### SharkBite Radiant Manifold Actuator



Part number	Description	Qty
24963	SharkBite Radiant Manifold Actuator	1

## Additional Products

### Push-to-Connect Home Run Manifold



Part number	Description	Qty
PM012SB	12 Port with Brass Valves	1
PM024SB	24 Port with Brass Valves	1

### Water Hammer Arrestor



Provides continuous protection against water hammer. Can be positioned vertically or horizontally. Innovative push-to-connect design make for quick and easy installation, even on wet pipe, and ideal for working in tight spaces.

Part number	Description	Qty
22630LF	1/2 in. Residential	1
22631LF	1/2 in. Commercial	1
22632LF	3/4 in. Residential	1
22633LF	1 in. Commercial	1

### Stub-out Elbow



The SharkBite stub-out elbows come with pre-fitted mounting brackets that provide four fixed installation positions on all wooden surfaces (studs, joists and subfloors) by simply rotating or repositioning the mounting bracket.

Part number	Description	Qty
U351LFA	1/2 in. SB x 1/2 in. Copper Tube 8 in. Length	6

### Pressure Gauge



Part number	Description	Qty
24436	1/2 in. SB Tee with Pressure Gauge	1
24438	3/4 in. SB Tee with Pressure Gauge	1
24438A	3/4 in. SB Pressure Gauge in Retail Packaging	5
24440	1 in. SB Tee with Pressure Gauge	1
24442	1/2 in. CTS Pressure Gauge (inserts into any 1/2 in. SB fitting)	1
24444	3/4 in. CTS Pressure Gauge (inserts into any 3/4 in. SB fitting)	1

### Temperature Gauge



Part number	Description	Qty
24437	1/2 in. SB Tee with Temperature Gauge	1
24439	3/4 in. SB Tee with Temperature Gauge	1
24441	1 in. SB Tee with Temperature Gauge	1
24443	1/2 in. CTS Temperature Gauge (inserts into any 1/2 in. SB fitting)	1
24445	3/4 in. CTS Temperature Gauge (inserts into any 3/4 in. SB fitting)	1



# Kits

## Tankless Water Heater Kit



Tankless Water Heater Kit comes with 3/4" Hot Isolation Valve, 3/4" Cold Isolation Valve, 3/4" FWL-2 Pressure Only Relief Valve.

Part number	Description	Qty
25374	3/4" Hot Isolation Valve, 3/4" Cold Isolation Valve, 3/4" FWL-2 Pressure Only Relief Valve	1

## Water Heater Installation Kit



Kits include 2 SharkBite connector fittings and a disconnect clip.

Part number	Description	Qty
22604LF	1/2 in. x 3/4 in. FNPT	12
22441LF	3/4 in. x 3/4 in. FNPT	12

## Contractor Kit



Kits include toolbox.

Part number	Description	Qty
22486LF	Kit Contains 2 each (U008LF, U016LF, U058LF, U072LF, U088LF, U120LF, U134LF, U248LF, U256LF) and 1 each (U362LF, U370LF, U514LF, U518LF, U710, U711, U713 and U702)	1
U3001A	Contractor Tool Box Only	1

## Faucet Connection Kit in Bagged Packaging



Faucet kits come with 2 faucet connectors, 2 angle stops and 1 coil of 10' 1/4 in. White PEX Pipe.

Part number	Description	Qty
25087	Faucet Connector with Angle Stop	3
25538	Faucet Connector with Straight Stop	3

## Toilet Connection Kit in Bagged Packaging



Toilet kits come with 1 toilet connector, 1 angle stop and 1 coil of 5' 1/4 in. White PEX Pipe.

Part number	Description	Qty
25088	Toilet Connector with Angle Stop	6
25539	Toilet Connector with Straight Stop	3

# Kits

## Ice Maker Connection Kit in Bagged Packaging



Ice maker kits come with 1 service slip tee, 1 angle stop, 1 valve connector and 10' 1/4 in. White PEX Pipe.

Part number	Description	Qty
25024	Ice Maker Connector with Angle Stop	1

## Dishwasher Installation Kit in Bagged Packaging



Dishwasher kit comes with 1 dual outlet stop, 1 stop valve connector, 1 dishwasher elbow and 1 garden hose nut.

Part number	Description	Qty
25568	Dishwasher Installation Kit	3

## Shower/Tub Installation Kit in Bagged Packaging



Shower/tub kit contains 2 drop ear elbows, 2 female connectors, 2 female elbows and 1 disconnect clip.

Part number	Description	Qty
25567	Shower/Tub Installation Kit	3

## Water Filter Installation Kit in Bagged Packaging



Water Filter Kit comes with 1 slip coupling, 1 male connector and 1 disconnect clip.

Part number	Description	Qty
25561	Kit contains 1 x 3/4 in. Slip Connector, 1 x 3/4 in. Male Connector, and 1 x 3/4 in. Disconnect Clip	6
25562	Kit contains 1 x 1 in. Slip Connector, 1 x 1 in. Male Connector and 1 x 1 in. Disconnect Clip	6

# Outlet Boxes & Washing Machine Valves

## Ice Maker Outlet Box

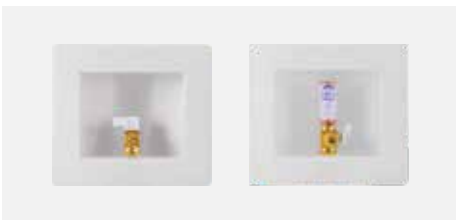

Part number	Description	Qty
25096	1/2 in. SB x 1/4 in. Compression	1
25097	1/2 in. SB x 1/4 in. Compression with Water Hammer Arrestor	1

## Washing Machine Outlet Box



Part number	Description	Qty
25098	1/2 in. SB x 3/4 in. MHT	1
25099	1/2 in. SB x 3/4 in. MHT with Water Hammer Arrestor	1

## Faceplate Replacement



Part number	Description	Qty
25478	Ice Maker Box Replacement Faceplate for 25032, 25033, 25096, 25097	1
25464	Washing Machine Box Replacement Faceplate for 24763, 25031, 25098, 25099	1

## Washing Machine Valve



Part number	Description	Qty
25559LF	1/2 in. x 3/4 in. MHT Straight Valve	6
25560LF	1/2 in. x 3/4 in. MHT Angle Valve	6

# Tools and Accessories

## Deburr & Gauge Tool



Part number	Description	Qty
U702	Use for 1/4 in., 3/8 in., 1/2 in., 5/8 in., 3/4 in. and 1 in. Copper and CPVC Pipe	1
UXLG03	Use for 1-1/4 in., 1-1/2 in., 2 in.	1

## Disconnect Clip



Part number	Description	Qty
U706	1/4 in.	12
U708	3/8 in.	24
U710	1/2 in.	24
U3712	5/8 in.	24
U712	3/4 in.	24
U714	1 in.	12

## Disconnect Tong



Part number	Description	Qty
U711	1/2 in.	1
U713	3/4 in.	1
U715	1 in.	1

## Disconnect Clip

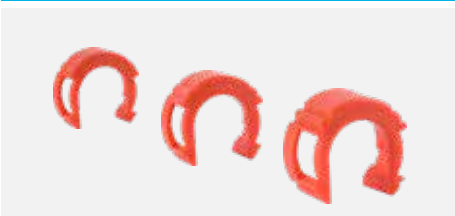

Part number	Description	Qty
UXLDC35	1-1/4 in.	1
UXLDC41	1-1/2 in.	1
UXLDC54	2 in.	1

## Large Diameter PEX Stiffener



Part number	Description	Qty
SBTL35	1-1/4 in.	1
SBTL41	1-1/2 in.	1
SBTL54	2 in.	1

## Wrap for Fitting Burial



Part number	Description	Qty
25406	10' x 2 in. x 0.02 in. Silicone Wrap	1





# Valves

SharkBite manufactures a large range of valves for almost any application, including ball valves, pressure regulating valves, thermostatic mixing valves, check valves, washing machine valves and outdoor hose valves. The innovative push-to-connect design makes them quick and easy to install, as well as compatible with PEX, copper, CPVC, PE-RT and HDPE pipe.





# Ball Valves

## Ball Valve



Part number	Description	Qty
22222-0000LF	1/2 in. x 1/2 in.	12
22185-0000LF	3/4 in. x 3/4 in.	12
22223-0000LF	1 in. x 1 in.	6
UXLBV35	1-1/4 in. x 1-1/4 in. *	1
UXLBV41	1-1/2 in. x 1-1/2 in. *	1
UXLBV54	2 in. x 2 in. *	1

\*For PEX applications, stiffeners are sold separately.

## Ball Valve with FNPT Connector



Part number	Description	Qty
22182-0000LF	1/2 in. x 1/2 in. FNPT	6
22186-0000LF	3/4 in. x 3/4 in. FNPT	6
22187-0000LF	1 in. x 1 in. FNPT	3

## Ball Valve with Drain/Vent



Part number	Description	Qty
22304-0000LF	1/2 in. x 1/2 in. x 1/8 in. NPSM Drain Thread	12
22305-0000LF	3/4 in. x 3/4 in. x 1/8 in. NPSM Drain Thread	12
22306-0000LF	1 in. x 1 in. x 1/8 in. NPSM Drain Thread	6
24377	1/8 in. NPSM Replacement Drain Cap	1

## Ball Valve with Drain/Vent and Mounting Bracket



Part number	Description	Qty
24615-0000LF	1/2 in. x 1/2 in. x 1/8 in. NPSM Drain Thread	12
24616-0000LF	3/4 in. x 3/4 in. x 1/8 in. NPSM Drain Thread	6
24617-0000LF	1 in. x 1 1/8 in. NPSM Drain Thread	6
24377	1/8 in. NPSM Replacement Drain Cap	1

## Slip Ball Valve (Slip end only suitable for copper and CPVC)



Part number	Description	Qty
24735LF	1/2 in. x 1/2 in.	6
24736LF	3/4 in. x 3/4 in.	6
24737LF	1 in. x 1 in.	3

## Reducing Ball Valve



Part number	Description	Qty
22973LF	3/4 in. x 1/2 in.	6
22993LF	1 in. x 3/4 in.	3

## PVC Ball Valve



Part number	Description	Qty
25550LF	3/4 in. PVC x 3/4 in. CTS	6
25551LF	1 in. PVC x 3/4 in. CTS	6

## Outdoor Hose Valves

### Stop Valve with Drain



Part number	Description	Qty
24634LF	1/2 in. x 1/2 in.	12
24635LF	3/4 in. x 3/4 in.	12
24377	1/8 in. NPSM Replacement Drain Cap	1

### Stop Valve Repair Kit



Part number	Description	Qty
25757	Stop Valve Repair Kit	1
24377	1/8 in. NPSM Replacement Drain Cap	1

## Hose Bibbs



Part number	Description	Qty
24620LF	1/2 in. x 3/4 in. MHT 90° – Quarter-Turn	6
24621LF	3/4 in. x 3/4 in. MHT 90° – Quarter-Turn	6
24626LF	1/2 in. x 3/4 in. MHT 90° – Multi-Turn	6
24627LF	3/4 in. x 3/4 in. MHT 90° – Multi-Turn	6
24630LF	1/2 in. x 3/4 in. MHT No-Kink 45° – Quarter-Turn	6
24631LF	3/4 in. x 3/4 in. MHT No-Kink 45° – Quarter-Turn	6
24632LF	1/2 in. x 3/4 in. MHT No-Kink 45° – Multi-Turn	6
24633LF	3/4 in. x 3/4 in. MHT No-Kink 45° – Multi-Turn	6

# Outdoor Hose Valves

## Hose Bibb Repair Kits



Part number	Description	Qty
25756	O-ring Repair Set for Multi Turn Hose Bibbs	1

## Garden Valves

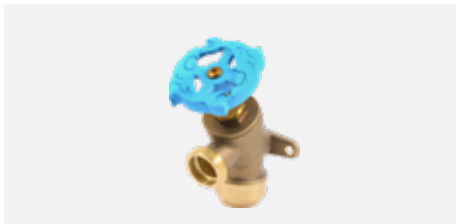

Part number	Description	Qty
24622LF	1/2 in. x 3/4 in. MHT	6
24623LF	3/4 in. x 3/4 in. MHT	6

## Garden Valve Repair Kit



Part number	Description	Qty
25758	Garden Valve Repair Kit	1

## Anti-Siphon Frost-Free Sillcock



Part number	Description	Qty
25743LF	1/2 in. x 3/4 in. MHT 4 in.	4
25744LF	1/2 in. x 3/4 in. MHT 6 in.	4
24628LF	1/2 in. x 3/4 in. MHT 8 in.	4
24629LF	1/2 in. x 3/4 in. MHT 10 in.	4
24636LF	1/2 in. x 3/4 in. MHT 12 in.	4
24637LF	1/2 in. x 3/4 in. MHT 15 in.	4
24638LF	1/2 in. x 3/4 in. MHT 18 in.	4

## Anti-Siphon Frost-Free Sillcock Repair Kit



Part number	Description	Qty
25759	Vacuum Breaker Repair Kit	1
25773	4 in. Steam Repair Kit	1
25774	6 in. Steam Repair Kit	1
25751	8 in. Steam Repair Kit	1
25752	10 in. Steam Repair Kit	1
25753	12 in. Steam Repair Kit	1
25754	15 in. Steam Repair Kit	1
25755	18 in. Steam Repair Kit	1

## Pressure Regulating Valves

### EB45 Lead Free SharkBite Connection



Part number	Description	Qty
23807-0045	1/2 in. EB45-DSB Direct SharkBite	1
24383-0045	1/2 in. EB45-SDSB Slip Feature Direct SharkBite	1
23893-0045	1/2 in. EB45-DUSB Double Union SharkBite	1
24476-0045	1/2 in. EB45-DUSB Double Union SharkBite with Metal Top	1
23808-0045	3/4 in. EB45-DSB Direct SharkBite	1
24384-0045	3/4 in. EB45-SDSB Slip Feature Direct SharkBite	1
23894-0045	3/4 in. EB45-DUSB Double Union SharkBite	1
23896-0060	3/4 in. EB45 Double Union SharkBite (60 psi setting)	1
24449-0045	3/4 in. EB45-DUSB Double Union SharkBite with Gauge	1
24477-0045	3/4 in. EB45-DUSB Double Union SharkBite with Metal Top	1
22675-0045	1 in. EB45-DSB Direct SharkBite	1
23358-0045	1 in. EB45-DUSB Double Union SharkBite	1
23945-0060	1 in. EB45-DUSB Double Union SharkBite (60 psi setting)	1
25847-0045	1-1/4 in. EB45 Double Union SharkBite	1
25848-0045	1-1/2 in. EB45 Double Union SharkBite	1
25849-0045	2 in. EB45 Double Union SharkBite	1

All EB45 valves factory set at 45 psi unless specified.

### EB25 Lead Free SharkBite Connection



Part number	Description	Qty
23955-0045	3/4 in. EB25-DUSB Double Union SharkBite	1
23956-0045	1 in. EB25-DUSB Double Union SharkBite	1
25844-0045	1-1/4 in. EB25 Double Union SharkBite	1
25845-0045	1-1/2 in. EB25 Double Union SharkBite	1
25846-0045	2 in. EB25 Double Union SharkBite	1

### A-89 Boiler Feed Valve



Part number	Description	Qty
25521Z	1/2 in. A-89 Direct SharkBite	1

## Thermostatic Mixing Valves

### HG110-D Lead Free



Part number	Description	Qty
24548	1/2 in. HG110-D with Integrated SharkBite Connections and Integral Checks	1
24549	3/4 in. HG110-D with Integrated SharkBite Connections and Integral Checks	1
24504	1/2 in. HG110-D with SharkBite Union Connections	1
24505	3/4 in. HG110-D with SharkBite Union Connections	1

ASSE 1017, 1069 & 1070, CSA B 125.3. Distribution and in-line.



# Thermostatic Mixing Valves

## HG160 Lead Free



Part number	Description	Qty
24529	1/2 in. HG160 with SharkBite Connections	1
24530	3/4 in. HG160 with SharkBite Connections	1

ASSE 1017, 1069 & 1070, CSA B 125.3. Distribution and in-line.

## HG110-HX



Part number	Description	Qty
24867	3/4 in. HG110-HX with SharkBite Connections and Integral Checks	1

# Check Valves

## Check Valve



Used to prevent the reverse flow of water.

Part number	Description	Qty
U2008-0000LF	1/2 in. x 1/2 in.	6
U2016-0000LF	3/4 in. x 3/4 in.	6
U2020-0000LF	1 in. x 1 in.	3

## Dual Check Valve



Part number	Description	Qty
BF13434SB	3/4 in. x 3/4 in.	1
BF10101SB	1 in. x 1 in.	1
BF5M0134SB	1 in. x 3/4 in.	1
BF5M1401SB	1-1/4 in. x 1 in.	1

ASSE 1024 & CSA B64.6

# Thermal Expansion Relief Valve

## Thermal Expansion Relief Valve



Part number	Description	Qty
25704LF	3/4 in. x 3/4 in. x 1/2 in. Outlet	1

# Temperature & Pressure Relief Valves

Provides temperature and pressure protection for residential water heaters and storage tanks. Push-to-connect design allows for quick and easy installation on copper and CPVC drain lines. Comes with standard factory settings of 150 psi for pressure and 210°F (99°C) for temperature relief. Completely automatic and reseats after temperature or pressure relief.

## Temperature & Pressure Relief Valve



Part number	Description	Qty
24609-0150	3/4 in. NCLX-5LX with SharkBite Outlet Connection	1



# EvoPEX Fittings

Designed for new construction and larger renovation projects, SharkBite EvoPEX push-to-connect fittings and SharkBite PEX pipe deliver the ability to plumb an entire potable water system without the need for special tools. This revolutionary system provides a faster, safer and more reliable installation for long-term use and satisfaction. It extends beyond the traditional pipe and fittings solutions to include fittings, PEX pipe, valves, supply stops and other accessories.

## Keep to schedule

No special tools, crimping, glue or solder to plumb an entire home, optimizing install time and efficiency. Fittings can be securely rotated after installation for quick alignment.

## Mitigate risk

The system's ease of installation reduces the risk of install errors, which minimizes potential leaks. A green visual indicator provides instant assurance that a secure and permanent connection has been made.

For use on SharkBite PEX pipe only. Not compatible with copper or CPVC pipe.





# EvoPEX Rough Plumbing Fittings

## Coupling



Part number	Description	Bag qty	Minimum order qty
K008WP3	1/2 in.	3	1
K016WP3	3/4 in.	3	1
K020WP2	1 in.	2	1

For use on SharkBite PEX pipe only.

## Reducing Coupling



Part number	Description	Bag qty	Minimum order qty
K058WP3	3/4 in. x 1/2 in.	3	1
K060WP2	1 in. x 3/4 in.	2	1

For use on SharkBite PEX pipe only.

## Female Adapter



Part number	Description	Bag qty	Minimum order qty
K072WP3	1/2 in. x FNPT	3	1
K088WP3	3/4 in. x FNPT	3	1
K094WP2	1 in. x FNPT	2	1

For use on SharkBite PEX pipe only.

## Male Adapter



Part number	Description	Bag qty	Minimum order qty
K120WP3	1/2 in. x MNPT	3	1
K134WP3	3/4 in. x MNPT	3	1
K140WP2	1 in. x MNPT	2	1

For use on SharkBite PEX pipe only.

## Elbow



Part number	Description	Bag qty	Minimum order qty
K248WP6	1/2 in. x 1/2 in.	6	1
K256WP6	3/4 in. x 3/4 in.	6	1
K260WP2	1 in. x 1 in.	2	1

For use on SharkBite PEX pipe only.

## Reducing Elbow



Part number	Description	Bag qty	Minimum order qty
K274WP3	1/2 in. x 3/4 in.	3	1
K277WP2	1 in. x 1/2 in.	2	1

For use on SharkBite PEX pipe only.

## Male Elbow



Part number	Description	Bag qty	Minimum order qty
K280WP2	1/2 in. x MNPT	2	1

For use on SharkBite PEX pipe only.

## Female Elbow



Part number	Description	Bag qty	Minimum order qty
K308WP2	1/2 in. x FNPT Elbow	2	1

For use on SharkBite PEX pipe only.

## Drop-Ear Elbow



Part number	Description	Bag qty	Minimum order qty
K334WP3	1/2 in. x FNPT	3	1
K340WP2	3/4 in. x FNPT	2	1

For use on SharkBite PEX pipe only.

## Tee



Part number	Description	Bag qty	Minimum order qty
K362WP3	1/2 in. x 1/2 in. x 1/2 in.	3	1
K370WP3	3/4 in. x 3/4 in. x 3/4 in.	3	1
K374WP2	1 in. x 1 in. x 1 in.	2	1

For use on SharkBite PEX pipe only.

## Reducing Street Tee



Part number	Description	Bag qty	Minimum order qty
K4483WP3	3/4 in. x 3/4 in. x 1/2 in.	3	1
K4485WP2	1 in. x 1 in. x 1/2 in.	2	1

For use on SharkBite PEX pipe only.



# EvoPEX Rough Plumbing Fittings

## Reducing Tee



Part number	Description	Bag qty	Minimum order qty
K408WP3	1/2 in. x 1/2 in. x 3/4 in.	3	1
K412WP3	3/4 in. x 3/4 in. x 1/2 in.	3	1
K413WP2	3/4 in. x 3/4 in. x 1 in.	2	1
K414WP2	1 in. x 3/4 in. x 3/4 in.	2	1
K415WP2	1 in. x 1 in. x 1/2 in.	2	1
K416WP2	1 in. x 1 in. x 3/4 in.	2	1
K418WP2	1 in. x 3/4 in. x 1 in.	2	1
K419WP2	1 in. x 3/4 in. x 1/2 in.	2	1
K444WP3	3/4 in. x 1/2 in. x 3/4 in.	3	1
K454WP3	3/4 in. x 1/2 in. x 1/2 in.	3	1

For use on SharkBite PEX pipe only.

## End Cap



Part number	Description	Bag qty	Minimum order qty
K514WP6	1/2 in.	6	1
K518WP6	3/4 in.	6	1
K520WP2	1 in.	2	1

For use on SharkBite PEX pipe only.

## PEX Stub-out Kit



Part number	Description	Bag qty	Minimum order qty
K25578WP12	1/2 in. x 6 in. with Bracket and EvoPEX 1/2 in. 90	12	1
K25581WP12	1/2 in. x 6 in. with EvoPEX 1/2 in. 90	12	1
K25721WP12	1/2 in. x 10 in. with Bracket, Cap and EvoPEX 1/2 in. 90	12	1
K25722WP12	1/2 in. x 10 in. with Cap and EvoPEX 1/2 in. 90	12	1

For use on SharkBite PEX pipe only.

## PEX Stub-out

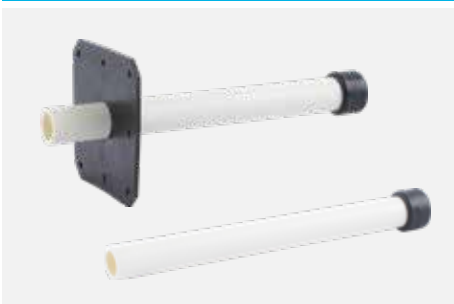

Part number	Description	Bag qty	Minimum order qty
K24649WP	1/2 in. x 6 in. with Bracket	25	25
K24650WP	1/2 in. x 6 in.	25	25
K25721WP	1/2 in. x 10 in. with Bracket and Cap	25	25
K25722WP	1/2 in. x 10 in. with Cap	25	25
K25723WP	1/2 in. x 20 in. with Bracket and Cap	25	25

For use on SharkBite PEX pipe only.

## Copper Stub-out



Part number	Description	Bag qty	Minimum order qty
K25811	1/2 in. x 6 in. with Bracket & EvoPEX Elbow	12	12
K25813	1/2 in. x 6 in. with EvoPEX Elbow	12	12
K25815	1/2 in. x 8 in. with Bracket & EvoPEX Elbow	12	12
K25817	1/2 in. x 8 in. with EvoPEX Elbow	12	12

For use on SharkBite PEX pipe only.

## Supply Stops

### Angle Stop



Part number	Description	Bag qty	Minimum order qty
K23036	1/2 in. x 3/8 in. Compression with Escutcheon	1	12

For use on SharkBite PEX pipe only.

### Straight Stop



Part number	Description	Bag qty	Minimum order qty
K23037	1/2 in. x 3/8 in. Compression with Escutcheon	1	12

For use on SharkBite PEX pipe only.

## Ball Valves

### Ball Valve



Part number	Description	Bag qty	Minimum order qty
K22222	1/2 in. x 1/2 in.	1	12
K22185	3/4 in. x 3/4 in.	1	12
K22223	1 in. x 1 in.	1	6

For use on SharkBite PEX pipe only.



# PEX Crimp & Clamp Fittings

SharkBite manufactures a wide selection of brass and poly crimp fittings, tools and accessories. Certified for potable water and radiant heating applications and can be used to connect PEX pipe with copper crimp rings or stainless steel clamps.





# PEX Brass Rough Plumbing Fittings

## Coupling



Part number	Description	Qty
UC006LF	3/8 in. x 3/8 in.	10
UC008LF	1/2 in. x 1/2 in.	25
UC012LF	5/8 in. x 5/8 in.	10
UC016LF	3/4 in. x 3/4 in.	25
UC020LF	1 in. x 1 in.	10
UC0135	1-1/4 in. x 1-1/4 in.	20
UC0141	1-1/2 in. x 1-1/2 in.	20
UC0154	2 in. x 2 in.	15

## Reducing Coupling



Part number	Description	Qty
UC009LF	3/8 in. x 1/2 in.	10
UC058LF	1/2 in. x 3/4 in.	25
UC057LF	3/4 in. x 5/8 in.	10
UC060LF	3/4 in. x 1 in.	25
UC013522	1-1/4 in. x 3/4 in.	20
UC013528	1-1/4 in. x 1 in.	20
UC014122	1-1/2 in. x 3/4 in.	15
UC014128	1-1/2 in. x 1 in.	20
UC014135	1-1/2 in. x 1-1/4 in.	20
UC015441	2 in. x 1-1/2 in.	20

## Threaded Female Adapter

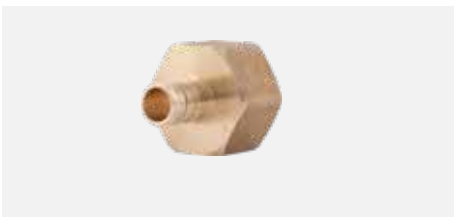

Part number	Description	Qty
UC068LF	1/2 in. x 3/4 in. FNPT	25
UC072LF	1/2 in. x 1/2 in. FNPT	25
UC092LF	3/4 in. x 1/2 in. FNPT Bullnose	25
UC088LF	3/4 in. x 3/4 in. FNPT	25
UC094LF	1 in. x 1 in. FNPT	10
UC113532F	1-1/4 in. x 1-1/4 in. FNPT Lead Free	10
UC114140F	1-1/2 in. x 1-1/2 in. FNPT Lead Free	10
UC115450F	2 in. x 2 in. FNPT Lead Free	10

## Threaded Male Adapter

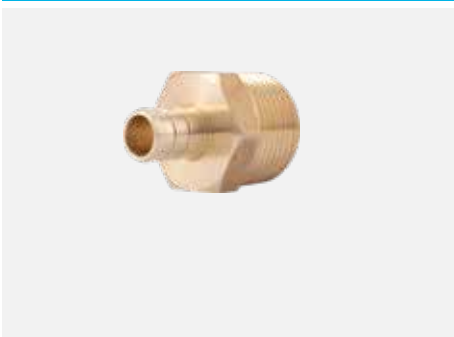

Part number	Description	Qty
UC118LF	3/8 in. x 1/2 in. MNPT	10
UC120LF	1/2 in. x 1/2 in. MNPT	25
UC116LF	1/2 in. x 3/4 in. MNPT	25
UC138LF	3/4 in. x 1/2 in. MNPT	25
UC134LF	3/4 in. x 3/4 in. MNPT	25
UC139LF	3/4 in. x 1 in. MNPT	10
UC142LF	1 in. x 3/4 in. MNPT	10
UC140LF	1 in. x 1 in. MNPT	10
UC113532M	1-1/4 in. x 1-1/4 in. MNPT Lead Free	10
UC114140M	1-1/2 in. x 1-1/2 in. MNPT Lead Free	10
UC115450M	2 in. x 2 in. MNPT Lead Free	10

## Sweat Female Adapter



Part number	Description	Qty
UC600LF	1/2 in. x 1/2 in.	25
UC606LF	3/4 in. x 3/4 in.	25
UC605LF	1 in. x 1 in.	10

## Sweat Male Adapter



Part number	Description	Qty
UC607LF	1/2 in. x 1/2 in.	25
UC608LF	3/4 in. x 3/4 in.	25
UC609LF	1 in. x 1 in.	10

## Elbow



Part number	Description	Qty
UC246LF	3/8 in. x 3/8 in.	10
UC248LF	1/2 in. x 1/2 in.	25
UC256LF	3/4 in. x 3/4 in.	25
UC260LF	1 in. x 1 in.	10
UC0235	1-1/4 in. x 1-1/4 in.	10
UC0241	1-1/2 in. x 1-1/2 in.	10
UC0254	2 in. x 2 in.	10

## Reducing Elbow

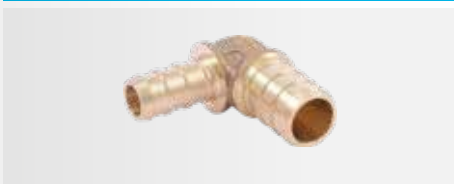

Part number	Description	Qty
UC272LF	1/2 in. x 3/8 in.	10
UC274LF	1/2 in. x 3/4 in.	25
UC273LF	3/4 in. x 5/8 in.	10

## Drop-Ear Elbow



Part number	Description	Qty
UC334LF	1/2 in. x 1/2 in. FNPT	25
UC340LF	3/4 in. x 3/4 in. FNPT	25
UC342LF	3/4 in. x 1/2 in. FNPT	25

## Adapter Elbow



Part number	Description	Qty
UC280LF	1/2 in. x 1/2 in. MNPT	25
UC278LF	1/2 in. x 3/4 in. MNPT	25
UC286LF	3/4 in. x 3/4 in. MNPT	25
UC626LF	3/4 in. x 3/4 in. Female Sweat	25
UC628LF	3/4 in. x 3/4 in. Male Sweat	25



# PEX Brass Rough Plumbing Fittings

## Tee



Part number	Description	Qty
UC360LF	3/8 in. x 3/8 in. x 3/8 in.	10
UC362LF	1/2 in. x 1/2 in. x 1/2 in.	25
UC370LF	3/4 in. x 3/4 in. x 3/4 in.	25
UC374LF	1 in. x 1 in. x 1 in.	10
UC0835	1-1/4 in. x 1-1/4 in. x 1-1/4 in.	10
UC0841	1-1/2 in. x 1-1/2 in. x 1-1/2 in.	5
UC0854	2 in. x 2 in. x 2 in.	5

## Bullnose Tee



Part number	Description	Qty
UC408LF	1/2 in. x 1/2 in. x 3/4 in.	25
UC413LF	3/4 in. x 3/4 in. x 1 in.	10

## Reducing Tee



Part number	Description	Qty
UC364LF	3/8 in. x 3/8 in. x 1/2 in.	10
UC452LF	1/2 in. x 3/8 in. x 3/8 in.	10
UC363LF	1/2 in. x 1/2 in. x 3/8 in.	10
UC434LF	1/2 in. x 3/8 in. x 1/2 in.	10
UC417LF	3/4 in. x 3/4 in. x 3/8 in.	10
UC412LF	3/4 in. x 3/4 in. x 1/2 in.	25
UC454LF	3/4 in. x 1/2 in. x 1/2 in.	25
UC444LF	3/4 in. x 1/2 in. x 3/4 in.	25
UC414LF	1 in. x 3/4 in. x 3/4 in.	10
UC415LF	1 in. x 1 in. x 1/2 in.	10
UC416LF	1 in. x 1 in. x 3/4 in.	10
UC418LF	1 in. x 3/4 in. x 1 in.	10
UC08352828	1-1/4 in. x 1 in. x 1 in.	10
UC08353516	1-1/4 in. in. x 1-1/4 in. x 1/2 in.	10
UC08353522	1-1/4 in. x 1-1/4 in. x 3/4 in.	10
UC08353528	1-1/4 in. x 1-1/4 in. x 1 in.	10
UC08413528	1-1/2 in. x 1-1/2 in. x 1 in.	5
UC08414116	1-1/2 in. x 1-1/2 in. x 1/2 in.	5
UC08414122	1-1/2 in. x 1-1/2 in. x 3/4 in.	10
UC08414128	1-1/2 in. x 1-1/2 in. x 1 in.'	5
UC08414135	1-1/2 in. x 1-1/2 in. x 1-1/4 in.	5
UC08545416	2 in. x 2 in. x 1/2 in.	5
UC08545422	2 in. x 2 in. x 3/4 in.	5
UC08545428	2 in. x 2 in. x 1 in.	5
UC08545441	2 in. x 2 in. x 1-1/2 in.	5

## Swivel Adapter

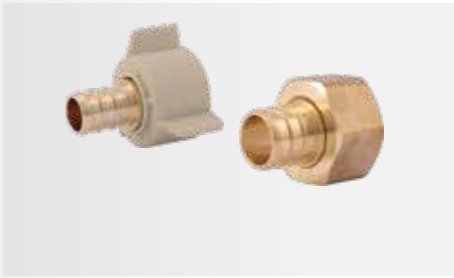

Part number	Description	Qty
UC527LF	3/8 in. x 3/8 in. FNPT	10
UC526LF	1/2 in. x 1/2 in. FNPT	25
UC534LF	1/2 in. x 3/4 in. FNPT	25
UC530LF	3/4 in. x 3/4 in. FNPT	25
UC529LF	3/4 in. x 1 in. FNPT	10
UC594LF	1 in. x 1 in. FNPT	10

## Swivel Elbow



Part number	Description	Qty
UC531LF	3/8 in. x 1/2 in. MNPT	10
UC532LF	1/2 in. x 1/2 in. MNPT	25

## Swivel Toilet Connectors



Part number	Description	Qty
UC528LF	1/2 in. x 7/8 in. BC Straight	10
23067LF	1/2 in. x 7/8 in. BC Elbow	6

## Plug



Part number	Description	Qty
UC512LF	3/8 in.	10
UC514LF	1/2 in.	25
UC518LF	3/4 in.	25
UC520LF	1 in.	10
UC0435	1-1/4 in.	40
UC0441	1-1/2 in.	30
UC0454	2 in.	20

# PEX Transition Fittings

## Polybutylene Transition Coupling (with PB crimp ring)

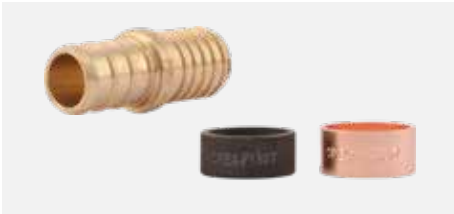

Part number	Description	Qty
UC4006LF	3/8 in. x 3/8 in.	10
UC4008LF	1/2 in. x 1/2 in.	25
UC4016LF	3/4 in. x 3/4 in.	25

# PEX Poly Rough Plumbing Fittings

Corrosion resistant fittings certified for use in potable water and hydronic heating applications.

## Coupling



Part number	Description	Qty
UP008	1/2 in. x 1/2 in.	25
UP016	3/4 in. x 3/4 in.	25
UP020	1 in. x 1 in.	25

## Reducing Coupling



Part number	Description	Qty
UP058	3/4 in. x 1/2 in.	25
UP060	1 in. x 3/4 in.	25

## Connector



Part number	Description	Qty
UP120	1/2 in. x 1/2 in. MNPT	25
UP134	3/4 in. x 3/4 in. MNPT	25
UP138	3/4 in. x 1/2 in. MNPT	25
UP140	1 in. x 1 in. MNPT	25

## Elbow



Part number	Description	Qty
UP248	1/2 x 1/2 in.	25
UP256	3/4 in. x 3/4 in.	25
UP260	1 in. x 1 in.	25

## Male Elbow



Part number	Description	Qty
UP280	1/2 in. x 1/2 in. MNPT	25

## Reducing Elbow



Part number	Description	Qty
UP274	3/4 in. x 1/2 in.	25

## Tee



Part number	Description	Qty
UP360	3/8 in. x 3/8 in. x 3/8 in.	10
UP362	1/2 in. x 1/2 in. x 1/2 in.	25
UP370	3/4 in. x 3/4 in. x 3/4 in.	25
UP374	1 in. x 1 in. x 1 in.	25

## Reducing Tee



Part number	Description	Qty
UP408	1/2 in. x 1/2 in. x 3/4 in.	25
UP454	3/4 in. x 1/2 in. x 1/2 in.	25
UP412	3/4 in. x 3/4 in. x 1/2 in.	25
UP444	3/4 in. x 1/2 in. x 3/4 in.	25
UP414	1 in. x 3/4 in. x 3/4 in.	25
UP415	1 in. x 1 in. x 1/2 in.	25
UP416	1 in. x 1 in. x 3/4 in.	25

## Plug



Part number	Description	Qty
UP514	1/2 in.	25
UP518	3/4 in.	25
UP520	1 in.	25

## Adapter



Part number	Description	Qty
UP526	1/2 in. x 1/2 in. FIP Swivel	25
UP527	3/8 in. x 1/2 in. FIP Swivel	10
UP532	1/2 in. x 1/2 in. FIP Swivel Elbow	25

## Poly Multi-Port Tee 3 Port



Part number	Description	Qty
UPMPT3O	Poly Multi-Port Tee 3 Port Open	12
UPMPT3C	Poly Multi-Port Tee 3 Port Closed	12

# PEX Poly Rough Plumbing Fittings

## Poly Multi-Port Tee 4 Port



Part number	Description	Qty
UPMPT4O	Poly Multi-Port Tee 4 Port Open	12
UPMPT4C	Poly Multi-Port Tee 4 Port Closed	12

## PEX Supply Stops

### PEX Chrome Plated Quarter Turn Angle Stop



Part number	Description	Qty
23058LF	1/2 in. x 3/8 in. OD Compression (Quarter Turn)	24
23056LF	1/2 in. x 1/4 in. OD Compression (Quarter Turn)	6

### PEX Chrome Plated Quarter Turn Straight Stop



Part number	Description	Qty
23382LF	3/8 in. x 3/8 in. (Quarter Turn)	6
23057LF	1/2 in. x 3/8 in. OD Compression (Quarter Turn)	24

### PEX Chrome Plated Straight Stop



Part number	Description	Qty
23059LF	1/2 in. x 3/8 in. Compression	24
23062LF	1/2 in. x 3/8 in.	6
23061LF	1/2 in. x 1/2 in. MPT	6
23063LF	1/2 in. x 1/2 in.	12

### PEX Chrome Plated Angle Stop



Part number	Description	Qty
23060LF	1/2 in. x 3/8 in. Compression	12
23064LF	1/2 in. x 3/4 in. MHT	6

### PEX Chrome Plated Angle Dual Outlet Stop



Part number	Description	Qty
23066LF	1/2 in. x 3/8 in. x 3/8 in. Compression	6

# PEX Stub-outs, Manifolds & Arrestors

## Copper Stub-out Elbow



All copper stub-out elbows are lead free.

Part number	Description	Qty
22791	1/2 in. x Closed (4 in. x 8 in.)	12
23069	3/8 in. x 1/2 in. (4 in. x 4 in.)	6
23070	1/2 in. x 1/2 in. (4 in. x 4 in.)	6
25094	1/2 in. x Closed (4 in. x 8 in.) with Bracket	1

## Copper Manifold with Barb Branches



1 in. trunk with 3/4 in. barb inlets & outlets and 1/2 in. barb ports - 2 in. on center, lead free

Part number	Description	Qty
25484Z	Manifold Bracket Set (for 1 in.-1-1/2 in. diameter manifolds)	1
22783	3 Port Closed	1
22784	3 Port Open	1
22785	4 Port Closed	1
22786	4 Port Open	1
22787	6 Port Closed	1
22788	6 Port Open	1
22789	8 Port Closed	1
22790	8 Port Open	1

## Water Hammer Arrestor

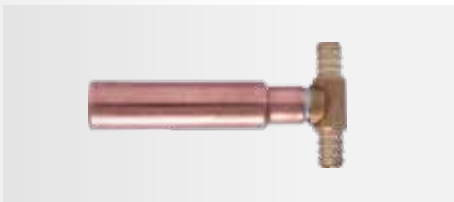

Provides maintenance-free, continuous protection against water hammer. Can be positioned vertically or horizontally.

Part number	Description	Qty
25401	1/2 in. Residential	1

## Barb and Poly Home Run Manifold

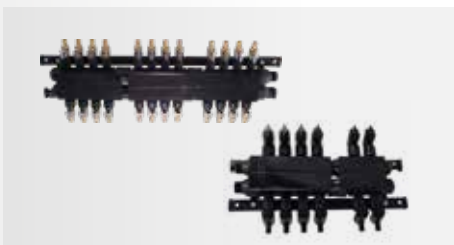

Part number	Description	Qty
RM22712	12 Port with Brass Ball Valves	1
RM22724	24 Port with Brass Ball Valves	1
PM012UP	12 Port with Poly Ball Valves	1
PM024UP	24 Port with Poly Ball Valves	1

# PEX Ball Valves

## Barb Ball Valve



Part number	Description	Qty
22461LF	1/2 in. x 1/2 in.	12
22462LF	3/4 in. x 3/4 in.	12
22463LF	1 in. x 1 in.	6

# PEX Ball Valves

## Barb Ball Valve with Drain / Vent



Part number	Description	Qty
24612LF	1/2 in. x 1/2 in. x 1/8 in. NPSM Drain Thread	6
24613LF	3/4 in. x 3/4 in. x 1/8 in. NPSM Drain Thread	6
24377	1/8 in. NPSM Replacement Drain Cap	1

# PEX Outlet Boxes & Washing Machine Valves

## Brass Crimp Washing Machine Outlet Box

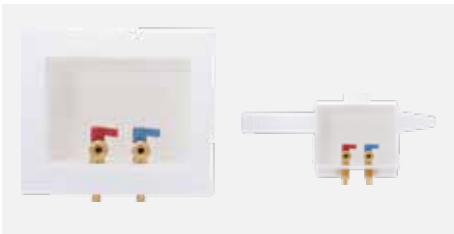

Part number	Description	Qty
25739	1/2 in. x 3/4 in. MHT	1

## Brass Crimp Icemaker Outlet Box



Part number	Description	Qty
25740	1/2 in. x 1/4 in. Compression	1

## Faceplate Replacements

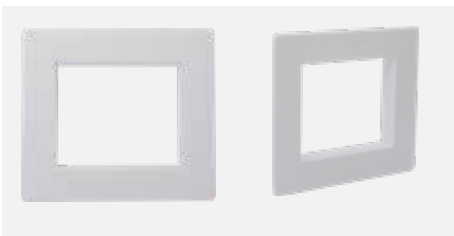

Part number	Description	Qty
25478	Ice Maker Box Replacement Faceplate for 25032, 25033, 25096, 25097, 25739	1
25464	Washing Machine Box Replacement Faceplate for 24763, 25031, 25098, 25099, 25740	1

## Washing Machine Valves

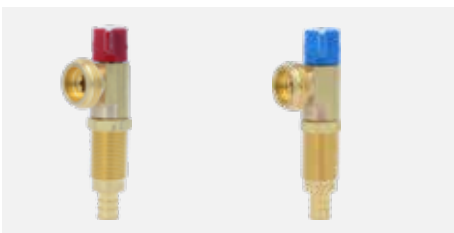

Part number	Description	Qty
24998A	1/2 in. Red Handle	1
24813A	1/2 in. Blue Handle	1



## Tools & Accessories

### Clamp Ring (stainless steel)



Part number	Description	Qty
UC952	3/8 in.	100
UC953	1/2 in.	100
UC954	5/8 in.	50
UC955	3/4 in.	100
UC956	1 in.	50

### Crimp Ring (copper)



Part number	Description	Qty
23101CP25	3/8 in. (25 Pack)	6
23101CP100	3/8 in. (100 Pack)	6
23102CP25	1/2 in. (25 Pack)	24
23102CP100	1/2 in. (100 Pack)	6
23103CP25	3/4 in. (25 Pack)	12
23103CP100	3/4 in. (100 Pack)	6
23104CP25	1 in. (25 Pack)	6
23101	3/8 in.	100
23102	1/2 in.	100
23103	3/4 in.	100
24676	1-1/4 in.	50
24677	1-1/2 in.	50
24678	2 in.	20

### Pex Bend Support, Suspension Clamp and Insulator



Part number	Description	Qty
23065	3/8 in. J Hook PEX Pipe Clamp (10 Pack)	12
23220	1/2 in. J Hook PEX Pipe Clamp (10 Pack)	12
23220Z100	1/2 in. J Hook PEX Pipe Clamp (100 Pack)	5
23221	3/4 in. J Hook PEX Pipe Clamp (10 Pack)	12
23071A10	1/2 in. Insulated Suspension Clamp (10 Pack)	6
23072A10	3/4 in. Insulated Suspension Clamp (10 Pack)	6
23073A10	1 in. Insulated Suspension Clamp (10 Pack)	6
23074A10	1/2 in. Pipe Insulator (10 Pack)	6
23075A10	3/4 in. Pipe Insulator (10 Pack)	6
23076A10	1 in. Pipe Insulator (10 Pack)	6
23050	1/2 in. Polymer Bend Support with mounting bracket	12
23051	3/4 in. Polymer Bend Support	6
23053	1/2 in. Metal Pipe Support	12
23054	3/4 in. Metal Pipe Support	12

### Radiant Installation Component



Part number	Description	Qty
25485Z25	1/2 in. PEX Wire Mesh Installation Clips (25 Pack)	1
25486Z25	1/2 in. PEX Foam Insulation Twist Clips (25 Pack)	1
25490Z	1/2 in. PEX Conduit Slab Support	10

# Tools & Accessories

## PEX Crimp Tool



Part number	Description	Qty
23251	1/2 in., 3/4 in. PEX Combo Crimp Tool	1
23383	3/8 in., 1/2 in., 3/4 in. PEX Pocket Crimp Tool	1

## PEX Crimp Tool Kit



Part number	Description	Qty
23100	3/8 in., 1/2 in., 3/4 in., 1 in. PEX Crimp Ring Tool Kit (Crimp Ring Gauge included)	1
24675	1-1/4 in., 1-1/2 in., 2 in. Crimp Tool	1

## PEX Clamp Tool



Part number	Description	Qty
UC961	PEX Clamp Tool One-hand Operation	1
23081	PEX Clamp Tool Standard Handles	1

## Crimp Ring Gauge



Part number	Description	Qty
23080	3/8 in., 1/2 in., 3/4 in., 1 in. PEX Crimp Ring Gauge	6

## Crimp Ring Removal Tool



Part number	Description	Qty
23055	PEX Crimp Ring Removal Tool	6

## PEX Decoiler



Part number	Description	Qty
UFH034	PEX Decoiler	1

## PEX Pipe Cutter



Part number	Description	Qty
U701	PEX Pipe Cutter	1
25880	Pro PEX Cutter 1/4 in. - 1 in.	1
23369	Radial PEX cutter 1/2 in. - 1 in.	1



# PEX Pipe

## The benefits of SharkBite PEX

SharkBite PEX pipe is a cost-effective piping solution approved for use in both hot and cold plumbing installations. Compared to rigid pipe, PEX pipe is faster to install and its flexibility to bend around corners allows for longer runs and fewer connections - reducing cost, time and potential leak points. It is also a freeze resistant pipe that can expand slightly if frozen and contract when thawed. SharkBite PEX pipe offers the highest rating for chlorine resistance and a six-month UV resistance, the highest available. It is approved for water service lines and burial applications, including being buried in concrete. With more than 850 million feet of PEX pipe installed in North America, SharkBite PEX pipe is proven and guaranteed.





## Discover the flexibility and benefits of SharkBite PEX Pipe

### **Cost Savings and Flexibility**

Flexibility to bend around corners allowing for longer runs with fewer connections, which saves cost, allows for faster installations and reduces potential leak points.

### **Freeze Resistant**

PEX systems are less susceptible to burst in freezing conditions due to the pipe's ability to expand and contract.

### **Chlorine and UV Resistance**

SharkBite PEX has a 5306 rating, giving it a UV rating of 6 months. It also has the highest chlorine resistance rating.

### **Health and Safety**

No torches, glue or solvents required for installation, which keeps potentially dangerous chemicals out of the potable water supply.

### **Proven and Guaranteed**

SharkBite PEX pipe has been around for more than 35 years with over 12 billion feet of pipe installed worldwide.

# Potable Water PEX Pipe

## PEX Pipe (coils)



Part number White	Part number Red	Part number Blue	Size	Qty
U850W50			1/4 in. (3/8 in. OD) x 50'	1
U855W50			3/8 in. x 50'	1
U855W100	U855R100	U855B100	3/8 in. x 100'	1
U860W25	U860R25	U860B25	1/2 in. x 25'	1
U860W50	U860R50	U860B50	1/2 in. x 50'	1
U860W100	U860R100	U860B100	1/2 in. x 100'	1
U860W300	U860R300	U860B300	1/2 in. x 300'	1
U860W500	U860R500	U860B500	1/2 in. x 500'	1
U870W25	U870R25	U870B25	3/4 in. x 25'	1
U870W50	U870R50	U870B50	3/4 in. x 50'	1
U870W100	U870R100	U870B100	3/4 in. x 100'	1
U870W300	U870R300	U870B300	3/4 in. x 300'	1
U870W500	U870R500	U870B500	3/4 in. x 500'	1
U880W100	U880R100	U880B100	1 in. x 100'	1
U880W300	U880R300	U880B300	1 in. x 300'	1
U880W500	U880R500	U880B500	1 in. x 500'	1
U885W100			1-1/4 in. x 100'	1
U890W100			1-1/2 in. x 100'	1
U895W100			2 in. x 100'	1

## PEX Pipe (straight lengths)



Part number White	Part number Red	Part number Blue	Size	Qty
U850W5			1/4 in. (3/8 in. OD) x 5'	20
U855W5			3/8 in. x 5'	10
U855W10			3/8 in. x 10'	10
U860W2	U860R2	U860B2	1/2 in. x 2'	60
U860W5	U860R5	U860B5	1/2 in. x 5'	10
U860W10	U860R10	U860B10	1/2 in. x 10'	10
U860W20	U860R20	U860B20	1/2 in. x 20'	10
U870W2	U870R2	U870B2	3/4 in. x 2'	30
U870W5	U870R5	U870B5	3/4 in. x 5'	10
U870W10	U870R10	U870B10	3/4 in. x 10'	10
U870W20	U870R20	U870B20	3/4 in. x 20'	10
U880W5	U880R5	U880B5	1 in. x 5'	5
U880W10	U880R10	U880B10	1 in. x 10'	5
U880W20	U880R20	U880B20	1 in. x 20'	5
U885W20			1-1/4 in. x 20'	5
U890W20			1-1/2 in. x 20'	5
U895W20			2 in. x 20'	3

## Reclaimed Water PEX Pipe

### Reclaimed Water PEX Pipe (purple coils)



For use with non-potable water applications and shall not be installed in UV-exposed environments

SharkBite reclaimed water PEX is cross-linked polyethylene pipe for gray water, rainwater harvesting and reclaimed water systems only. Manufactured with a purple color background, the pipe meets color code requirements of national and state code bodies to clearly identify reclaimed water lines. SharkBite reclaimed water PEX is manufactured and available in 1/2 in. to 1 in..

Part number	Size	Qty
U860P100	1/2 in. x 100'	1
U860P300	1/2 in. x 300'	1
U870P100	3/4 in. x 100'	1
U870P300	3/4 in. x 300'	1
U880P100	1 in. x 100'	1
U880P300	1 in. x 300'	1

## Oxygen Barrier PEX Pipe

### Oxygen Barrier PEX Pipe (orange coils)

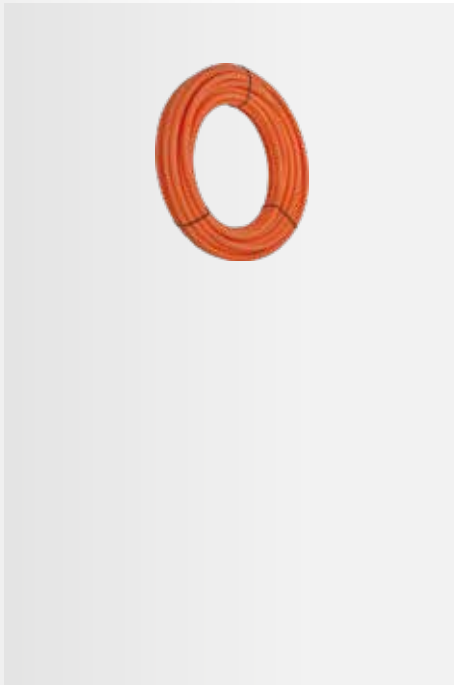

Use for radiant floor and hydronic heating applications. The oxygen diffusion barrier is applied to the exterior and limits oxygen permeation through the pipe wall in hydronic heating applications. This prevents corrosion of ferrous metal parts in the heating system.

Part number	Size	Qty
U855O100	3/8 in. x 100'	1
U855O300	3/8 in. x 300'	1
U855O500	3/8 in. x 500'	1
U860O100	1/2 in. x 100'	1
U860O300	1/2 in. x 300'	1
U860O500	1/2 in. x 500'	1
U860O1000	1/2 in. x 1000'	1
U865O300	5/8 in. x 300'	1
U870O100	3/4 in. x 100'	1
U870O300	3/4 in. x 300'	1
U870O500	3/4 in. x 500'	1
U870O1000	3/4 in. x 1000'	1
U880O100	1 in. x 100'	1
U880O300	1 in. x 300'	1
U880O500	1 in. x 500'	1

### Oxygen Barrier PEX Pipe (straight lengths)



Part number	Size	Qty
U860O20	1/2 in. x 20'	10
U870O20	3/4 in. x 20'	10
U880O20	1 in. x 20'	5
U880O20	1 in. x 20'	5





# Fast. Efficient. Reliable.

No special tools needed, resulting in faster installs and fewer install errors. Fewer callbacks, more jobs done and more satisfied customers. See how SharkBite can improve the efficiency of your next job.

Learn more at [sharkbite.com](http://sharkbite.com)

# Limited Warranty

## SharkBite, Cash Acme, and HoldRite Products

### WHAT DOES THIS WARRANTY COVER?

Subject to conditions outlined in this statement, RWC (in the USA, Reliance Worldwide Corporation and in Canada, Reliance Worldwide Corporation (Canada) Inc.) warrants to owners of real property in the United States and Canada that SharkBite and Cash Acme products, when used and installed in accordance with the requirements set forth, shall be free from defects in material and workmanship for the applicable Warranty Period. This Limited Warranty is in effect for installations made after January 1, 2018 and is applicable to products installed in the country in which they were purchased.

Proof of purchase is required to validate the Warranty Period. If proof of purchase is not available, the Warranty Period commencement shall default to the date of manufacture for each product. If the product suspected of a defect does not have a clear date of manufacture on it, a proof of purchase will be required.

### WHAT ARE THE CONDITIONS OF THIS WARRANTY?

1. All products must be installed in accordance with all then applicable codes, good plumbing practice, in accordance with any local, state, provincial or federal requirements, and installed in a potable water or radiant heating application unless a non-potable water service is specifically allowed for in the pertinent product literature.
2. The installer must use construction techniques compliant with then applicable codes to install the product and use the product within the design parameters specified in any installation guidelines and technical notes for the applicable system. This shall include field pressure testing prior to concealing with concrete or by other means and wrapping any brass fitting when buried. Failure to install RWC products according to manufacturer's installation instruction will void all applicable warranties and may result in severe water damage.
3. Products must at all times be used in a manner consistent with their intended use and be used in installations and environments acceptable to their material and design specifications, including not being installed in a system that may operate at temperatures or at pressures that exceed the approved ratings which can be found on the product, packaging or installation instructions.
4. Additional product specific conditions of this Limited Warranty and the Warranty Period are documented in the section entitled, **How long does the limited warranty coverage last and what other specific conditions exist for each product?**
5. Without limiting the foregoing, this Limited Warranty does not apply and you do not have a right of reimbursement if the product failure or resulting damage is caused by: (a) evidence of tampering, mishandling, neglect, abuse, accidental damage, freeze damage (it is expressly understood that failure as a result of any freezing fluids within the pipes does not constitute a defect in material or workmanship and shall not be covered by this warranty) or unauthorized modifications or repairs that cause

damage to warranted products; (b) exposure to harmful, unauthorized, or unanticipated chemicals or substances or corrosive water conditions; (c) exposure to ultraviolet light; (d) faulty installation including failure to follow proper burial instructions; (e) damage from abnormal operating conditions including exposure pressures and temperatures beyond the specified operating range; (f) failure to properly test and pass common testing methods (including pressure testing) after the installation and before the product or system is put in service; (g) components not manufactured or sold by RWC; or (h) acts of nature such as earthquakes, fire, flood or lightning.

6. Although RWC provides a plumbing system to facilitate a complete installation, other manufacturers pipe and/or fittings may be installed in any given installation provided manufacturing of the pipe and/or fittings demonstrates compliance with the applicable ASTM/CSA standards, and the product has been certified by a recognized third-party testing agency. The RWC product in the given installation will continue to be covered under this Limited Warranty although limits on Warranty Period may apply. RWC will be responsible only for proven defects in material or workmanship in RWC products. Problems in products manufactured by another company should be reported to that manufacturer.

### HOW DO YOU GET SERVICE?

In order to be eligible for service under this Limited Warranty you must return the defective product to RWC for inspection and testing within thirty (30) days after detection of alleged failure or defect occurring within applicable Warranty Period (with shipping charges prepaid) to the original place of purchase. If the alleged defect involves a connection or joint with a RWC product, the fitting must be returned with a section of the pipe still inserted. You must include the model number of the product (if available), the original date of purchase, proof of purchase and the nature of the alleged product failure or defect. Products returned without shipping charges prepaid will be refused. For questions or inquiries, in the U.S. call 1(877)700-4242 and in Canada 1(888)820-0120.

### WHAT WILL RWC DO?

If, after inspection, we find that a product covered by this Limited Warranty has failed due to a defect in material or workmanship during the specified Warranty Period, we will repair or replace, at our sole option, free of charge, the defective product during normal working hours and through a place of business as determined by RWC.

Notwithstanding anything to the contrary in this Limited Warranty, if RWC determines that any damages to the real property in which a defective product was installed were the direct result of a leak or failure caused by a defect in material or workmanship in any RWC product covered by this Limited Warranty and occurring within the first ten years after date of purchase or during the applicable Warranty Period, whichever is shorter, and if reasonable steps were taken to promptly limit or stop the effects of such leak or failure as soon as it was discovered, then RWC will reimburse the property owner for the reasonable costs of repairing

or replacing such damaged real property to include flooring, drywall and painting and other real property damaged by the leak directly caused by the allegedly defective RWC product when the RWC SharkBite Connection System product was installed by a licensed professional plumbing contractor. Except as specified above or otherwise specifically authorized in writing by RWC, RWC shall not pay for any costs or expenses for transportation, relocation, labor, repairs or any other work associated with removing and/or returning failed or defective products or installing replacement products.

This shall constitute the sole and exclusive remedy for any defective product.

### WHAT DOES THIS LIMITED WARRANTY NOT COVER?

RWC shall not be responsible for any other incidental, indirect, contingent, special or consequential damages, including without limitation, economic loss, lost profits or the cost of repairing or replacing other property which is damaged if these warranted products do not work properly, other costs resulting from labor charges, delays, vandalism, negligence, fouling caused by foreign material, damage from adverse water conditions, adverse chemical environments, or any other circumstances over which RWC has no control. This limitation applies even if RWC could have foreseen or has been advised of the possibility of these damages. This Limited Warranty shall be invalidated by any abuse, misuse, misapplication or improper installation of the product. Any remaining warranty coverage may not be assigned or transferred after the period ending ten years following the installation. RWC does not guarantee or in any way warrant the integrity or workmanship of the contractor/installer.

### MISCELLANEOUS

Some States/Provinces do not allow limitations on how long an implied warranty lasts, and some States/Provinces do not allow the exclusion or limitation of incidental or consequential damages. Therefore, the above limitations may not apply to you. This Limited Warranty gives you specific legal rights, and you may have other rights that vary from State/Province to State/Province. You should consult applicable State/Provincial laws to determine your rights.

**So far as is consistent with applicable state/provincial/federal law, the express warranty set forth herein is the only warranty given by rwc with respect to the SharkBite® and CashAcme® products and RWC makes no other warranties, expressed or implied, and hereby specifically disclaims all other warranties, expressed or implied, including but not limited to the implied warranties of merchantability and fitness for a particular purpose.**

This Limited Warranty and any claims arising from breach of contract, breach of warranty, tort, or any other claim arising from sale or use of RWC's products shall be governed and construed under the laws of the State of Georgia. No action on the part of RWC under this Limited Warranty shall be construed as an admission of liability of that the product is not fit for its intended use.

## How long does the limited warranty coverage last and what other specific conditions exist for each product?

Classification	Product Category	Limited Warranty Period	Conditions
SharkBite Connection Systems	SharkBite Brass and Poly PEX Barb Fittings in conjunction with SharkBite PEX Pipe and SharkBite Rings/Clamps	Twenty-Five (25) Years	Must be used with <ul style="list-style-type: none"> <li>SharkBite PEX Pipe - ASTM F876/CSAB137.5</li> <li>SharkBite Copper Crimp Rings – ASTM F1807 or F2159</li> <li>SharkBite Stainless Steel Clamp Rings – ASTM</li> </ul>
	SharkBite EvoPEX Fittings in conjunction with SharkBite PEX Pipe	Twenty-Five (25) Years	Must be used with: <ul style="list-style-type: none"> <li>SharkBite PEX Pipe - ASTM F876/CSAB137.5</li> </ul>
	SharkBite Universal Push-To-Connect Fittings in conjunction with SharkBite PEX Pipe	Twenty-Five (25) Years	Must be used with: <ul style="list-style-type: none"> <li>SharkBite PEX Pipe - ASTM F876/CSA B137.5</li> </ul>
SharkBite, Cash Acme, HoldRite, and John Guest Products	SharkBite Universal Push-To-Connect Fittings and SharkBite Large Diameter Push-To-Connect Fittings in Application with Copper, PEX, CPVC and/or PE-RT	Twenty-Five (25) Years	Must be used with: <ul style="list-style-type: none"> <li>Copper—ASTM B 88 hard drawn copper tube K, L, and M</li> <li>PEX—ASTM F876/CSA B137.5</li> <li>CPVC—ASTM D2846 or CSA B137.6</li> </ul>
	SharkBite Universal Push-To-Connect Fittings and SharkBite Large Diameter Push-To-Connect Fittings in	Five (5) Years	Must be used with: <ul style="list-style-type: none"> <li>HDPE SDR-9 ASTM D2737</li> </ul>
	SharkBite Accessories (Ball Valves, Supply Hoses, Supply Stops, Supply Valve Box Systems, Kits, Copper Manifolds, etc.)	Two (2) Years	Must be installed per installation instructions with the pipes below: <ul style="list-style-type: none"> <li>Copper—ASTM B 88 hard drawn copper tube K, L, and M</li> <li>PEX—ASTM F876/CSA B137.5</li> <li>CPVC—ASTM D2846 or CSA B137.6</li> <li>PE-RT—ASTM F2769</li> </ul>
	SharkBite ProLock	Twenty-Five (25) Years	Must be used with: <ul style="list-style-type: none"> <li>SharkBite PEX – ASTM F876/CSAB137.5</li> <li>SharkBite PE-RT – ASTM F2769</li> </ul>
	SharkBite Poly PEX Barb Fittings	Five (5) Years	When used with Non-SharkBite PEX Pipe that conform to ASTM F876 CSA B137.5, PE-RT that conform ASTM F2769, and Clamp/Rings ASTM F2159
	SharkBite Brass PEX Barb Fittings/ Copper Manifold	Five (5) Years	When used with Non-SharkBite PEX Pipe that conform to ASTM F876/CSA B137.5, that conform ASTM F2769 and Clamp/Rings – ASTM F1807
	SharkBite EvoPEX Fittings	Five (5) Years	When used on Non-SharkBite PEX Pipe that conform to: <ul style="list-style-type: none"> <li>ASTM F876/CSA B137.5</li> </ul>
	SharkBite PEX Pipe	Twenty-Five (25) Years	When used with Fitting and Clamps/Rings that conform to: <ul style="list-style-type: none"> <li>ASSE 1061, ASTM F1807, ASTM F2098, and/or ASTM F2159 Fittings</li> </ul>
	SharkBite PE-RT Pipe	Twenty-Five (25) Years	When used with Fitting and Clamps/Rings that conform to: <ul style="list-style-type: none"> <li>ASSE 1061, ASTM F1807, ASTM F2098, and/or ASTM F2159 Fittings</li> </ul>
	SharkBite Home Run Manifolds	Ten (10) Years	Must be installed per installation instructions
	SharkBite Tools	One (1) Year	From date of purchase
	SharkBite and Cash Acme Thermostatic Mixing Valves	Five (5) Years	Must be installed per installation instructions
	Other SharkBite and Cash Acme Valves	Two (2) Years	Must be installed per installation instructions
	John Guest Black Click-to-Lock CTS Fittings	Twenty-Five (25) Years	Must be used with: <ul style="list-style-type: none"> <li>Copper—ASTM B 88 hard drawn copper tube K, L, and M</li> <li>PEX—ASTM F876/CSA B137.5</li> <li>CPVC—ASTM D2846 or CSA B137.6</li> </ul>
	John Guest Speedfit Twist & Lock CTS Fittings	Twenty-Five (25) Years	Must be used with: <ul style="list-style-type: none"> <li>Copper—ASTM B 88 hard drawn copper tube K, L, and M</li> <li>PEX—ASTM F876/CSA B137.5</li> </ul>
	John Guest Fluid System OD Fittings	One (1) Years	Must be used with Polyethylene, Nylon, PEX, or Soft Copper (must be round and in good condition)
	SharkBite Quick-Connect POM Plastic Fittings	One (1) Years	Must be used with Polyethylene, Nylon, PEX, or Soft Copper (must be round and in good condition)
	HoldRite Products	One (1) Years	Must be installed per installation instructions
	HoldRite QuickBrand Products	One (1) Years	Must be installed per installation instructions
	HoldRite Testrite	One (1) Years	Must be installed per installation instructions
HoldRite HydroFlame Pro	Two (2) Years	Must be installed per installation instructions	





Part Number	Page	Part Number	Page	Part Number	Page	Part Number	Page	Part Number	Page	Part Number	Page
22182-0000LF	32	23102CP100	55	24633LF	33	25561	26	K24650WP	42	U272LF	14
22185-0000LF	32	23103	55	24634LF	33	25562	26	K25721WP	42	U273	17
22186-0000LF	32	23103CP25	55	24635LF	33	25567	26	K25722WP	42	U274LF	14
22187-0000LF	32	23103CP100	55	24636LF	34	25568	26	K25723WP	42	U276LF	14
22222-0000LF	32	23104	55	24637LF	34	25704LF	37	K25811	43	U278LF	14
22223-0000LF	32	23104CP25	55	24638LF	34	25743LF	34	K25813	43	U280LF	14
22304-0000LF	32	23220	55	24656	22	25744LF	34	K25815	43	U281LF	14
22305-0000LF	32	23220Z100	55	24657	22	25757	33	K25817	43	U286LF	14
22306-0000LF	32	23221	55	24675	57	25758	34	K23036	43	U308LF	14
22441LF	25	23251	57	24680	20	25759	34	K23037	43	U314LF	14
22461LF	53	23336-0000LF	20	24686	23	25773	34	K22222	43	U332LF	14
22462LF	53	23337-0000LF	21	24687	23	25774	34	K22185	43	U334LF	14
22463LF	53	23358-0045	35	24731LF	20	25751	34	K22223	43	U335LF	14
22486LF	25	23369	57	24732LF	21	25752	34	PM012SB	24	U340LF	14
22604LF	25	23382LF	52	24733LF	20	25753	34	PM012UP	53	U351LFA	24
22630LF	24	23383	57	24734LF	21	25754	34	PM024SB	24	U358LF	15
22631LF	24	23489	10	24735LF	32	25755	34	PM024UP	53	U359LF	15
22632LF	24	23807-0045	35	24736LF	32	25828	14	RM22712	53	U360LF	15
22633LF	24	23808-0045	35	24813A	54	25847-0045	35	RM22724	53	U362LF	15
22675-0045	35	23893-0045	35	24867	36	25848-0045	35	SBDC354154	13	U363LF	15
22783	53	23894-0045	35	24867	36	25849-0045	35	SBDS123838Z	21	U364LF	15
22784	53	23896-0060	35	24930	23	25846-0045	35	SBDS123814Z	21	U366	17
22785	53	23945-0060	35	24931	23	BF5M1401SB	36	SBTL35	29	U370LF	15
22786	53	23955-0045	35	24932	23	BF10101SB	36	SBTL41	29	U374LF	15
22787	53	23956-0045	35	24933	23	BF13434SB	36	SBTL54	29	U380LF	16
22788	53	24377	33	24934	23	BF5M0134SB	36	SS3068FLEX18BV	20	U412LF	6
22789	53	24383-0045	35	24935	23	BF5M1401SB	36	SS3086FLEX24LF	19	U416LF	15
22790	53	24384-0045	35	24936	23	K008WP3	40	SS3088FLEX18BV	20	U4248LF	18
22791	53	24436	24	24937	23	K016WP3	40	SS3088FLEX12LF	19	U4256LF	18
22973LF	32	24437	24	24938	23	K020WP2	40	SS3088FLEX18LF	9	U444LF	15
22993LF	32	24438	24	24939	23	K058WP3	40	SS3088FLEX18LF	19	U4482LF	16
23036LFBNZ	21	24438A	24	24940	23	K060WP2	40	SS3088FLEX24LF	19	U454LF	15
23036-0000LF	20	24439	24	24946	20	K072WP3	40	SS3094FLEX24LF	19	U462LF	16
23037-0000LF	21	24440	24	24947	21	K088WP3	40	SS3096FLEX24LF	19	U464LF	16
23048-0000LF	20	24441	24	24963	23	K094WP2	40	U004LF	11	U512LF	17
23049-0000LF	21	24442	24	24983	21	K120WP3	40	U006LF	11	U514LF	17
23050	55	24443	24	24984	21	K134WP3	40	U008LF	11	U516	17
23051	55	24444	24	24985	21	K140WP2	40	U009LF	11	U518LF	17
23053	55	24445	24	24986	21	K248WP6	40	U012	17	U520LF	17
23054	55	24449-0045	35	24987	21	K256WP6	40	U016LF	11	U5248LF	13
23055	57	24476-0045	35	24998A	54	K260WP2	40	U020LF	11	U5260LF	13
23056LF	52	24477-0045	35	25024	26	K274WP3	40	U050LF	11	U615LF	13
23057LF	52	24504	35	25087	25	K277WP2	40	U057	17	U620LF	13
23058LF	52	24505	25	25088	25	K280WP2	41	U058LF	11	U648LF	13
23059LF	52	24529	36	25094	53	K308WP2	41	U060LF	11	U656LF	13
23060LF	52	24530	36	25096	26	K334WP3	41	U066LF	12	U660LF	13
23061LF	52	25739	54	25097	26	K340WP2	41	U068LF	12	U701	57
23062LF	52	25740	54	25098	26	K362WP3	41	U070LF	12	U702	28
23063LF	52	24548	35	25099	26	K370WP3	41	U072LF	12	U706	28
23064LF	52	24549	35	25374	25	K374WP2	41	U086LF	17	U708	28
23065	55	25756	34	25401	53	K4483WP3	41	U088LF	12	U710	28
23066LF	52	25759	34	25406	29	K4485WP2	41	U092LF	12	U711	28
23067LF	49	25880	57	25464	54	K408WP3	42	U094LF	12	U712	28
23068LF	49	24609-0150	37	25478	54	K412WP3	42	U110LF	12	U713	28
23069	53	24612LF	54	25484Z	53	K413WP2	42	U116LF	12	U714	28
23070	53	24613LF	54	25485Z25	55	K414WP2	42	U118LF	12	U715	28
23071A10	55	24615-0000LF	32	25486Z25	55	K415WP2	42	U120LF	12	U719LF	17
23072A10	55	24616-0000LF	32	25490Z	55	K416WP2	42	U126	17	U721LF	17
23073A10	55	24617-0000LF	32	25521Z	35	K418WP2	42	U134LF	12	U722LF	17
23074A10	55	24620LF	33	25538	25	K419WP2	42	U138LF	12	U724LF	17
23075A10	55	24621LF	33	25539	25	K444WP3	42	U139LF	12	U766LF	12
23076A10	55	24622LF	34	25550LF	33	K454WP3	42	U140LF	12	U772LF	12
23080	57	24623LF	34	25551LF	33	K514WP6	42	U142LF	12	U782LF	22
23081	57	24626LF	33	25552LF	23	K518WP6	42	U244LF	13	U850W5	60
23100	57	24627LF	33	25553LF	23	K520WP2	42	U246LF	13	U850W50	60
23101	55	24628LF	34	25554LF	23	K25578WP12	42	U248LF	13	U850W100	60
23101CP25	55	24629LF	34	25555LF	23	K25581WP12	42	U249LF	14	U855B100	60
23101CP100	55	24630LF	34	25558LF	21	K25721WP12	42	U252	17	U855O100	61
23102	55	24631LF	33	25559LF	27	K25722WP12	42	U256LF	13	U855O300	61
23102CP25	55	24632LF	33	25560LF	27	K24649WP	42	U260LF	13	U855O500	61

Part Number	Page	Part Number	Page	Part Number	Page	Part Number	Page	Part Number	Page	Part Number	Page
U855R100	60	U870W10	60	U3531LF	22	UC444LF	48	UIP520	19	UXL0941	13
U855W5	60	U870W20	60	U3537LF	22	UC452LF	48	UIP710	19	UXL0954	13
U855W10	60	U870W25	60	U3712	28	UC0454	49	UIP712	19	UXL013528	11
U855W50	60	U870W50	60	U4008LF	18	UC454LF	48	UIP714	19	UXL014128	11
U855W100	60	U870W100	60	U4016LF	18	UC512LF	49	UIP3008	18	UXL014135	11
U860B2	60	U870W300	60	U4358LF	22	UC514LF	49	UIP3016	18	UXL015441	11
U860B5	60	U870W500	60	UC006LF	46	UC518LF	49	UIP3020	18	UXL113532F	12
U860B10	60	U880B5	60	UC008LF	46	UC520LF	49	UIP4008	18	UXL113532M	12
U860B20	60	U880B10	60	UC009LF	46	UC526LF	49	UIP4016	18	UXL114140F	12
U860B25	60	U880B20	60	UC012LF	46	UC527LF	49	UIP4020	18	UXL114140M	12
U860B50	60	U880B100	60	UC016LF	46	UC528LF	49	UP008	50	UXL115450F	12
U860B100	60	U880B300	60	UC020LF	46	UC529LF	49	UP016	50	UXL115450M	12
U860B300	60	U880B500	60	UC057LF	46	UC530LF	49	UP020	50	UXL123516	17
U860B500	60	U880O20	61	UC058LF	46	UC531LF	49	UP058	50	UXL123522	17
U860B1000	100	U880O20	61	UC060LF	46	UC532LF	49	UP060	50	UXL123528	17
U860O20	61	U880O100	61	UC068LF	46	UC534LF	49	UP120	50	UXL124116	17
U860O100	61	U880O300	61	UC072LF	46	UC594LF	49	UPI34	50	UXL124122	17
U860O300	61	U880O500	61	UC088LF	46	UC600LF	47	UPI38	50	UXL124128	17
U860O500	61	U880P100	61	UC092LF	46	UC605LF	47	UPI40	50	UXL124135	17
U860O1000	61	U880P300	61	UC094LF	46	UC606LF	47	UP248	50	UXL125416	17
U860P100	61	U880R5	60	UC116LF	46	UC607LF	47	UP256	50	UXL125422	17
U860P300	61	U880R10	60	UC118LF	46	UC608LF	47	UP260	50	UXL125428	17
U860R2	60	U880R20	60	UC113532F	46	UC609LF	47	UP274	51	UXL125435	17
U860R5	60	U880R100	60	UC114140F	46	UC626LF	47	UP280	50	UXL125441	17
U860R10	60	U880R300	60	UC115450F	46	UC628LF	47	UP360	51	UXL08351635	15
U860R20	60	U880R500	60	UC113532M	46	UC0835	48	UP362	51	UXL08352216	15
U860R25	60	U880W5	60	UC114140M	46	UC0841	48	UP370	51	UXL08352222	15
U860R50	60	U880W10	60	UC115450M	46	UC0854	48	UP374	51	UXL08352228	15
U860R100	60	U880W20	60	UC120LF	46	UC952	55	UP408	51	UXL08352235	15
U860R300	60	U880W100	60	UC134LF	46	UC953	55	UP412	51	UXL08352816	15
U860R500	60	U880W300	60	UC0135	46	UC954	55	UP414	51	UXL08352822	15
U860R1000	60	U880W500	60	UC138LF	46	UC955	55	UP415	51	UXL08352828	15
U860W2	60	U885W20	60	UC139LF	46	UC956	55	UP416	51	UXL08353516	15
U860W5	60	U885W100	60	UC140LF	46	UC961	57	UP444	51	UXL08353522	15
U860W10	60	U890W20	60	UC0141	46	UC4006LF	50	UP454	51	UXL08353528	6
U860W20	60	U890W100	60	UC142LF	46	UC4008LF	50	UP514	51	UXL08412822	15
U860W25	60	U895W20	60	UC0154	46	UC4016LF	50	UP518	51	UXL08412828	15
U860W50	60	U895W100	60	UC0235	47	UC013522	46	UP520	51	UXL08412841	15
U860W100	26	U2008-0000LF	36	UC0241	47	UC013528	46	UP526	51	UXL08413522	15
U860W300	60	U2016-0000LF	36	UC246LF	47	UC014122	46	UP527	51	UXL08413528	15
U860W500	60	U2020-0000LF	36	UC248LF	47	UC014128	46	UP532	51	UXL08413535	15
U860W1000	60	U2276LF	14	UC0254	47	UC014135	46	UPMPT30	51	UXL08414116	15
U865O300	61	U3001A	25	UC256LF	47	UC014135	17	UPMPT3C	51	UXL08414122	15
U870B2	60	U3008FLEX18LF	20	UC260LF	47	UC015441	46	UPMPT40	52	UXL08414128	6
U870B5	60	U3008LF	11	UC272LF	47	UC0835	48	UPMPT4C	52	UXL08414135	6
U870B10	60	U3016FLEX18LF	20	UC273LF	47	UC08352828	48	UXL0135	11	UXL08543535	15
U870B20	60	U3016LF	11	UC274LF	47	UC08353516	48	UXL0141	11	UXL08544122	15
U870B25	60	U3020LF	11	UC278LF	47	UC08353522	48	UXL0154	11	UXL08544128	15
U870B50	60	U3068FLEX12LF	19	UC280LF	47	UC08353528	48	UXL0235	13	UXL08544135	15
U870B100	60	U3068FLEX15LF	19	UC286LF	47	UC08413528	48	UXL0241	13	UXL08544141	15
U870B300	60	U3068FLEX18BVLf	19	UC334LF	47	UC08414116	48	UXL0254	13	UXL08544154	15
U870B500	60	U3068FLEX18LF	19	UC340LF	47	UC08414122	48	UXL0335	16	UXL08545416	15
U870O20	61	U3068FLEX24LF	19	UC342LF	47	UC08414128	48	UXL0341	16	UXL08545422	15
U870O100	61	U3086FLEX24LF	20	UC360LF	48	UC08414135	48	UXL0354	16	UXL08545428	15
U870O300	61	U3088FLEX12LF	19	UC362LF	48	UC08545416	48	UXL0435	17	UXL08545435	15
U870O500	61	U3088FLEX15LF	19	UC363LF	48	UC08545422	48	UXL0441	17	UXL08545441	15
U870O1000	61	U3088FLEX18BVLf	19	UC364LF	48	UC08545428	48	UXL0454	17	UXLBV35	32
U870P100	61	U3088FLEX18LF	19	UC370LF	48	UC08545441	48	UXL0535	13	UXLBV41	32
U870P300	61	U3088FLEX24LF	19	UC374LF	48	UFH034	57	UXL0541	13	UXLBV54	32
U870R2	60	U3120LF	12	UC408LF	48	UIP120	18	UXL0554	13	UXLDC35	28
U870R5	60	U3134LF	12	UC412LF	18	UIP134	18	UXL0635	11	UXLDC41	28
U870R10	60	U3140LF	12	UC413LF	48	UIP140	18	UXL0641	11	UXLDC54	28
U870R20	60	U3358LF	22	UC414LF	48	UIP363	18	UXL0654	11	UXLG03	28
U870R25	60	U3362LF	16	UC415LF	48	UIP364	18	UXL0735	13	UXLG03	13
U870R50	60	U3370LF	16	UC416LF	48	UIP371	18	UXL0741	13		
U870R100	60	U3482LF	16	UC417LF	48	UIP372	18	UXL0754	13		
U870R300	60	U3486LF	16	UC418LF	48	UIP375	18	UXL0835	15		
U870R500	60	U3523LF	22	UC434LF	48	UIP376	18	UXL0841	15		
U870W2	60	U3524LF	22	UC0435	49	UIP514	19	UXL0854	15		
U870W5	60	U3525LF	22	UC0441	49	UIP518	19	UXL0935	13		



[rwc.com](http://rwc.com)

[sharkbite.com](http://sharkbite.com)

Manufactured and distributed by Reliance Worldwide Corporation

Certifications

The most up to date certifications can be found at [sharkbite.com/downloads](http://sharkbite.com/downloads).

2021-4

