



Nothing but **HEAVY DUTY.**

MILWAUKEE® HAND TOOLS AND STORAGE



**ULTIMATE PRODUCTIVITY.
SUPERIOR PERFORMANCE.**

STUD™ TAPE MEASURES

INDUSTRY'S MOST DURABLE TAPE MEASURE



*Functional After 80' Drop on Packed Soil

Model #	Description
48-22-9916	16ft STUD™ Tape Measure
48-22-9925	25ft STUD™ Tape Measure

AUTO-LOCK TAPE MEASURES

LONGEST LIFE

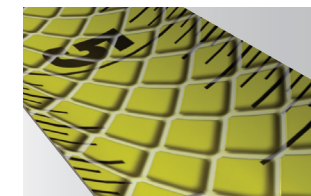

Nylon Bond Blade Protection

Model #	Description
48-22-6815	5m Tape Measure with Auto-Lock
48-22-6816	16ft Tape Measure with Auto-Lock
48-22-6817	5m/16ft Tape Measure with Auto-Lock
48-22-6818	8m Tape Measure with Auto-Lock
48-22-6825	25ft Tape Measure with Auto-Lock
48-22-6826	8m/16ft Tape Measure with Auto-Lock

MAGNETIC TAPE MEASURES

LONGEST LIFE



Magnet Holds EMT and Steel Studs

Model #	Description
48-22-7116	16ft Magnetic Tape Measure
48-22-7125	25ft Magnetic Tape Measure
48-22-7130	30ft Magnetic Tape Measure

Model #	Description
48-22-7135	35ft Magnetic Tape Measure
48-22-7216	5m / 16ft Magnetic Tape Measure
48-22-7225	8m / 26ft Magnetic Tape Measure

COMPACT TAPE MEASURES

LONGEST LIFE



Also Available:

Keychain Tape Measure
48-22-5506C

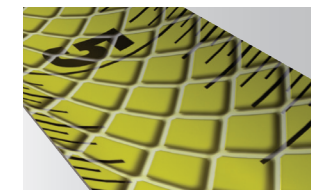

Nylon Bond Blade Protection

Model #	Description
48-22-5506	2m/6ft Keychain Tape Measure
48-22-6616	16ft Tape Measure
48-22-6625	25ft Tape Measure
48-22-6630	30ft Tape Measure
48-22-6612	12ft Tape Measure
48-22-6613	3m/12ft Tape Measure
48-22-6617	5m/16ft Tape Measure
48-22-6626	8m/26ft Tape Measure

OPEN REEL LONG TAPES

50% LESS STRETCH

3:1 Metal Planetary Gears
Prevents gear stripping & stress



Nylon Bond
Kink-Resistant Blade

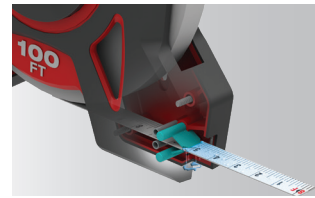

GRIME GUARD™
Industry's First Blade Wiper

Model #	Description
48-22-5201	100ft Open Reel Steel Long Tape with GRIME GUARD™ – 1/2" Blade
48-22-5230	300ft Open Reel Steel Long Tape with GRIME GUARD™ – 3/4" Blade

CLOSED REEL LONG TAPE

LONGEST LIFE

3:1 Torque Dispersing Planetary Gears
Prevents gear stripping & stress



Reinforced Metal Frame

Nylon Coated Blade

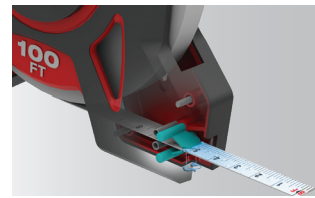

GRIME GUARD™
Industry's First Blade Wiper

Model #	Description
48-22-5101	100ft Closed Reel Long Tape with GRIME GUARD™ – 1/2" Blade

MEASURING WHEELS

**MOST DURABLE.
MOST ACCURATE.**

Top Reset Button
12" Model

Ergonomic Pistol Grip Design

Trigger Brake

Also Available:

Reinforced Folding Point & Aluminum Frame

Carrying Handle

Reinforced Folding Kickstand

Durable Wheel

6" Measuring Wheel
48-22-5006



Debris Cleaning Wheel Flap

Model #	Description	Model #	Description
48-22-5006	6" Measuring Wheel	48-22-5012	12" Measuring Wheel

REDSTICK™ BOX LEVELS

**MOST DURABLE.
GUARANTEED ACCURACY.**

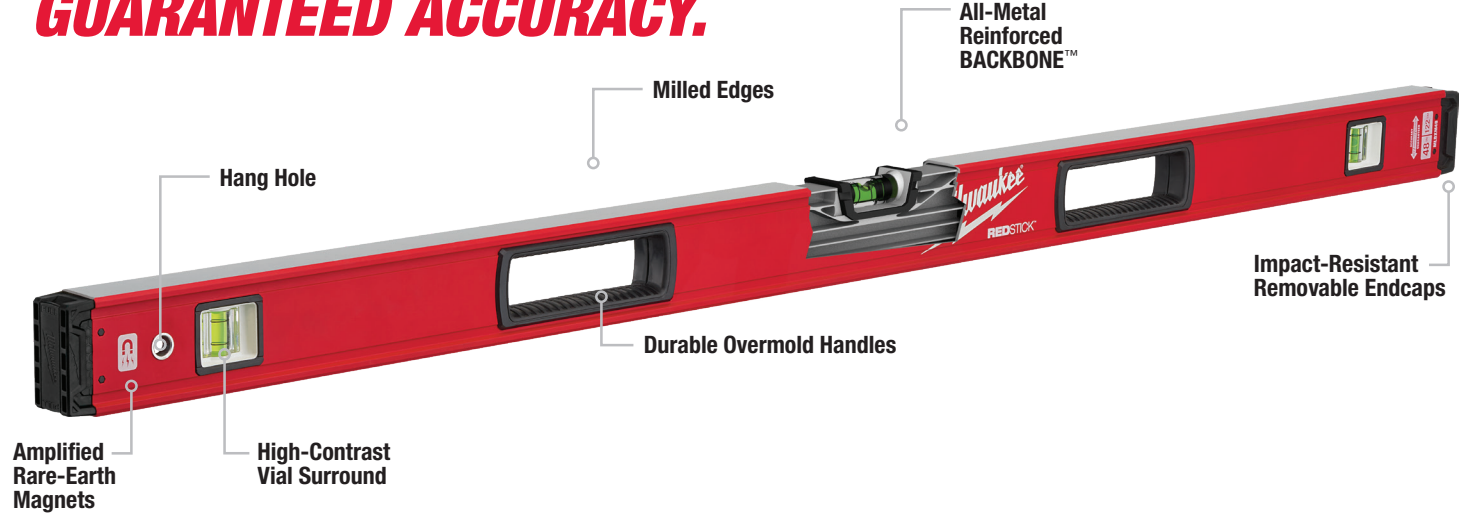

All-Metal Reinforced BACKBONE™

Milled Edges

Impact-Resistant Removable Endcaps

Durable Overmold Handles

Hang Hole

Amplified Rare-Earth Magnets

High-Contrast Vial Surround

Model #	Description
MLBX16	16" REDSTICK™ Box Level
MLBXM16	16" REDSTICK™ Magnetic Box Level
MLBX24	24" REDSTICK™ Box Level
MLBXM24	24" REDSTICK™ Magnetic Box Level
MLBX32	32" REDSTICK™ Box Level
MLBXM32	32" REDSTICK™ Magnetic Box Level
MLBX36	36" REDSTICK™ Box Level
MLBXM36	36" REDSTICK™ Magnetic Box Level
MLBX48	48" REDSTICK™ Box Level
MLBXM48	48" REDSTICK™ Magnetic Box Level
MLBX59	59" REDSTICK™ Box Level
MLBXM59	59" REDSTICK™ Magnetic Box Level
MLBX72	72" REDSTICK™ Box Level
MLBXM72	72" REDSTICK™ Magnetic Box Level

Model #	Description
MLBX78	78" REDSTICK™ Box Level
MLBXM78	78" REDSTICK™ Magnetic Box Level
MLBX96	96" REDSTICK™ Box Level
MLBXM96	96" REDSTICK™ Magnetic Box Level
MLBXS1648	16" / 48" REDSTICK™ Box Level Set
MLBXS48	24" / 48" REDSTICK™ Box Level Set
MLBXS48	24" / 48" REDSTICK™ Magnetic Box Level Set
MLBXJB	78" / 32" REDSTICK™ Magnetic Box Level Jamb Set
MLBXJBM	78" / 32" REDSTICK™ Magnetic Box Level Jamb Set
MLSB48	48" Level Bag
MLSB78	78" Level Bag
MLBXC48	4 Pc REDSTICK™ Starter Set
MLBXC78	5 Pc REDSTICK™ Master Set

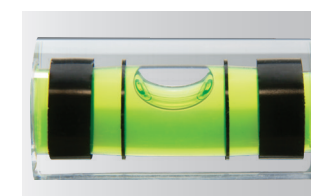

SHARPSITE™ Vial Technology

REDSTICK™ COMPACT BOX LEVELS

COMPACT DURABILITY

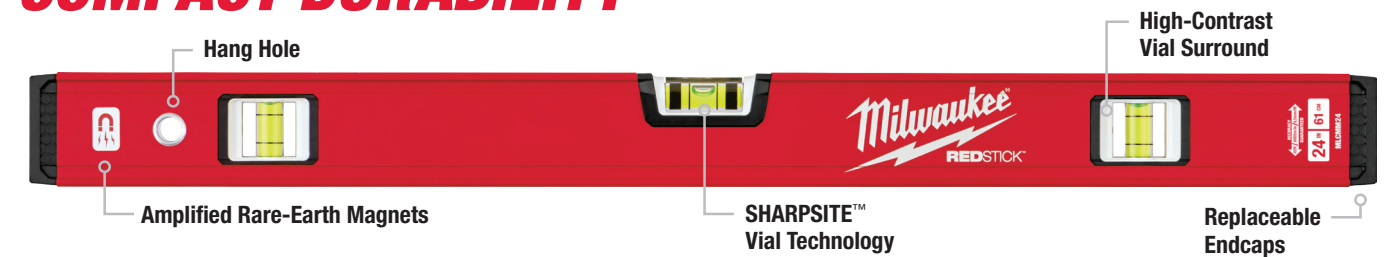

High-Contrast Vial Surround

Hang Hole

Amplified Rare-Earth Magnets

SHARPSITE™ Vial Technology

Replaceable Endcaps

Model #	Description
MLCM24	24" REDSTICK™ Compact Box Level
MLCMM24	24" REDSTICK™ Magnetic Compact Box Level
MLCM48	48" REDSTICK™ Compact Box Level
MLCMM48	48" REDSTICK™ Magnetic Compact Box Level

Model #	Description
MLCM72	72" REDSTICK™ Compact Box Level
MLCMM72	72" REDSTICK™ Magnetic Compact Box Level
MLCMS48	24" / 48" REDSTICK™ Compact Box Level Set
MLCMS48	24" / 48" REDSTICK™ Magnetic Compact Box Level Set

REDSTICK™ CONCRETE LEVELS

BUILT FOR CONCRETE



Screed

Smooth

Clean

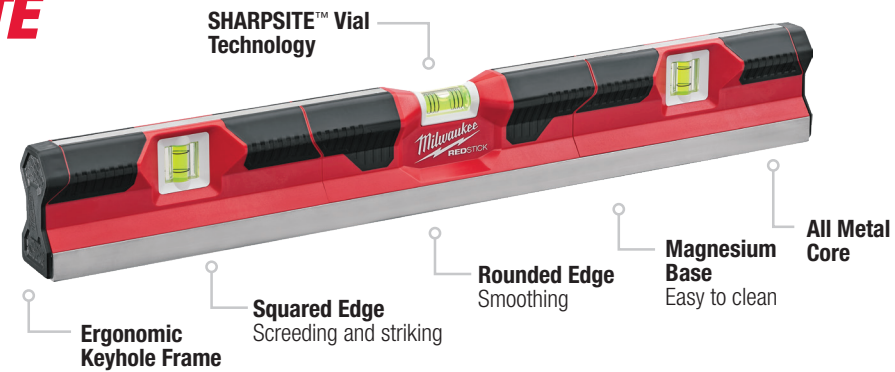

SHARPSITE™ Vial Technology

Ergonomic Keyhole Frame

Squared Edge
Screeding and striking

Rounded Edge
Smoothing

Magnesium Base
Easy to clean

All Metal Core

Model #	Description
MLCON24	24" REDSTICK™ Concrete Level
MLCON48	48" REDSTICK™ Concrete Level
MLCON72	72" REDSTICK™ Concrete Level

BILLET TORPEDO LEVELS

STRONGEST MAGNETS. EASIEST PITCH SET.

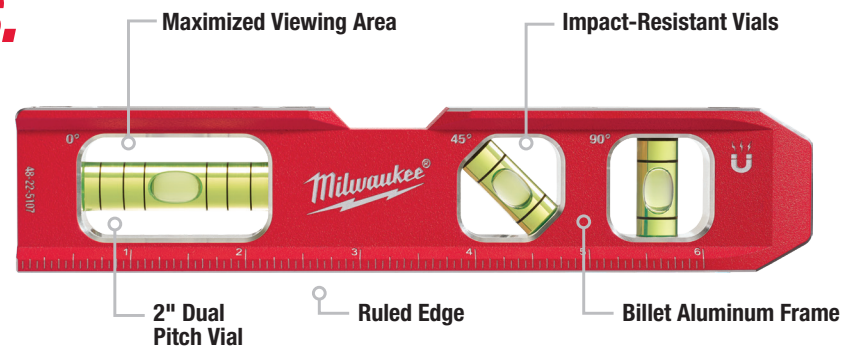

Maximized Viewing Area

Impact-Resistant Vials

2" Dual Pitch Vial

Ruled Edge

Billet Aluminum Frame



4 Amplified Rare-Earth Magnets

Model #	Description
48-22-5107	Billet Torpedo Level
48-22-5207	Metric Billet Torpedo Level

BLOCK TORPEDO LEVEL

STRONGEST MAGNETS. 360° ACCURACY.

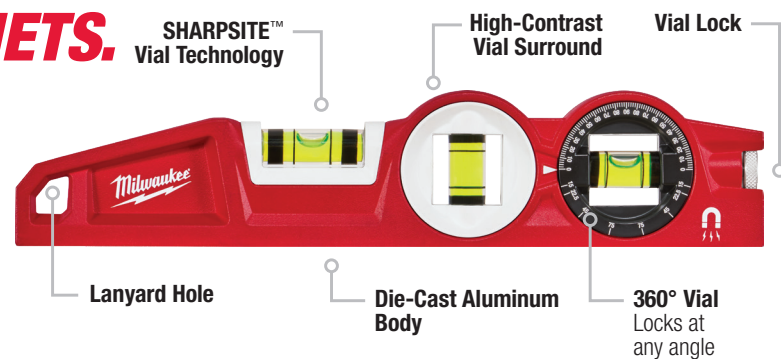

SHARPSITE™ Vial Technology

High-Contrast Vial Surround

Vial Lock

Lanyard Hole

Die-Cast Aluminum Body

360° Vial Locks at any angle

Also Available:



Pocket Level
48-22-5102

Model #	Description
48-22-5210	Block Torpedo Level
48-22-5102	Pocket Level



Amplified Rare-Earth Magnets

LASER DISTANCE METERS

EASIEST MEASUREMENTS



Simplified User Interface

2" Backlit Color Screen

Continuous Real-Time Measurements

2-Position Auto-Detecting Lever



Impact-Resistant Overmolding

Side-Shot Button
Allows for one-handed measurement in all situations

Also Available:



65ft Laser Distance Meter
48-22-9801

Model #	Description
48-22-9801	65ft Laser Distance Meter
48-22-9802	150ft Laser Distance Meter

Model #	Description
48-22-9803	330ft Laser Distance Meter

CHALK REELS

LONGEST GEAR LIFE. BEST PERFORMANCE.

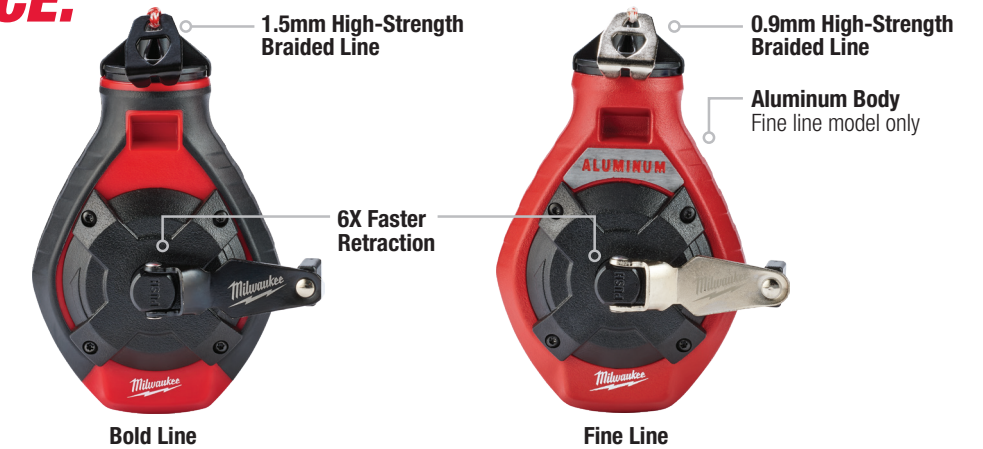

1.5mm High-Strength Braided Line

0.9mm High-Strength Braided Line

Aluminum Body
Fine line model only

6X Faster Retraction

Bold Line

Fine Line



StripGuard™ Clutch & Planetary Gears

Model #	Description
48-22-3980	Bold Line Chalk Reel
48-22-3982	Bold Line Chalk Reel & Blue Chalk Refill
48-22-3986	Bold Line Chalk Reel & Red Chalk Refill
48-22-3989	Bold Replacement Line

Model #	Description
48-22-3990	Fine Line Chalk Reel
48-22-3992	Fine Line Chalk Reel & Blue Chalk Refill
48-22-3993	Chalk Reel Kit with Blue Chalk Refill
48-22-3999	Fine Replacement Line

FOLDING RULES

MOST DURABLE MARKINGS & BLADES

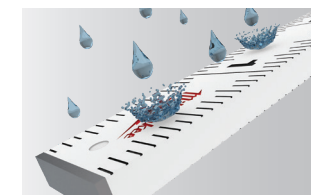

Water & Scratch Resistant Laminate

Quick Reference Bend Angles
22.5°, 30°, 45° & 60°

Heat-Stamped Markings
Won't wear

Corrosion-Free Embedded Joints
Locks at 0°, 90° & 180°



Model #	Description
48-22-3801	6-1/2ft Composite Folding Rule
48-22-3802	6-1/2ft Engineer's Composite Folding Rule

INKZALL™ JOBSITE MARKERS

**WRITES ON
DUST
WET
OILY
SURFACES**



Clog Resistant

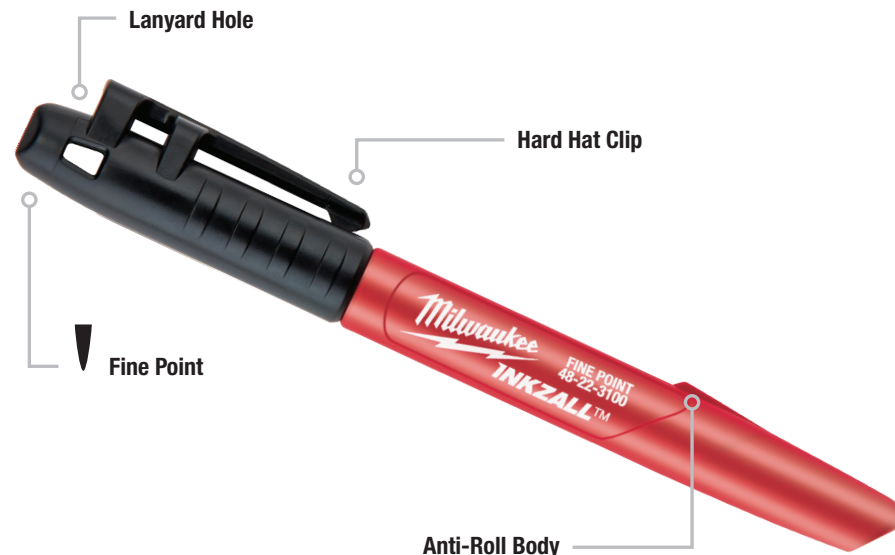

Model #	Description
48-22-3150	12 Pc INKZALL™ Ultra Fine Point Black Markers
48-22-3154	4 Pc INKZALL™ Ultra Fine Point Black Markers
48-22-3104	4 Pc INKZALL™ Fine Point Black Marker
48-22-3105	2 Pc INKZALL™ Fine Point Black Markers
48-22-3107	8 Pc INKZALL™ Fine Point Color Marker
48-22-3106	4 Pc INKZALL™ Fine Point Color Marker
48-22-3101	INKZALL™ Stylus and Fine Point Black Marker
48-22-3102	2 Pc INKZALL™ Medium Point Black Marker

Model #	Description
48-22-3103	INKZALL™ Chisel Tip Black Marker
48-22-3109	4 Pc INKZALL™ Chisel Tip Color Marker
48-22-3100	INKZALL™ Fine Point Black Markers (Bulk 36 Pc)
48-22-3130	INKZALL™ Chisel Tip Black Marker (Bulk 36 Pc)
48-22-3170	INKZALL™ Fine Point Red Markers (Bulk 36 Pc)
48-22-3180	INKZALL™ Fine Point Blue Markers (Bulk 36 Pc)
48-22-3190	INKZALL™ Fine Point Green Markers (Bulk 36 Pc)

INKZALL™ METALLIC MARKERS



Visible On Dark Surfaces



Model #	Description
48-22-3121	2 Pc INKZALL™ Fine Point Silver Metallic Marker
48-22-3122	2 Pc INKZALL™ Fine Point Gold Metallic Marker
48-22-3123	2 Pc INKZALL™ Fine Point Silver/Gold Metallic Marker

INKZALL™ LIQUID PAINT MARKERS

**BLEED &
SMEAR
RESISTANT**

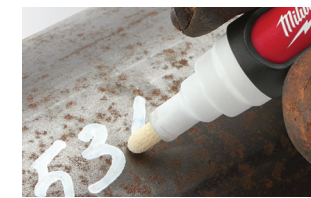

Marks on Surfaces up to 300°F

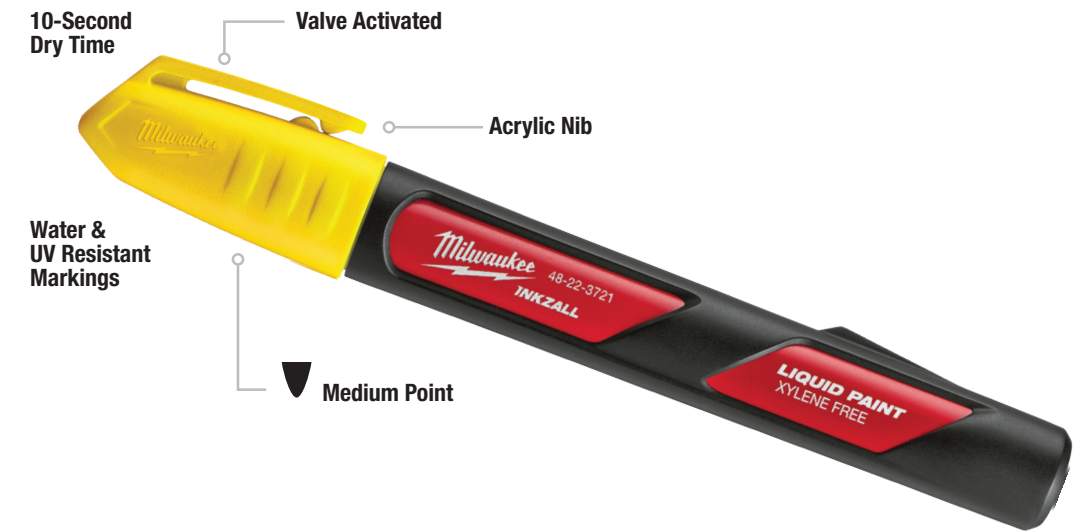

Model #	Description
48-22-3712	INKZALL™ Medium Point White Liquid Paint Marker
48-22-3722	INKZALL™ Medium Point Yellow Liquid Paint Marker
48-22-3711	INKZALL™ Medium Point White Liquid Paint Marker (Bulk 12 Pc)
48-22-3721	INKZALL™ Medium Point Yellow Liquid Paint Marker (Bulk 12 Pc)
48-22-3731	INKZALL™ Medium Point Black Liquid Paint Marker (Bulk 12 Pc)

Model #	Description
48-22-3741	INKZALL™ Medium Point Red Liquid Paint Marker (Bulk 12 Pc)
48-22-3751	INKZALL™ Medium Point Green Liquid Paint Marker (Bulk 12 Pc)
48-22-3761	INKZALL™ Medium Point Blue Liquid Paint Marker (Bulk 12 Pc)
48-22-3771	INKZALL™ Medium Point Orange Liquid Paint Marker (Bulk 12 Pc)

INKZALL™ JOBSITE PENS

**SHARP,
PRECISE
LINES**



Model #	Description
48-22-3160	12 Pc INKZALL™ Ultra Fine Point Black Pen
48-22-3161	12 Pc INKZALL™ Ultra Fine Point Red Pen
48-22-3162	12 Pc INKZALL™ Ultra Fine Point Blue Pen
48-22-3164	4 Pc INKZALL™ Ultra Fine Point Black Pen
48-22-3165	4 Pc INKZALL™ Ultra Fine Point Color Pen

INKZALL™ JOBSITE HIGHLIGHTERS

**UP TO
4X LONGER LIFE**



Model #	Description
48-22-3201	5 Pc INKZALL™ Chisel Tip Yellow Highlighter
48-22-3206	5 Pc INKZALL™ Chisel Tip Colored Highlighter

COMFORT GRIP STRAIGHT JAW PLIERS

REAM AND PUNCH™

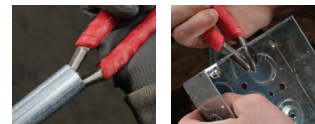

Ream Punch



Model #	Description	Jaw Capacity	Reaming Capacity
48-22-6306	6" Comfort Grip Straight Jaw Pliers	1"	3/4"
48-22-6310	10" Comfort Grip Straight Jaw Pliers	2"	2"
48-22-6312	12" Comfort Grip Straight Jaw Pliers	2-1/4"	2-3/4"
48-22-6316	16" Comfort Grip Straight Jaw Pliers	4-1/4"	3"
48-22-6320	20" Comfort Grip Straight Jaw Pliers	5-1/2"	3-1/2"
48-22-6330	2 Pc 6" & 10" Comfort Grip Straight Jaw Pliers Set	1" & 2"	3/4" & 2"
48-22-6331	3 Pc Comfort Grip Pliers Set	2"	2"

STRAIGHT JAW PLIERS

MAXIMUM GRIP. FORGED STRENGTH.



Reaming Head

Model #	Description	Jaw Capacity	Reaming Capacity
48-22-6510	10" Straight Jaw Pliers	2"	2"
48-22-6512	12" Straight Jaw Pliers	2-1/4"	2-3/4"

SMOOTH JAW PLIERS

SMOOTH JAW PROTECTS SURFACES



Non-Marring Smooth Jaw for Finish Applications



Model #	Description	Jaw Capacity	Reaming Capacity
48-22-6550	10" Smooth Jaw Pliers	2"	2"
48-22-6552	12" Smooth Jaw Pliers	2-1/4"	2-3/4"

V-JAW PLIERS



Ream Punch



Model #	Description	Jaw Capacity	Reaming Capacity
48-22-6208	8" Comfort Grip V-Jaw Pliers	1-1/2"	1-1/2"
48-22-6210	10" Comfort Grip V-Jaw Pliers	2"	2"
48-22-6212	12" Comfort Grip V-Jaw Pliers	2-3/4"	2-3/4"

LINEMAN'S PLIERS

MAXIMUM LEVERAGE. EASIER CUTS.*



Easily Cuts #2 ACSR
* When compared to other ACSR cutting lineman pliers



Model #	Description
48-22-6100	Comfort Grip High-Leverage Lineman's Pliers with Crimper
48-22-6500	High-Leverage Lineman's Pliers with Crimper
48-22-6502	High-Leverage Lineman's Pliers
48-22-6503	High-Leverage Lineman's Pliers with Thread Cleaner

ANGLED HEAD PLIERS

BETTER ACCESS



Angled Head



Model #	Description
48-22-6128	8" Comfort Grip Angled Head Diagonal Cutting Pliers
48-22-6528	8" Angled Head Diagonal Cutting Pliers

LONG NOSE PLIERS

LONG REACH



2" Gripping Nose



Also Available:
8" Long Nose Pliers
48-22-6501

Model #	Description
48-22-6101	8" Comfort Grip Long Nose Pliers
48-22-6501	8" Long Nose Pliers

DIAGONAL PLIERS

UP TO 2X MORE CUTS

IRON-CARBIDE EDGE



Tapered Nose



Also Available:
8" Diagonal Cutting Pliers
48-22-6508

Model #	Description
48-22-6106	6" Comfort Grip Diagonal Cutting Pliers
48-22-6107	7" Comfort Grip Diagonal Cutting Pliers
48-22-6108	8" Comfort Grip Diagonal Cutting Pliers
48-22-6508	8" Diagonal Cutting Pliers

6 IN 1 COMBINATION PLIERS

6IN1

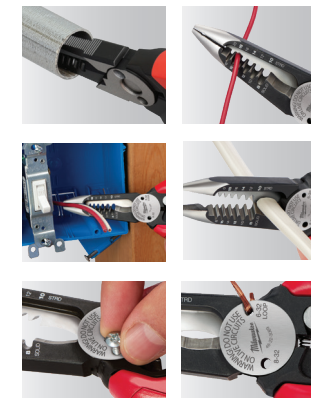
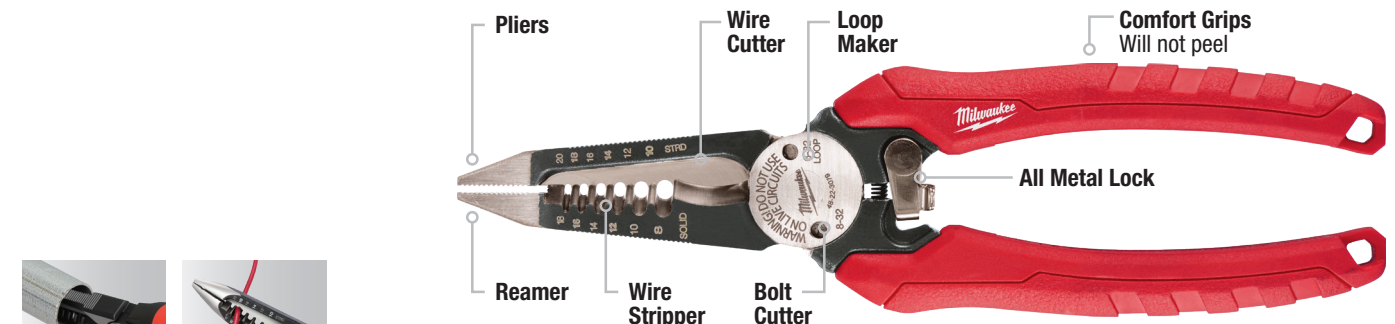

Model #	Description	Wire Stripper
48-22-3079	6in1 Comfort Grip Combination Pliers	8-18 AWG Solid, 10-20 AWG Stranded

MULTI-FUNCTION

FAST, ONE-HANDED OPERATION

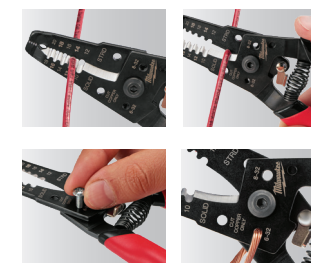
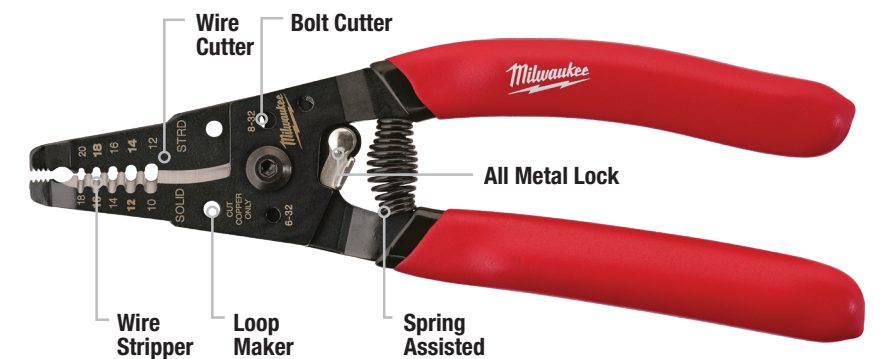

Model #	Description	Wire Stripper
48-22-6109	Wire Stripper	10-18 AWG Solid, 12-20 AWG Stranded
48-22-6579	Multi-Purpose Wire Stripper with Crimper	10-20 AWG Solid, 12-22 AWG Stranded

IRONWORKER'S

UP TO **2X MORE CUTS**

IRON-CARBIDE EDGE

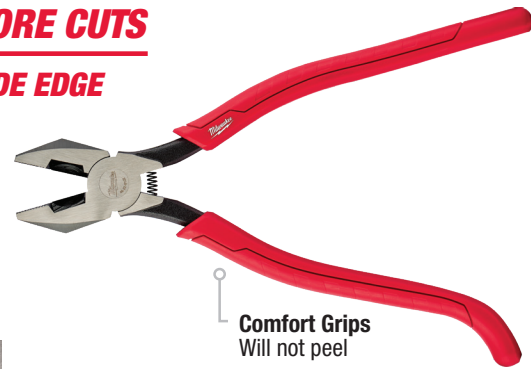

Comfort Grips
Will not peel



For Twisting & Cutting Rebar Ties

Model #	Description
48-22-6102	Ironworker's Pliers

CRIMPING

UP TO **2X CRIMPING FORCE**



Reaming Head
Wire Cutter

Comfort Grips
Will not peel

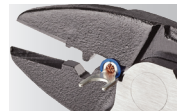

Crimper for Insulated & Non-Insulated Terminals

Model #	Description
48-22-6103	Crimping Pliers

CABLE CUTTING

CLEAN CUTS



Comfort Grips
Will not peel



Cuts up to 2/0 Cu, 4/0 Al

Model #	Description
48-22-6104	Cable Cutting Pliers

PVC / OIL FILTER

3-1/2" JAW CAPACITY



Comfort Grips
Will not peel



Model #	Description
48-22-6321	PVC / Oil Filter Pliers

NIPPING

CURVED HEAD PROTECTS SURFACES



Comfort Grips
Will not peel



Blades Will Not Mar Surfaces

Model #	Description
48-22-6407	7" Nipping Pliers

FENCING

FORGED STRENGTH



Staple Gripper
Wire Cutter
Wire Crimper
Hammer

Comfort Grips
Will not peel



Wire Puller

Model #	Description
48-22-6410	Fencing Pliers

**TORQUE LOCK™
FASTER SET-UP**

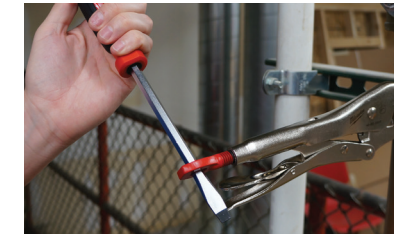

LOCKING PLIERS WITH MAX BITE™

**MAX BITE™
3X GRIPPING FORCE**



CHROME
Chrome plated rust protection



GRIPPED
Rubber overmold

Model #	Description
48-22-3607	7" Locking Pliers with MAX BITE™
48-22-3610	10" Locking Pliers with MAX BITE™
48-22-3702	2 Pc 7" & 10" Locking Pliers with MAX BITE™

Model #	Description
48-22-3710	10" Locking Pliers with Grip with MAX BITE™
48-22-3707	7" Locking Pliers with Grip with MAX BITE™

LOCKING PLIERS



CURVED JAW
Maximizes pressure points for any bolt, nut or locking tool application



STRAIGHT JAW
Maximizes contact points on jobsite work surfaces



LONG NOSE
Best for long reach applications

Model #	Description
48-22-3405	5" Curved Jaw Locking Pliers with Grip
48-22-3407	7" Curved Jaw Locking Pliers with Grip
48-22-3410	10" Curved Jaw Locking Pliers with Grip
48-22-3406	6" Long Nose Locking Pliers with Grip
48-22-3409	9" Long Nose Locking Pliers with Grip
48-22-3807	7" Straight Jaw Locking Pliers with Grip
48-22-3810	10" Straight Jaw Locking Pliers with Grip
48-22-3402	2 Pc 7" & 10" Curved Jaw Locking Pliers with Grip Set
48-22-3602	2 Pc 6" Long Nose & 10" Curved Jaw Locking Pliers Set
48-22-3423	4" Curved Jaw Locking Pliers
48-22-3422	5" Curved Jaw Locking Pliers
48-22-3421	7" Curved Jaw Locking Pliers

Model #	Description
48-22-3420	10" Curved Jaw Locking Pliers
48-22-3504	4" Long Nose Locking Pliers
48-22-3506	6" Long Nose Locking Pliers
48-22-3507	7" Straight Jaw Locking Pliers
48-22-3509	9" Long Nose Locking Pliers
48-22-3510	10" Straight Jaw Locking Pliers
48-22-3541	12" Large Jaw Locking Pliers
48-22-3523	9" Deep Reach Swivel Jaw Locking C-Clamp
48-22-3533	9" Deep Reach Locking C-Clamp
48-22-3631	11" Locking C-Clamp
48-22-3632	6" Locking C-Clamp

C-CLAMPS & SPECIALTY

STANDARD JAW C-CLAMP
Greater clamping versatility on a variety of shapes and surfaces



SWIVEL JAW C-CLAMP
Pads provide surface stabilization and protect work surfaces from damage



Model #	Description
48-22-3521	11" Swivel Jaw Locking C-Clamp
48-22-3522	6" Swivel Jaw Locking C-Clamp
48-22-3531	11" Locking C-Clamp
48-22-3532	6" Locking C-Clamp
48-22-3520	18" Swivel Jaw Locking C-Clamp

Model #	Description
48-22-3529	18" Deep Reach Locking C-Clamp
48-22-3530	18" Locking C-Clamp
48-22-3540	8" Locking Seamer
48-22-3542	9" Locking Chain Wrench
48-22-3543	9" Locking Welding Clamp

CHEATER ADAPTABLE PIPE WRENCH

3 LENGTH DESIGN



Model #	Description	Material	Max Jaw Capacity
48-22-7314	CHEATER Adaptable Pipe Wrench	Steel	2-1/2"

10L ALUMINUM PIPE WRENCH WITH POWERLENGTH™ HANDLE

BETTER ACCESS. MAXIMUM LEVERAGE.



Model #	Description	Material	Max Jaw Capacity
48-22-7313	10L Aluminum Pipe Wrench w/POWERLENGTH™ Handle	Aluminum	1-1/2"

STEEL & ALUMINUM PIPE WRENCHES

LARGEST GRIP SURFACE



Steel



Aluminum

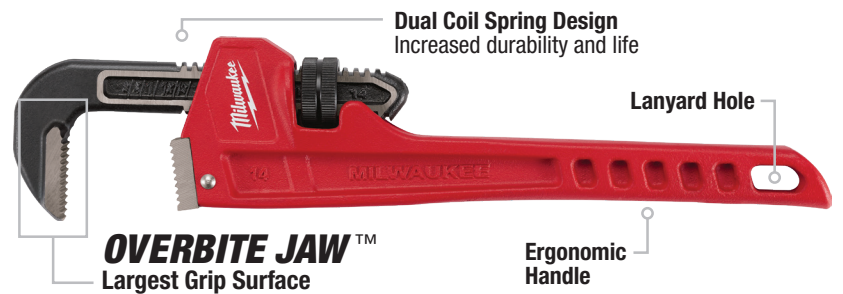

Model #	Description	Length	Material	Max Jaw Capacity	Model #	Description	Length	Material	Max Jaw Capacity
48-22-7106	6" Steel Pipe Wrench	6"	Steel	3/4"	48-22-7148	48" Steel Pipe Wrench	48"	Steel	6"
48-22-7108	8" Steel Pipe Wrench	8"	Steel	1"	48-22-7160	60" Steel Pipe Wrench	60"	Steel	8"
48-22-7110	10" Steel Pipe Wrench	10"	Steel	1-1/2"	48-22-7210	10" Aluminum Pipe Wrench	10"	Aluminum	1-1/2"
48-22-7112	12" Steel Pipe Wrench	12"	Steel	2"	48-22-7212	12" Aluminum Pipe Wrench	12"	Aluminum	2"
48-22-7114	14" Steel Pipe Wrench	14"	Steel	2"	48-22-7214	14" Aluminum Pipe Wrench	14"	Aluminum	2"
48-22-7118	18" Steel Pipe Wrench	18"	Steel	2-1/2"	48-22-7218	18" Aluminum Pipe Wrench	18"	Aluminum	2-1/2"
48-22-7124	24" Steel Pipe Wrench	24"	Steel	3"	48-22-7224	24" Aluminum Pipe Wrench	24"	Aluminum	3"
48-22-7136	36" Steel Pipe Wrench	36"	Steel	5"	48-22-7236	36" Aluminum Pipe Wrench	36"	Aluminum	5"
					48-22-7248	48" Aluminum Pipe Wrench	48"	Aluminum	6"

STEEL OFFSET HEX PIPE WRENCH

SMOOTH JAW WON'T MAR SURFACES

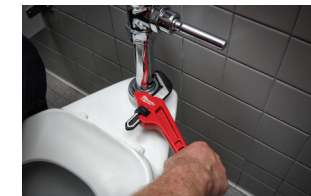

Protects Chrome Surfaces



Model #	Description	Material	Max Jaw Capacity
48-22-7171	Steel Offset Hex Pipe Wrench	Steel	2-5/8"

STEEL SMOOTH JAW PIPE WRENCH

SMOOTH JAW PROTECTS SURFACES



Protects Chrome Surfaces



Model #	Description	Material	Max Jaw Capacity
48-22-7186	12" Steel Smooth Jaw Pipe Wrench	Steel	2-5/8"

ALUMINUM OFFSET HEX PIPE WRENCHES

BETTER ACCESS

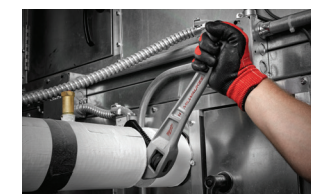

Offset Head



Model #	Description	Material	Max Jaw Capacity
48-22-7184	14" Aluminum Offset Pipe Wrench	Aluminum	2"
48-22-7185	18" Aluminum Offset Pipe Wrench	Aluminum	2"
48-22-7182	24" Aluminum Offset Pipe Wrench	Aluminum	3"

ADJUSTABLE WRENCHES

JAWS WON'T BACK OFF
Proprietary Screw

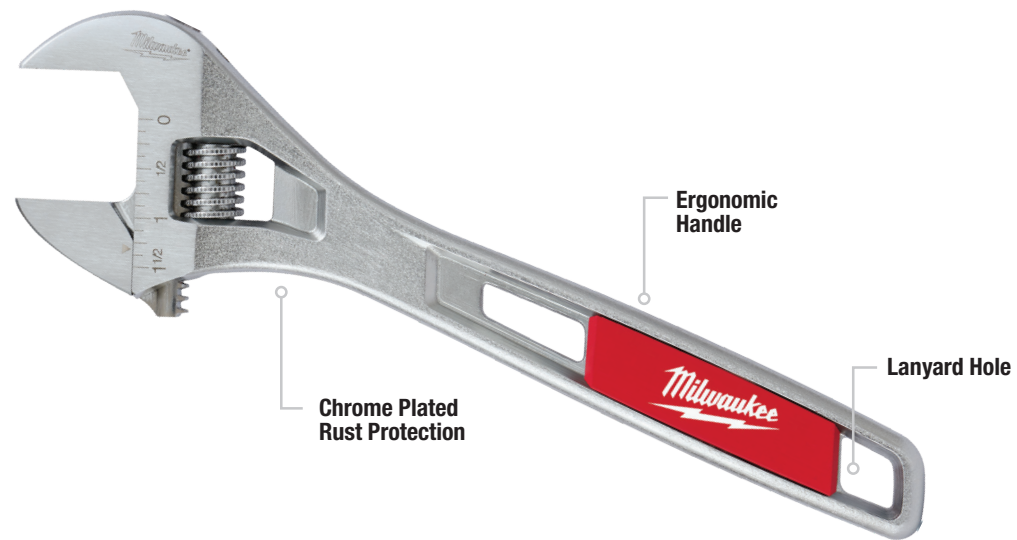
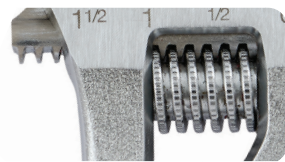

Perfectly Parallel Jaws

Model #	Description
48-22-7400	2 Pc 6" & 10" Adjustable Wrench Set
48-22-7406	6" Adjustable Wrench
48-22-7408	8" Adjustable Wrench
48-22-7410	10" Adjustable Wrench
48-22-7412	12" Adjustable Wrench
48-22-7415	15" Adjustable Wrench
48-22-7508	8" Wide Jaw Adjustable Wrench

BASIN WRENCHES

EASIEST SWAP-OUTS



Ratchet-Ready
Less jaw readjusting



Screwdriver-Ready
Up to 2x breakaway torque

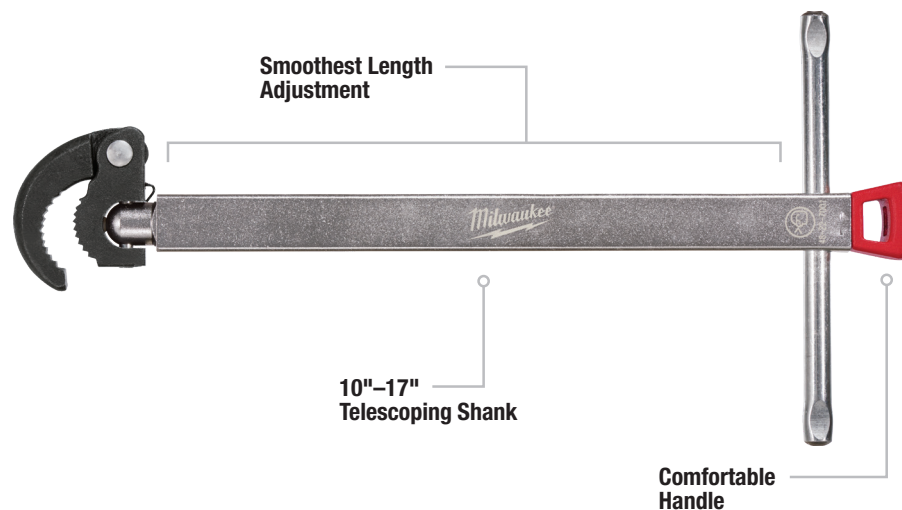

Model #	Description
48-22-7001	1-1/4" Basin Wrench
48-22-7002	2-1/2" Basin Wrench

CONTRACTOR RATCHET & SOCKET SETS

VERSATILE DESIGN. BETTER ACCESS.



Pivoting Head

Model #	Description
48-22-9000	12 Pc 3/8" SAE Contractor Ratchet & Socket Set with FOUR FLAT™ Sides
48-22-9001	12 Pc 3/8" Metric Contractor Ratchet & Socket Set with FOUR FLAT™ Sides

AUTOMOTIVE RATCHET & SOCKET SETS

MOST VERSATILE SOCKETS. ANTI-ROLL, WRENCH-READY.



Removable Storage Trays

MET Part #	Description
48-22-9404	26 Pc 1/4" SAE Drive Ratchet & Sockets with FOUR FLAT™ Sides
48-22-9408	28 Pc 3/8" SAE Drive Ratchet & Sockets with FOUR FLAT™ Sides
48-22-9504	28 Pc 1/4" Metric Drive Ratchet & Sockets with FOUR FLAT™ Sides
48-22-9014	1/4" Drive Ratchet
48-22-9508	32 Pc 3/8" Metric Drive Ratchet & Sockets with FOUR FLAT™ Sides
48-22-9004	50 Pc Metric & SAE 1/4" Drive Ratchet & Sockets with FOUR FLAT™ Sides
48-22-9008	56 Pc Metric & SAE 3/8" Drive Ratchet & Sockets with FOUR FLAT™ Sides
48-22-9038	3/8" Drive Ratchet

RATCHETING COMBINATION WRENCHES

BETTER ACCESS. LONGEST LIFE.



Durable Double Stacked Pawls

Model #	Description	Included Sizes
48-22-9406	7 Pc SAE Ratcheting Combination Wrench Set	3/8", 7/16", 1/2", 9/16", 5/8", 11/16", 3/4"
48-22-9506	7 Pc Metric Ratcheting Combination Wrench Set	8mm, 10mm, 12mm, 13mm, 14mm, 15mm, 17mm
48-22-9416	15 Pc SAE Ratcheting Combination Wrench Set	1/4", 9/32", 5/16", 11/32", 3/8", 7/16", 1/2", 9/16", 5/8", 11/16", 3/4", 13/16", 7/8", 15/16", 1"
48-22-9516	15 Pc Metric Ratcheting Combination Wrench Set	8mm, 9mm, 10mm, 11mm, 12mm, 13mm, 14mm, 15mm, 16mm, 17mm, 18mm, 19mm, 20mm, 21mm, 22mm

COMBINATION WRENCHES

UP TO 25% MORE TORQUE

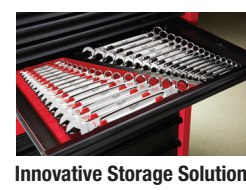

Innovative Storage Solution

Model #	Description	Included Sizes
48-22-9407	7 Pc SAE Combination Wrench Set	3/8", 7/16", 1/2", 9/16", 5/8", 11/16", 3/4"
48-22-9507	7 Pc Metric Combination Wrench Set	8mm, 10mm, 12mm, 13mm, 14mm, 15mm, 17mm
48-22-9415	15 Pc SAE Combination Wrench Set	1/4", 9/32", 5/16", 11/32", 3/8", 7/16", 1/2", 9/16", 5/8", 11/16", 3/4", 13/16", 7/8", 15/16", 1"
48-22-9515	15 Pc Metric Combination Wrench Set	8mm, 9mm, 10mm, 11mm, 12mm, 13mm, 14mm, 15mm, 16mm, 17mm, 18mm, 19mm, 20mm, 21mm, 22mm

PRY BARS

UP TO 40% MORE PRYING STRENGTH

I-BEAM DESIGN

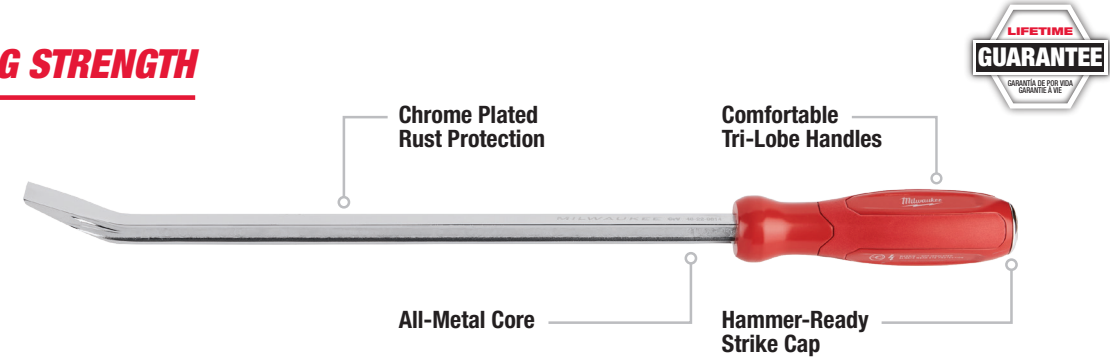

Easy Access Storage Tray

Model #	Description	Included Lengths
48-22-9214	4 Pc Pry Bar Set	8", 12", 18", 24"

HOOK AND PICK SET

UP TO 50% MORE DURABLE
ALL-METAL CORE

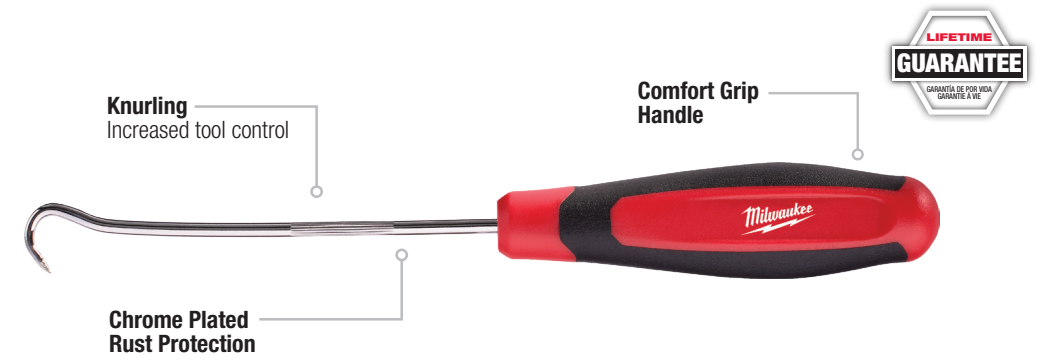

Easy Access Storage Tray

Model #	Description	Includes
48-22-9215	4 Pc Hook and Pick Set	Straight Pick, Offset Hook, Hook, 90° Hook

10 IN 1 MULTI-BIT / KEY DRIVERS

10IN1

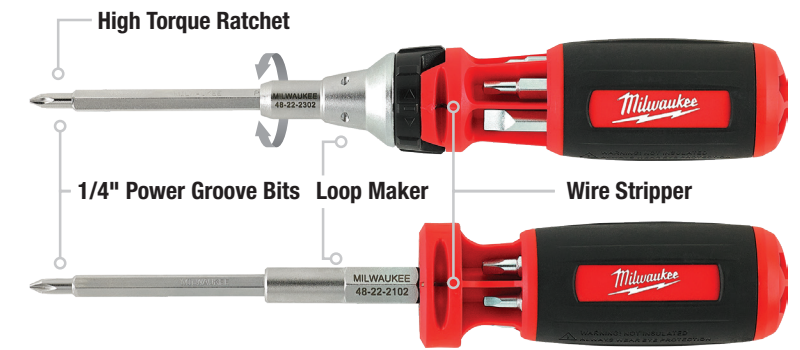

Power Tool Compatibility



In-Handle Storage

Model #	Description	Nut Drivers	Bit Types
48-22-2101	10in1 Multi-Bit Driver w/ ECX™	1/4"	P#1, P#2, SL 3/16", SL 1/4", SQ#2, ECX™#1, ECX™#2
48-22-2102	10in1 Square Multi-Bit Driver	1/4"	P#1, P#2, SL 3/16", SL 1/4", SQ#1, SQ#2, SQ#3
48-22-2301	10in1 Ratchet Multi-Bit Driver w/ ECX™	1/4"	P#1, P#2, SL 3/16", SL 1/4", SQ#2, ECX™#1, ECX™#2
48-22-2302	10in1 Ratchet Multi-Bit Driver w/ Square	1/4"	P#1, P#2, SL 3/16", SL 1/4", SQ#1, SQ#2, SQ#3
48-22-2103	10in1 TORX® Key Driver	1/4"	T8, T10, T15, T20, T25, T27, T30
48-22-2104	10in1 SAE Hex Key Driver	1/4"	7/64", 1/8", 9/64", 5/32", 3/16", 7/32", 1/4"
48-22-2106	10in1 Metric Hex Key Driver	1/4"	1.5mm, 2mm, 2.5mm, 3mm, 4mm, 5mm, 6mm
48-22-2110	4 Pc Replacement Bit Set		P#1, P#2, SL 3/16", SL 1/4", SQ #1, SQ#1, ECX™#1

8 IN 1 COMPACT MULTI-BIT DRIVERS

8IN1



Power Tool Compatibility



In-Handle Storage



Model #	Description	Nut Drivers	Bit Types
48-22-2120	Compact 8in1 Multi-Bit Driver	1/4"	P#1, P#2, SL 3/16", SL 1/4", SQ#1, SQ#2, T15
48-22-2320	Compact 8in1 Ratchet Multi-Bit Driver	1/4"	P#1, P#2, SL 3/16", SL 1/4", SQ#1, SQ#2, T15

11 IN 1 MULTI-BIT DRIVERS

11in1



Model #	Description	Nut Drivers	Bit Types
48-22-2760	11in1 Multi-Bit Driver w/ ECX™	1/4", 5/16", 3/8"	P#1, P#2, SL 3/16", SL 1/4", SQ#1, SQ#2, ECX™#1, ECX™#2
48-22-2761	11in1 Multi-Bit Driver w/ TORX®	1/4", 5/16", 3/8"	P#1, P#2, SL 3/16", SL 1/4", SQ#1, SQ#2, T10, T15

13 IN 1 CUSHION-GRIP SCREWDRIVERS

13in1

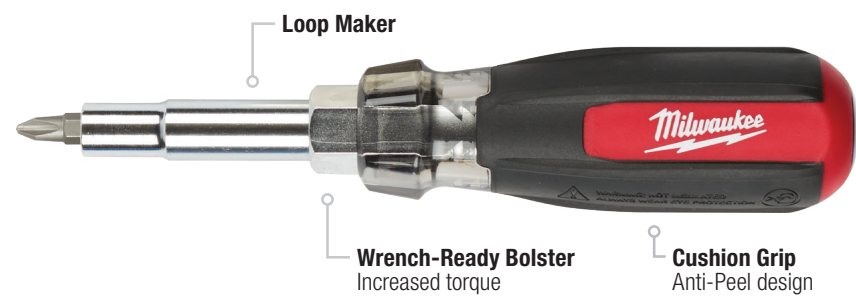

ECX™ Bit



Schrader® Valve Core Remover

Model #	Description	Nut Drivers	Bit Types
48-22-2880	13in1 Cushion-Grip Screwdriver with ECX™ Bit	1/4", 5/16", 3/8", 1/2"	P#1, P#2, SL 3/16", SL1/4", SQ#1, SQ#2, ECX™#1, ECX™#2
48-22-2881	13in1 Cushion-Grip Screwdriver with Schrader® Bit	1/4", 5/16", 3/8", 1/2"	P#1, P#2, SL 3/16", SL1/4", SQ#1, SQ#2, Std Schrader®, Large Schrader®

SCREWDRIVERS

HIGH-LEVERAGE HANDLE. MAGNETIC TIP.



Also Available:



Bottle Opener
48-22-2700



Comfortable Tri-Lobe Handle

Model #	Description	Bit Types
48-22-2702	2 Pc Demolition Screwdriver Set	P#2, SL 5/16"
48-22-2706	6 Pc Screwdriver Set	P#1, P#2, SL 3/16", SL 1/4", SL 5/16"
48-22-2708	8 Pc Screwdriver Set w/ ECX™	P#1, P#2, SL 3/16", SL 1/4", SL 5/16", ECX™#1, ECX™#2
48-22-2710	10 Pc Screwdriver Set	P#1, P#2, SL 3/16", SL 1/4", SL 5/16", SQ#1, SQ#2
48-22-2718	8 Pc Screwdriver Set w/ Square	P#1, P#2, SL 3/16", SL 1/4", SL 5/16", SQ#1, SQ#2
48-22-2700	Bottle Opener	

CUSHION-GRIP SCREWDRIVERS

MOST DURABLE HANDLE. PRECISION TIP.

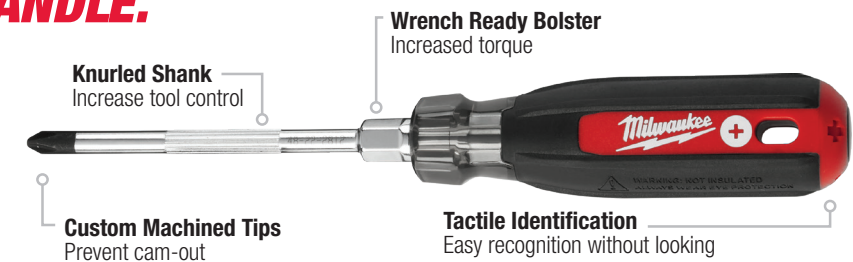

Anti-Peel Design Cushion Grips

Model #	Description	Model #	Description	Model #	Description
48-22-2811	#1 Phillips (3")	48-22-2821	1/4" Slotted (4")	48-22-2841	#1 ECX™ (4")
48-22-2812	#2 Phillips (4")	48-22-2822	5/16" Slotted (6")	48-22-2842	#2 ECX™ (4")
48-22-2813	#3 Phillips (6")	48-22-2824	3/8" Slotted (8")	48-22-2851	#1 Square (3")
48-22-2814	#2 Phillips (10")	48-22-2831	3/16" Cabinet (3")	48-22-2852	#2 Square (4")
48-22-2815	#2 Phillips (6") Cushion-Grip Demolition Screwdriver	48-22-2832	3/16" Cabinet (6")	48-22-2853	#3 Square (6")
		48-22-2833	3/16" Cabinet (8")	48-22-2884	4 Pc Set
		48-22-2834	1/4" Cabinet (10")	48-22-2886	6 Pc Set

DEMO DRIVER

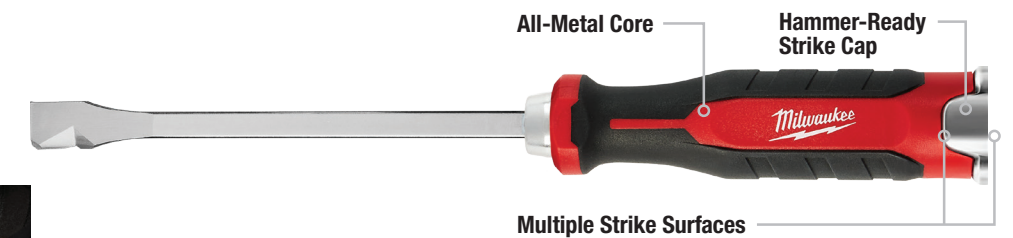

Aggressive Duct Piercing Tip

Model #	Description
48-22-2860	Demo Driver
48-22-2823	Slotted 5/16" 6" Cushion-Grip Demolition Screwdriver
48-22-2825	Slotted 3/8" 8" Cushion-Grip Demolition Screwdriver

1000V INSULATED SCREWDRIVERS

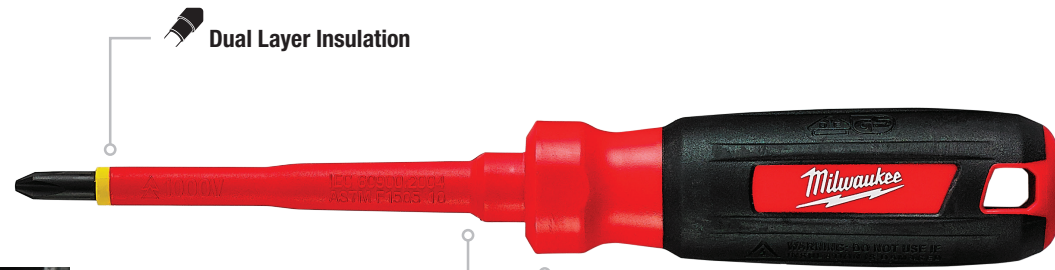

Dual Layer Insulation

Flame & Impact Resistant

1000V
IEC 60900:2012 | ASTM F1505-10 | NFPA 70E

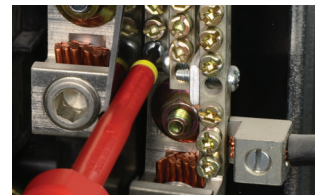

Slim Drive Shaft

Allows access in recessed applications

Model #	Description	Model #	Description	Model #	Description	Bit Types, Carrying Case
48-22-2211	#1 Phillips (3")	48-22-2232	3/16" Cabinet (6")	48-22-2202	3 Pc 1000V Insulated Screwdriver Set	P#2, SL 1/4", ECX™#1
48-22-2212	#2 Phillips (4")	48-22-2233	3/16" Cabinet (8")	48-22-2204	4 Pc 1000V Insulated Screwdriver Set w/ Case	P#1, P#2, SL 1/4", SL 3/8", Extra Capacity Roll Up Pouch
48-22-2213	#3 Phillips (6")	48-22-2241	#1 ECX™ (4")	48-22-2205	4 Pc 1000V Insulated Screwdriver Set w/ Case	SL 1/4", SL 3/8", SQ#1, SQ#2, Extra Capacity Roll Up Pouch
48-22-2221	1/4" Slotted (6")	48-22-2242	#2 ECX™ (4")	48-22-2210	10 Pc 1000V Insulated Screwdriver Set w/ Case	P#1, P#2, P#3, SL 1/4", SL 5/16", SL 3/8", SQ#1, SQ#2, SQ#3, ECX™#1, EVA Foam Fitted Case
48-22-2222	5/16" Slotted (7")	48-22-2251	#1 Square (3")	48-22-2203	3 Pc 1000V Insulated Screwdriver Set	#1 ECX™ (4"), #2 Phillips (4"), 1/4" Slotted (6")
48-22-2223	3/8" Slotted (8")	48-22-2252	#2 Square (4")			
48-22-2224	3/8" Slotted (10")	48-22-2253	#3 Square (6")			
48-22-2231	3/16" Cabinet (4")					

PRECISION SCREWDRIVERS

UP TO **4X STRONGER**

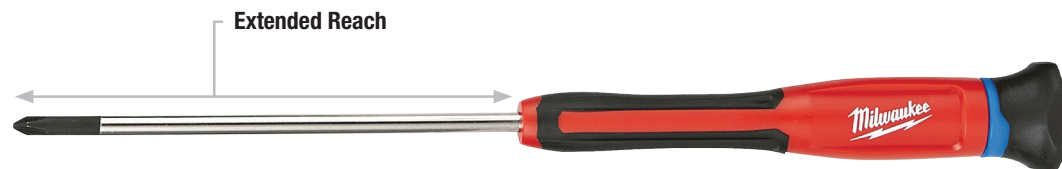

Extended Reach

360° Rotating & Impact Resistant Back Cap

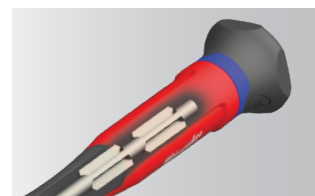

All-Metal Core

Model #	Description	Bit Types
48-22-2604	4 Pc Precision Screwdriver Set	P#1, SL 1/16", SL 3/32", SL 1/8"
48-22-2606	6 Pc Precision Screwdriver Set w/ Case	P#1, P#2, SL 1/16", SL 3/32", SL 1/8", SL 5/32"
48-22-2610	6 Pc TORX® Precision Screwdriver Set w/ Case	T6, T7, T8, T9, T10, T15

HOLLOWCORE™ MAGNETIC NUT DRIVERS

UNLIMITED DEPTH
FITS **4X MORE FASTENERS**

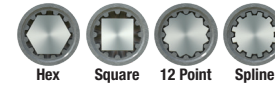

SAE METRIC

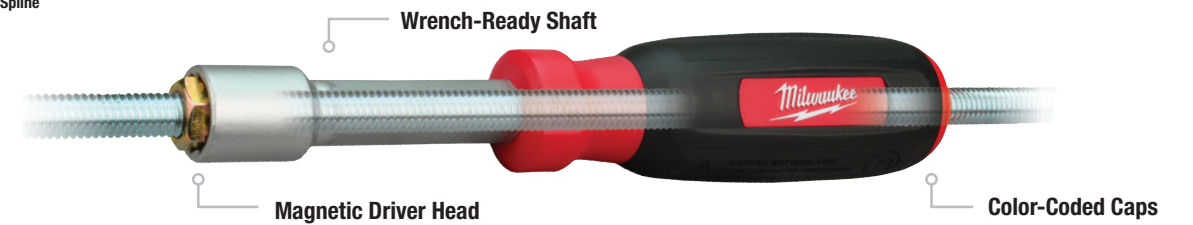

Wrench-Ready Shaft

Magnetic Driver Head

Color-Coded Caps

Model #	Description
48-22-2520	3/16" Magnetic Nut Driver
48-22-2521	1/4" HOLLOWCORE™ Magnetic Nut Driver
48-22-2522	5/16" HOLLOWCORE™ Magnetic Nut Driver
48-22-2523	11/32" HOLLOWCORE™ Magnetic Nut Driver
48-22-2524	3/8" HOLLOWCORE™ Magnetic Nut Driver

Model #	Description	Sizes
48-22-2502	2 Pc HOLLOWCORE™ Magnetic Nut Driver Set	1/4", 5/16"
48-22-2507	7 Pc HOLLOWCORE™ SAE Magnetic Nut Driver Set	1/4", 5/16", 11/32", 3/8", 7/16", 1/2", 9/16"
48-22-2517	7 Pc HOLLOWCORE™ Metric Magnetic Nut Driver Set	5mm, 5.5mm, 6mm, 7mm, 8mm, 10mm, 13mm

Model #	Description
48-22-2525	7/16" HOLLOWCORE™ Magnetic Nut Driver
48-22-2526	1/2" HOLLOWCORE™ Magnetic Nut Driver
48-22-2527	9/16" HOLLOWCORE™ Magnetic Nut Driver
48-22-2531	5mm HOLLOWCORE™ Magnetic Nut Driver
48-22-2532	5.5mm HOLLOWCORE™ Magnetic Nut Driver

Model #	Description
48-22-2533	6mm HOLLOWCORE™ Magnetic Nut Driver
48-22-2534	7mm HOLLOWCORE™ Magnetic Nut Driver
48-22-2535	8mm HOLLOWCORE™ Magnetic Nut Driver
48-22-2536	10mm HOLLOWCORE™ Magnetic Nut Driver
48-22-2537	13mm HOLLOWCORE™ Magnetic Nut Driver

HOLLOW SHAFT NUT DRIVERS

FITS **4X MORE FASTENERS**

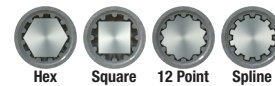

SAE METRIC

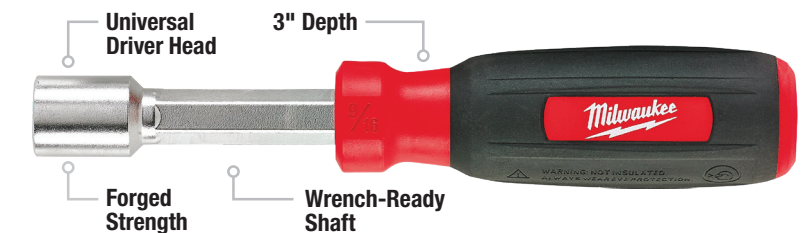

Universal Driver Head

3" Depth

Forged Strength

Wrench-Ready Shaft

Model #	Description	Sizes
48-22-2402	2 Pc SAE Hollow Shaft Nut Driver Set	1/4", 5/16"
48-22-2404	4 Pc SAE Hollow Shaft Nut Driver Set	1/4", 5/16", 7/16", 9/16"
48-22-2407	7 Pc SAE Hollow Shaft Nut Driver Set	1/4", 5/16", 11/32", 3/8", 7/16", 1/2", 9/16"
48-22-2417	7 Pc Metric Hollow Shaft Nut Driver Set	5mm, 5.5mm, 6mm, 7mm, 8mm, 10mm, 13mm

Model #	Description
48-22-2420	3/16" Hollow Shaft Nut Driver
48-22-2421	1/4" Hollow Shaft Nut Driver
48-22-2422	5/16" Hollow Shaft Nut Driver
48-22-2423	11/32" Hollow Shaft Nut Driver
48-22-2424	3/8" Hollow Shaft Nut Driver

Model #	Description
48-22-2425	7/16" Hollow Shaft Nut Driver
48-22-2426	1/2" Hollow Shaft Nut Driver
48-22-2427	9/16" Hollow Shaft Nut Driver
48-22-2431	5mm Hollow Shaft Nut Driver
48-22-2432	5.5mm Hollow Shaft Nut Driver

Model #	Description
48-22-2433	6mm Hollow Shaft Nut Driver
48-22-2434	7mm Hollow Shaft Nut Driver
48-22-2435	8mm Hollow Shaft Nut Driver
48-22-2436	10mm Hollow Shaft Nut Driver
48-22-2437	13mm Hollow Shaft Nut Driver

FRAMING HAMMERS

UP TO **10X VIBRATION REDUCTION**
SHOCKSHIELD® GRIP

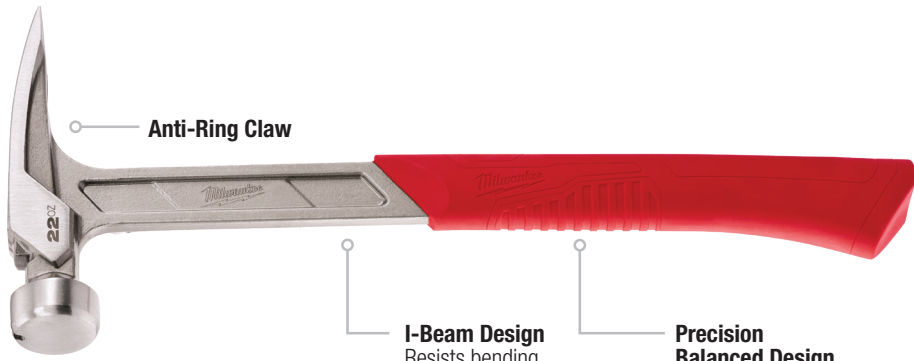
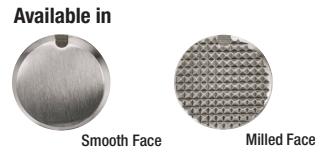

Model #	Description
48-22-9016	17oz Milled Face Hammer
48-22-9017	17oz Smooth Face Hammer
48-22-9022	22oz Milled Face Hammer

Model #	Description
48-22-9023	22oz Smooth Face Hammer
48-22-9080	20oz Curved Claw Hammer

POLY FIBERGLASS HAMMER

MOST DURABLE FIBERGLASS HANDLE



Model #	Description
48-22-9316	19oz Smooth Face Poly Fiberglass Hammer

HICKORY HAMMER

BEST DRIVING PERFORMANCE



Model #	Description
48-22-9419	19oz Hickory Hammer - Milled Face
48-22-9419	19oz Hickory Hammer - Smooth Face

HAND CLAMPS

UP TO **2X CLAMP FORCE**
+STOP LOCK™



Model #	Description
48-22-3002	2" Hand Clamp
48-22-3004	4" Hand Clamp

HAWKBILL KNIVES

STAYS SHARPER LONGER



Durable Sheath



Model #	Description
48-22-1925	Hawkbill Fixed Blade Knife

FIXED BLADE KNIVES

STAYS SHARPER LONGER



Durable Sheath



Model #	Description
48-22-1926	4" Fixed Blade Knife

HARDLINE™ FIXED BLADE KNIVES

ULTIMATE DURABILITY™
AUS-8 STEEL™



Multi-Position Sheath



Model #	Description
48-22-1928	5" HARDLINE™ Fixed Blade Knife
48-22-1928B	5" HARDLINE™ Fixed Blade Knife

HARDLINE™ POCKET KNIVES

EXTREME WEAR RESISTANCE™
D2 STEEL™



Model #	Description	Model #	Description
48-22-1994	HARDLINE™ 3" Smooth Blade Pocket Knife	48-22-1998	HARDLINE™ 3" Serrated Blade Pocket Knife
48-22-1997	HARDLINE™ 2-1/2" Smooth Blade Pocket Knife	48-22-1999	HARDLINE™ 3-1/2" Smooth Blade Pocket Knife

FASTBACK™ SPRING ASSISTED KNIVES

Spring Assisted

Black Oxide Stainless Steel Blade | One-Hand Blade Opening | Lanyard Hole | Liner Lock | Reversible Belt Clip

Also Available:
FASTBACK™ Camo Spring Assisted Knife 48-22-1996

Model #	Description
48-22-1995	FASTBACK™ Spring Assisted Knife
48-22-1996	FASTBACK™ Camo Spring Assisted Knife

Ideal for Piercing & Tearing

FASTBACK™ HAWKBILL FLIP KNIVES

PRESS AND FLIP™

Stainless Steel Blade | One-Hand Blade Opening | Lanyard Hole | Liner Lock | Reversible Belt Clip

Model #	Description
48-22-1985	FASTBACK™ Hawkbill Flip Knife

Ideal for Piercing & Tearing

FASTBACK™ FLIP KNIVES

PRESS AND FLIP™

Stainless Steel Blade | One-Hand Blade Opening | Lanyard Hole | Liner Lock | Reversible Belt Clip

Model #	Description
48-22-1985	FASTBACK™ Hawkbill Flip Knife
48-22-1990	FASTBACK™ Flip Knife

Ideal for Controlled Slicing

LOCKBACK POCKET KNIFE

Nail Nick Easy open | Lockback Strong secure hold | Lanyard Hole | Stainless Steel Smooth Blade | Reversible Belt Clip

Model #	Description
48-22-1940	Lockback Pocket Knife

FASTBACK™ FLIP UTILITY KNIFE WITH BLADE STORAGE

PRESS AND FLIP™

Magnetic 4-Blade Storage | Tool-Free Blade Change | Blade Locks at 45° | Wire Stripper | One-Hand Blade Opening | Lanyard Hole | All-Metal Body

Quick Change

Model #	Description
48-22-1903	FASTBACK™ Flip Utility Knife with Blade Storage

FASTBACK™ FLIP UTILITY KNIFE

PRESS AND FLIP™

Tool-Free Blade Change | One-Hand Blade Opening | Gut Hook | All-Metal Body | Wire Stripper

Quick Change

Model #	Description
48-22-1901	FASTBACK™ Flip Utility Knife

FASTBACK™ COMPACT FLIP UTILITY KNIFE

PRESS AND FLIP™

Tool-Free Blade Change | One-Hand Blade Opening | Lanyard Hole

Quick Change

Model #	Description
48-22-1906	FASTBACK™ Compact Flip Utility Knife

SIDE SLIDING UTILITY KNIFE

MAXIMUM DEPTH CONTROL

Tool-Free Blade Change | Side Sliding Blade Activation | Wire Stripper | Rubber Overmold

Blade Storage

Model #	Description
48-22-1910	Side Sliding Utility Knife

SAFETY UTILITY KNIFE



SAFETY CUTTER

UP TO **5X LONGER LIFE**

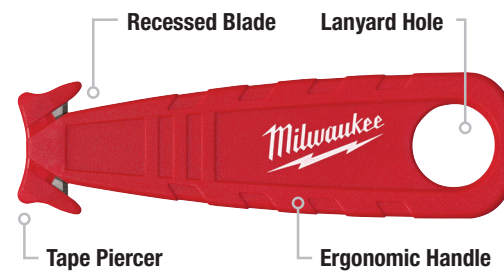

2 Blade Positions

Model #	Description
48-22-1915	Safety Utility Knife

Model #	Description
48-22-1916	Safety Cutter

PRECISION SNAP-OFF KNIFE

METAL LOCK
UP TO **10X LONGER LIFE**

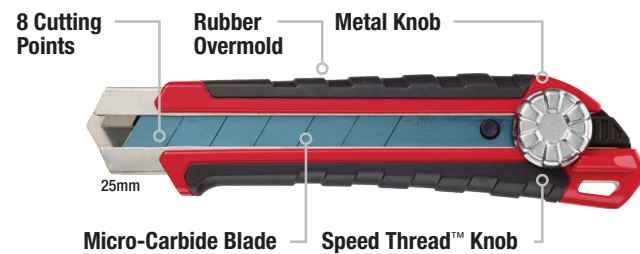

Model #	Description
48-22-1960	9mm (A) Precision Snap-Off Knife
48-22-1961	18mm (L) Precision Snap-Off Knife w/ Metal Lock

Model #	Description
48-22-1962	25mm (H) Precision Snap-Off Knife w/ Metal Lock

Description	3 Pc	10 Pc
9mm (A) Precision Snap-Off Replacement Blades	48-22-9309	48-22-9109
18mm (L) Precision Snap-Off Replacement Blades	48-22-9318	48-22-9118
25mm (H) Precision Snap-Off Replacement Blades	48-22-9325	48-22-9125



Blade Snap Off

GENERAL PURPOSE SNAP-OFF KNIFE

FASTER BLADE ADJUSTMENT

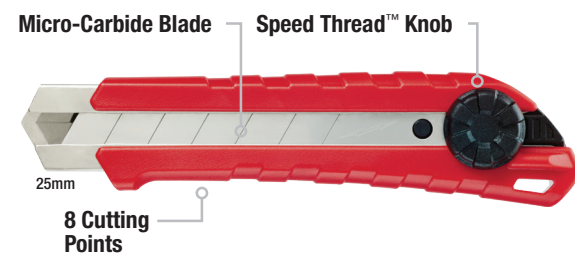

Model #	Description
48-22-1963	9mm (A) General Purpose Snap-Off Knife
48-22-1964	18mm (L) General Purpose Snap-Off Knife

Model #	Description
48-22-1965	25mm (H) General Purpose Snap-Off Knife

Description	3 Pc	10 Pc
9mm (A) General Purpose Snap-Off Replacement Blades	48-22-1309	48-22-1109
18mm (L) General Purpose Snap-Off Replacement Blades	48-22-1318	48-22-1118
25mm (H) General Purpose Snap-Off Replacement Blades	48-22-1325	48-22-1125



Blade Snap Off

GENERAL PURPOSE

LASTS **5X LONGER**



General Purpose



HOOK

UP TO **2X STRONGER**



Ideal for Roofing



DRYWALL

UP TO **2X SHARPER**



Ideal for Drywall



CARTON

LASTS **5X LONGER**



Ideal for Cartons



Description	5 Pc	50 Pc (Dispenser Included)	75 Pc (Dispenser Included)	100 Pc (Dispenser Included)
General Purpose Utility Blades	48-22-1905	48-22-1950	48-22-1975	48-22-1900
Hook Utility Blades	48-22-1932	48-22-1952	–	–
Drywall Utility Blades	48-22-1933	48-22-1953	–	–
Carton Utility Blades	48-22-1934	48-22-1954	–	–

INSULATION KNIVES

STAYS SHARPER LONGER

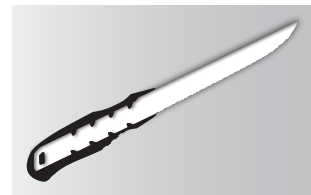
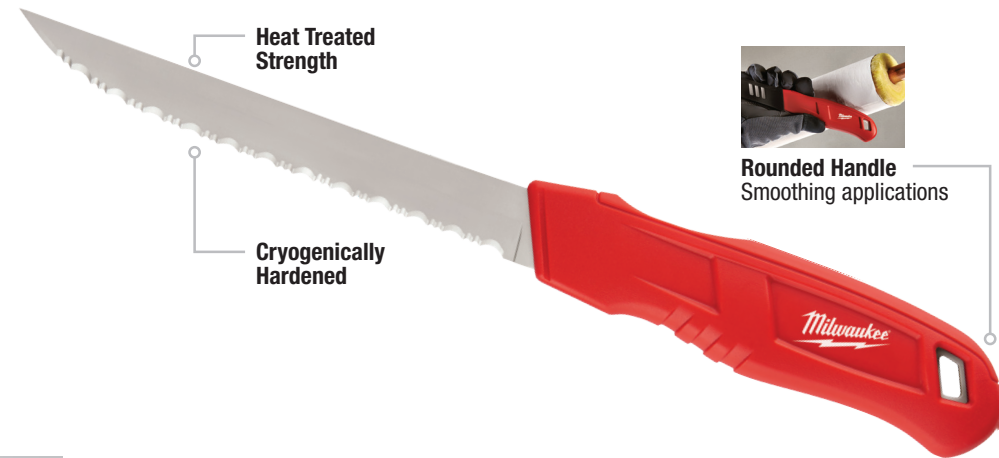

Full Tang

Model #	Description
48-22-1921	Insulation Knife (Smooth)
48-22-1922	Insulation Knife (Serrated)

DUCT KNIFE

STAYS SHARPER LONGER

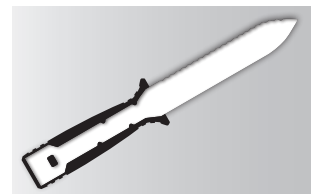
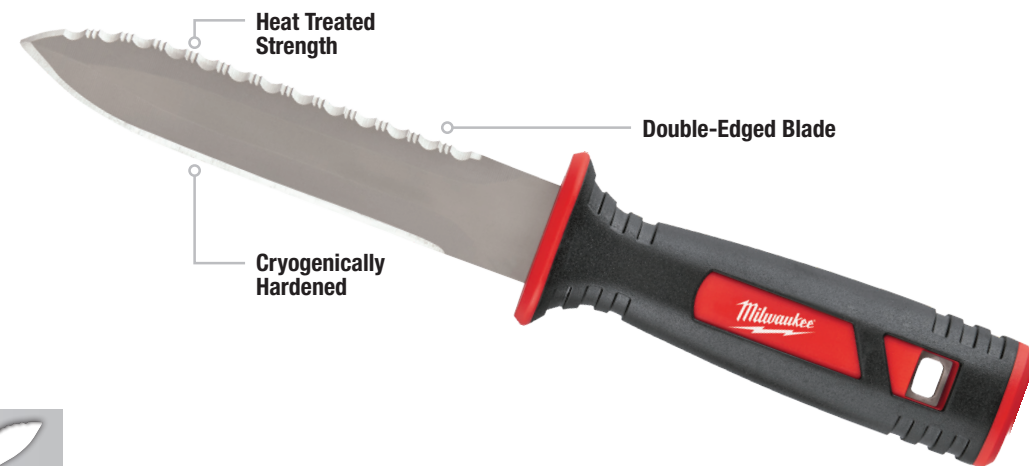

Full Tang

Model #	Description
48-22-1920	Duct Knife

AVIATION SNIPS

UP TO 10x MORE CUTS FORGED BLADES



Flush Bolt Design
Won't hang up on material

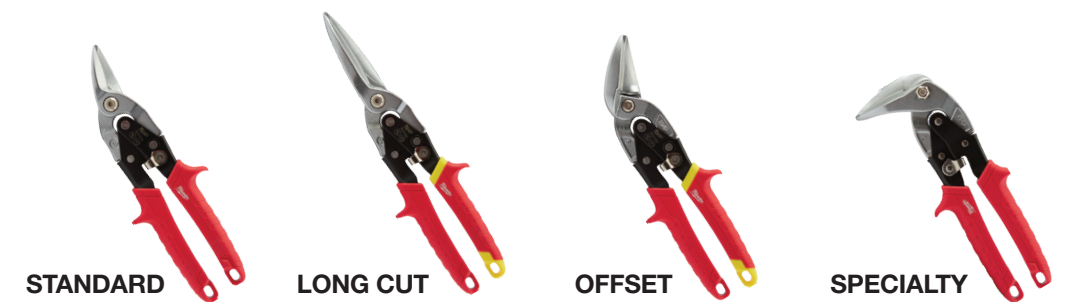

Model #	Description	Cold Rolled Steel	Stainless Steel
48-22-4530	Straight Cutting Standard Snips	18ga	22ga
48-22-4510	Left Cutting Standard Snips	18ga	22ga
48-22-4520	Right Cutting Standard Snips	18ga	22ga
48-22-4533	3 Pc Standard Snips Set	18ga	22ga
48-22-4532	Straight Cutting Offset Snips	18ga	22ga
48-22-4512	Left Cutting Offset Snips	18ga	22ga
48-22-4522	Right Cutting Offset Snips	18ga	22ga

Model #	Description	Cold Rolled Steel	Stainless Steel
48-22-4523	2 Pc Offset Snips Set	18ga	22ga
48-22-4537	Long Cut Straight Cutting Snips	20ga	22ga
48-22-4538	Long Cut Offset Snips	20ga	22ga
48-22-4500	Bulldog Snips	16ga	18ga
48-22-4511	Left Cutting Right Angle Snips	24ga	28ga
48-22-4521	Right Cutting Right Angle Snips	24ga	28ga

OFFSET COMPOUND TINNERS

TOUGH CUTS
2X FORCE, LESS EFFORT



45° Offset Cut clearance

Model #	Description
48-22-4005	Offset Compound Tinner

CLASSIC TINNERS

BLADES WILL NOT LOOSEN
BOLT LOCK



40% Larger Handle Loops

Model #	Description
48-22-4003	10" Classic Tinner
48-22-4002	12" Classic Tinner
48-22-4001	16" Bulldog Tinner

DUCKBILL TINNER

BLADES WILL NOT LOOSEN
BOLT LOCK



40% Larger Handle Loops

Model #	Description
48-22-4004	10" Duckbill Tinner

LIGHTWEIGHT TINNER

STRAIGHTER, CLEANER CUTS



40% Larger Handle Loops

Model #	Description
48-22-4006	13" Lightweight Tinner
48-22-4007	Lightweight Tinner Replacement Blades

JOBSITE SCISSORS

ALL-METAL HANDLES
UP TO 10X LONGER LIFE



Index Finger Groove

Model #	Description
48-22-4040	Offset Jobsite Scissors (Serrated)

Model #	Description
48-22-4041	Straight Jobsite Scissors (Smooth)

SPEED SEAMER™

FASTER, MORE ACCURATE HVAC FOLDS



3/8" & 1" Markings
More accurate folds

Model #	Description
48-22-6000	3" SPEED SEAMER™

CRIMPER

UP TO 2X LONGER LIFE

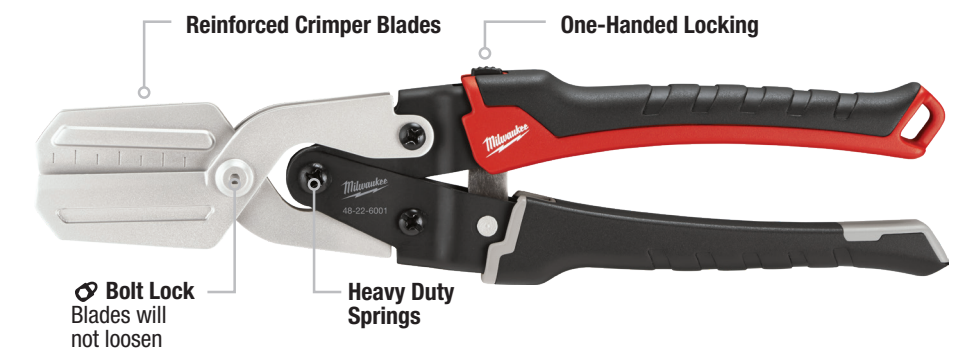

Symmetrical Handles
Over-hand grip

Model #	Description
48-22-6001	5-Blade Crimper

ADAPTABLE BOLT CUTTERS W/ POWERMOVE™ EXTENDABLE ARMS

**MORE CUTS.
MAXIMUM VERSATILITY.**



POWERMOVE™
Extendable Arms

Model #	Description	Max Capacity	
		Soft/Medium Materials (up to 31 HRC)	Hard Materials (up to 48 HRC)
48-22-4114	14" Adaptable Bolt Cutter	5/16"	3/16"
48-22-4124	24" Adaptable Bolt Cutter	7/16"	5/16"

BOLT CUTTERS

**MORE CUTS.
LONGER LIFE.**

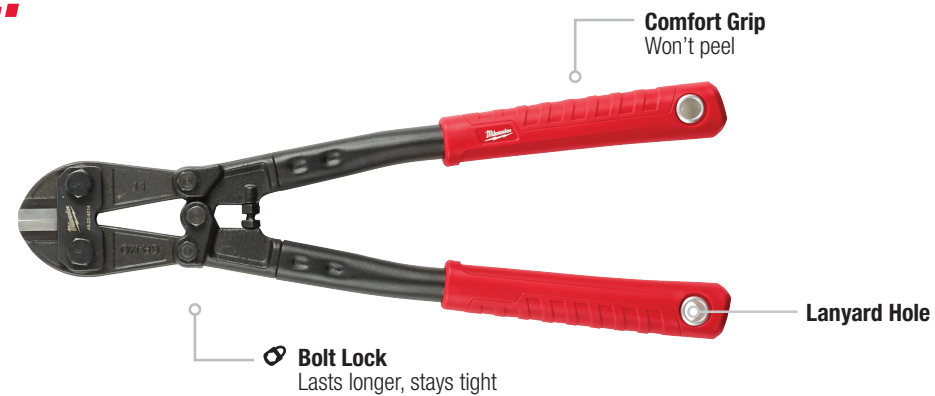

Forged Steel Blades &
Custom Heat Treated
Maximum durability

Model #	Description	Max Capacity	
		Soft/Medium Materials (up to 31 HRC)	Hard Materials (up to 48 HRC)
48-22-4014	14" Bolt Cutter	5/16"	3/16"
48-22-4024	24" Bolt Cutter	7/16"	5/16"

HIGH-TENSION HACKSAW

**MOST DURABLE.
HIGHEST TENSION.**

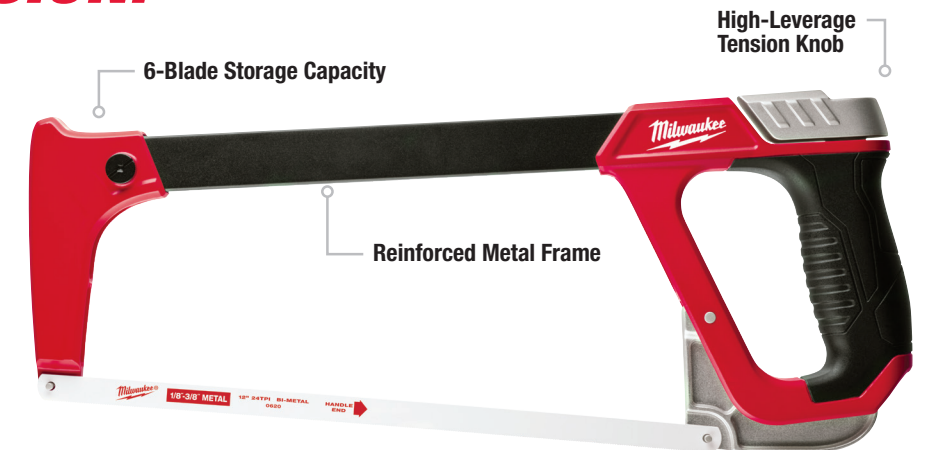

45° Angle Blade Position

Model #	Description
48-22-0050	10 Pc 12" High-Tension Hacksaw
48-43-0600	10 Pc 12" 14TPI Hacksaw Blade
48-43-0610	10 Pc 12" 18TPI Hacksaw Blade

Model #	Description
48-43-0620	10 Pc 12" 24TPI Hacksaw Blade
48-43-0630	10 Pc 12" 32TPI Hacksaw Blade

COMPACT HACKSAW

UP TO 10X FASTER BLADE CHANGE



Compact Design

Model #	Description
48-22-0012	Compact Hacksaw

RASPING JAB SAW

UP TO **2X FASTER PLUNGE CUTS**



Piercing Tip

Model #	Description
48-22-0304	Rasping Jab Saw

FOLDING JAB SAW

UP TO **10X FASTER BLADE CHANGE**



Folding Blade

Model #	Description
48-22-0305	Folding Jab Saw

PVC/ABS SAW

FAST CUTS THROUGH PVC



Metal Core

Model #	Description
48-22-0212	12" PVC/ABS Saw
48-22-0222	12" PVC/ABS Saw Replacement Blade
48-22-0223	18" PVC/ABS Saw
48-22-0220	18" PVC/ABS Saw Replacement Blade

TUBING CUTTER

INDESTRUCTIBLE FRAME



Replaceable Blades

Model #	Description
48-22-4202	Tubing Cutter
48-22-4203	Tubing Cutter Replacement Blade

RATCHETING PIPE CUTTERS

STRAIGHT, EASY CUTS



Comfortable Handle Design

Model #	Description	Model #	Description
48-22-4210	1-5/8" Ratcheting Pipe Cutter	48-22-4215	2-3/8" Ratcheting Pipe Cutter
48-22-4211	1-5/8" Ratcheting Pipe Cutter Replacement Blade	48-22-4216	2-3/8" Ratcheting Pipe Cutter Replacement Blade

REAMING PEN

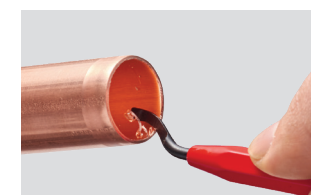

Copper



PVC



Model #	Description
48-22-4255	Reaming Pen

MINI COPPER TUBING CUTTERS

5X LONGER LIFE
REINFORCED ADJUSTMENT MECHANISM



Chrome Rollers Rust Protection

Model #	Description	Cut Capacity	Extra Blade
48-22-4250	1/2" Mini Copper Tubing Cutter	1/8"–5/8"	
48-22-4258	3/4" Mini Copper Tubing Cutter	1/8"–7/8"	
48-22-4251	1" Mini Copper Tubing Cutter	1/8"–1-1/8"	Yes
48-22-4256	2 Pc Replacement Cutter Wheels		

CLOSE QUARTERS COPPER TUBING CUTTERS

MOST COMPACT.
LONGEST LIFE.



Chrome Rollers Rust Protection

Model #	Description
48-22-4260	1/2" Close Quarters Copper Tubing Cutter
48-22-4261	3/4" Close Quarters Copper Tubing Cutter
48-22-4262	1" Close Quarters Copper Tubing Cutter
48-22-4263	3 Pc Close Quarters Copper Tubing Cutter Set
48-22-4266	Replacement Copper Tubing Cutter Wheels

QUICK-ADJUST TUBING CUTTERS

STRAIGHTER,
CLEANER CUTS
4 CHROME ROLLERS



Adapt to Cut 3" PEX



Chrome Rollers Rust Protection



Model #	Description	Cut Capacity
48-22-4253	2-1/2" Quick-Adjust Copper Tubing Cutter	1/2"–2-5/8"
48-22-4254	3-1/2" Quick-Adjust Copper Tubing Cutter	1/2"–3-1/2"
48-22-4256	2 Pc Replacement Cutter Wheels	
48-22-4206	Replacement PEX Cutter Wheel	

CONSTANT SWING COPPER TUBING CUTTERS

STRAIGHTER,
CLEANER CUTS
4 CHROME ROLLERS



Built-In Reamer on 48-22-4252



Chrome Rollers Rust Protection



Model #	Description	Cut Capacity
48-22-4259	1" Constant Swing Copper Tubing Cutter	1/8"–1-1/8"
48-22-4252	1-1/2" Constant Swing Copper Tubing Cutter	1/8"–1-5/8"
48-22-4256	2 Pc Replacement Cutter Wheels	
48-22-4257	3 Pc Replacement Reaming Blade	

PUNCHDOWN TOOL

**BEST ACCESS
& VISIBILITY**

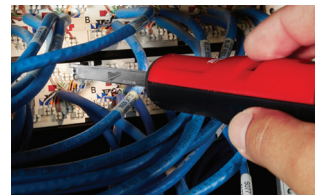

Extended Reach Punchdown Blade

Model #	Description	Blades Included
48-22-2165	Punchdown Tool with Extended Blade	66/110 Combination and Extended Reach 110
48-22-2166	Extended Punchdown Blade	Extended Reach 110
48-22-2167	Punchdown Blade	66/110 Combination

MINI FLUSH CUTTER

**CONSISTENT,
PRECISE CUTS**



Spring Assisted

Model #	Description
48-22-6105	Mini Flush Cutter

RATCHETING MODULAR CRIMPER

**CONSISTENT,
ACCURATE CRIMPS**



Parallel Crimping Design

Model #	Description
48-22-3075	Ratcheting Modular Crimper

MULTI-PICK TOOL

4in1

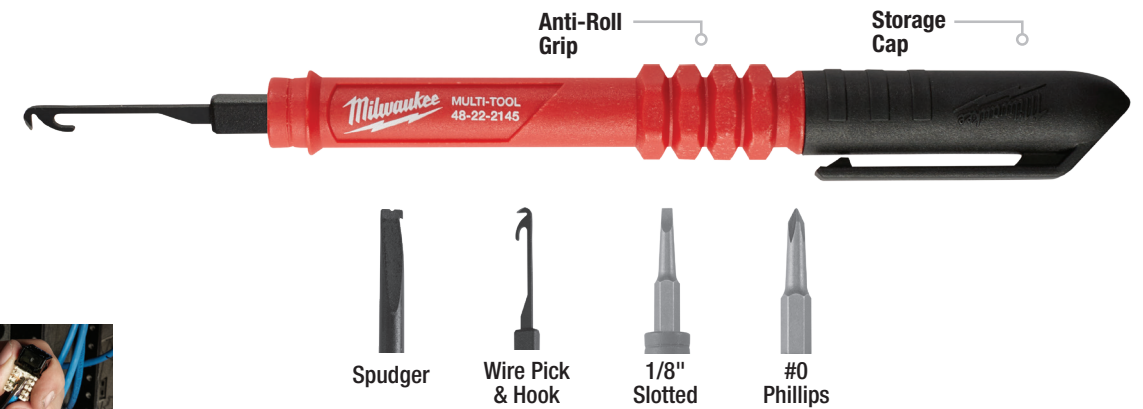

Model #	Description
48-22-2145	Multi-Pick Tool

ELECTRICIAN SNIPS

**BLADES WON'T LOOSEN.
BOLT LOCK**



Wire Gullet Prevents Walking

Model #	Description
48-22-4045	Electrician Snips

UTP STRIPPER

**COMFORTABLE,
ONE HAND OPERATION**



Optimized Finger Loop

Model #	Description
48-22-3065	UTP Stripper



PACKOUT™

**MOST VERSATILE
DURABLE**
MODULAR STORAGE SYSTEM



**FULLY
CUSTOMIZE
YOUR STORAGE™**



**IMPACT
RESISTANT™**



**IP65
RATED
PROTECTION™**



**BUILD
YOUR SYSTEM**

PACKOUT™ ROLLING TOOL BOX



**250 LBS
CAPACITY™**



**IMPACT
RESISTANT
BODY™**



**9" ALL-
TERRAIN
WHEELS™**



9" All-Terrain Wheels

Modular Connectivity
with All PACKOUT™
Components

Metal
Reinforced
Locking Point

IP65 Rated
Protection



Industrial-Grade
Extension Handle

Interior
Organization
Tray

Metal Reinforced
Corners

Model #	Description	Carrying Capacity
48-22-8426	PACKOUT™ Rolling Tool Box	250 lbs

PACKOUT™ TOOL BOXES



**100 LBS
CAPACITY™**



**IMPACT
RESISTANT
BODY™**



**METAL-
REINFORCED
TOP HANDLE™**



Interior Organizer Trays

Metal Reinforced
Locking Point

IP65 Rated
Protection



Modular Connectivity
with All PACKOUT™
Components

Metal Reinforced
Corners

Also Available:



PACKOUT™ Tool Box
48-22-8424

Model #	Description	Carrying Capacity
48-22-8424	PACKOUT™ Tool Box	75 lbs
48-22-8425	PACKOUT™ Large Tool Box	100 lbs

PACKOUT™ ORGANIZERS



Modular Connectivity with All PACKOUT™ Components



No-Travel Bin Seals

Also Available:



PACKOUT™ Compact Organizer
48-22-8435



Removable & Mountable Bins

Model #	Description
48-22-8435	PACKOUT™ Compact Organizer
48-22-8430	PACKOUT™ Organizer

PACKOUT™ LOW-PROFILE ORGANIZERS



No-Travel Bin Seals

Modular Connectivity with All PACKOUT™ Components

6 Removable Bin Dividers

IP65 Rated Protection



Impact Resistant Polymer Base

Low-Profile Design

Also Available:



PACKOUT™ Low-Profile Compact Organizer
48-22-8436



Removable Bins

Model #	Description
48-22-8431	PACKOUT™ Low-Profile Organizer
48-22-8436	PACKOUT™ Low-Profile Compact Organizer

PACKOUT™ TOTES



Padded Removable Shoulder Strap

Durable Overmold Handle

Modular Connectivity with All PACKOUT™ Components



Also Available:



PACKOUT™ 10" Tote
48-22-8310



PACKOUT™ 15" Tote
48-22-8315



1680D Ballistic Nylon

Model #	Description	Tool Pockets
48-22-8310	PACKOUT™ 10" Tote	28
48-22-8315	PACKOUT™ 15" Tote	31
48-22-8320	PACKOUT™ 20" Tote	32

PACKOUT™ TOOL BAGS



Versatile Carry Cushioned Shoulder Strap, Top Handles, Side Handles

All-Metal Hardware

Modular Connectivity with All PACKOUT™ Components

Impact Resistant Polymer Base



Also Available:



PACKOUT™ 20" Tool Bag
48-22-8322



1680D Ballistic Nylon

Model #	Description
48-22-8321	PACKOUT™ 15" Tool Bag
48-22-8322	PACKOUT™ 20" Tool Bag

HARDTOP™ ROLLING BAGS

**MOST DURABLE.
ULTIMATE VERSATILITY.**



1680D Ballistic Nylon

Model #	Description
48-22-8221	18" Rolling Bag
48-22-8220	24" HARDTOP™ Rolling Bag

JOBSITE TECH BAG

UP TO 5X MORE DURABLE



1680D Ballistic Nylon

Model #	Description
48-22-8210	Jobsite Tech Bag

JOBSITE COOLER

HOLDS ICE UP TO 24HRS



2x the Insulation

Model #	Description
48-22-8250	Jobsite Cooler

LOW-PROFILE BACKPACK

**DURABLE,
LOW-PROFILE DESIGN**



1680D Ballistic Nylon

Model #	Description	Pockets
48-22-8202	Low-Profile Backpack	22

JOBSITE BACKPACK

UP TO **5X MORE DURABLE**



Impact-Resistant Base

Model #	Description	Pockets
48-22-8200	Jobsite Backpack	35

ULTIMATE JOBSITE BACKPACK

**ULTIMATE DURABILITY,
PROTECTION, & STORAGE**



Impact-Resistant Base

Model #	Description	Pockets
48-22-8201	Ultimate Jobsite Backpack	48

PARACHUTE ORGANIZER BAG

**FASTEST ACCESS,
BEST CONSTRUCTION**



Stand-Up & Stay-Open Design

Model #	Description
48-22-8170	Parachute Organizer Bag

BUCKET ORGANIZER WRAP

**MOST VERSATILE
BUCKET ORGANIZER**



Exterior Zipper Pockets

Model #	Description
48-22-8175	Bucket Organizer Wrap

ZIPPER POUCHES

UP TO **2X MORE DURABLE**



Water Resistant Stand-Up Base

Model #	Description
48-22-8180	Zipper Pouch
48-22-8193	3 Pc Zipper Pouches
48-22-8183	3 Pc Multi-Size Zipper Pouches

JOBSITE ORGANIZER

**MOST VERSATILE
JOBSITE ORGANIZER**

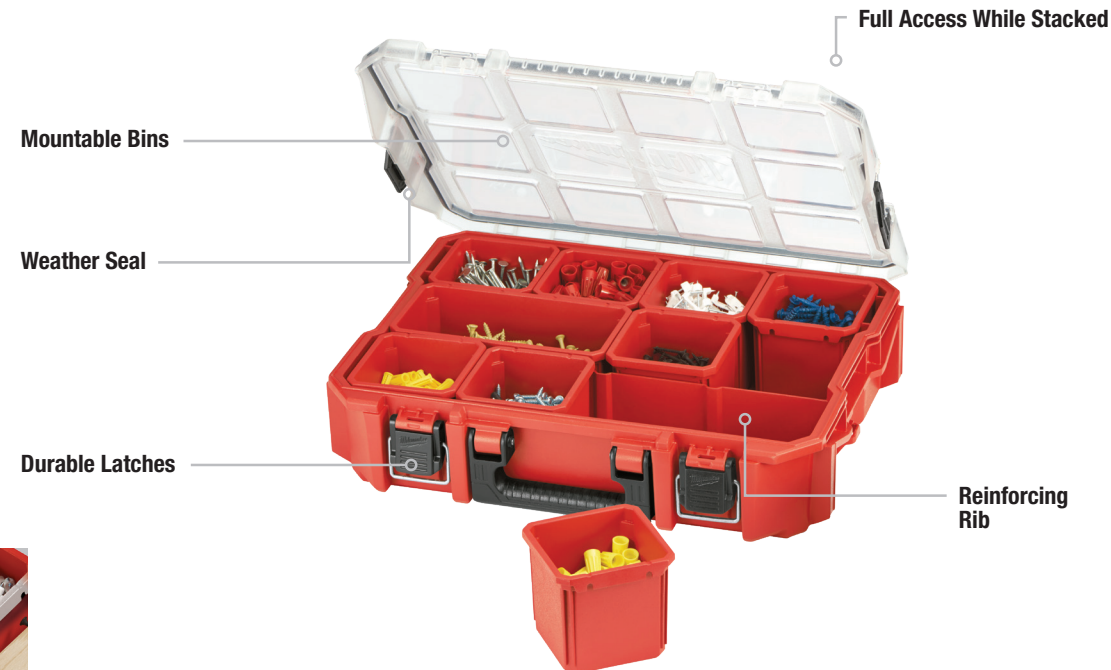

No-Travel Bin Seals

Model #	Description
48-22-8030	20" Jobsite Organizer

WORK BELTS & POUCHES

UP TO **5X LONGER LIFE**



Model #	Description
48-22-8100	Electrician's Work Belt with Quick-Adjust Belt
48-22-8110	Electrician's Work Belt
48-22-8111	Compact Electrician's Work Pouch
48-22-8120	Contractor's Work Belt with Suspension Rig
48-22-8121	Carpenter's Work Pouch
48-22-8122	3-Tier Material Work Pouch

Electrician's Work Belt
48-22-8110

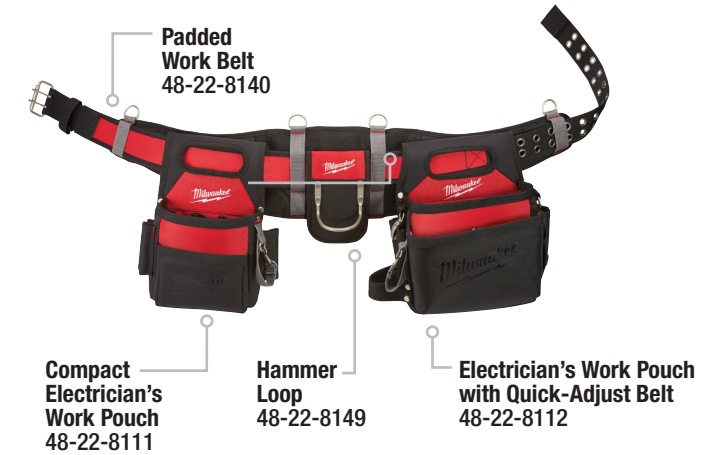

Model #	Description
48-22-8140	Padded Work Belt
48-22-8145	Padded Rig
48-22-8146	XL Padded Rig
48-22-8149	Hammer Loop
48-22-8112	Electrician's Work Pouch with Quick-Adjust Belt

COMPACT UTILITY POUCH

UP TO **5X LONGER LIFE**



Model #	Description
48-22-8118	Compact Utility Pouch

UTILITY POUCH



Model #	Description
48-22-8119	Utility Pouch

DEMOLITION GLOVES WITH SMARTSWIPE™

UP TO **5X LONGER LIFE**



Touch Screen Compatible Knuckle

Model #	Description
48-22-8735	Demolition Gloves S
48-22-8731	Demolition Gloves M
48-22-8732	Demolition Gloves L

Model #	Description
48-22-8733	Demolition Gloves XL
48-22-8734	Demolition Gloves XXL

PERFORMANCE GLOVES WITH SMARTSWIPE™

ULTIMATE DURABILITY. ALL-DAY COMFORT.



Touch Screen Compatible Fingertips, Palm & Knuckle

Model #	Description
48-22-8725	Performance Gloves S
48-22-8721	Performance Gloves M
48-22-8722	Performance Gloves L
48-22-8723	Performance Gloves XL
48-22-8724	Performance Gloves XXL

Model #	Description
48-22-8745	Performance Fingerless Gloves S
48-22-8741	Performance Fingerless Gloves M
48-22-8742	Performance Fingerless Gloves L
48-22-8743	Performance Fingerless Gloves XL
48-22-8744	Performance Fingerless Gloves XXL

FREE-FLEX GLOVES WITH SMARTSWIPE™

ULTIMATE DURABILITY. ALL-DAY COMFORT.



Touch Screen Compatible Fingertips, Palm & Knuckle

Model #	Description
48-22-8715	Free-Flex Gloves S
48-22-8711	Free-Flex Gloves M
48-22-8712	Free-Flex Gloves L

Model #	Description
48-22-8713	Free-Flex Gloves XL
48-22-8714	Free-Flex Gloves XXL

CUT LEVEL 1 DIPPED GLOVES WITH SMARTSWIPE™

ULTIMATE DURABILITY. ALL-DAY COMFORT.



Size	1 Pair	12 Pair (Contractor Pack)
S	48-22-8900	48-22-8900B
M	48-22-8901	48-22-8901B
L	48-22-8902	48-22-8902B

Size	1 Pair	12 Pair (Contractor Pack)
XL	48-22-8903	48-22-8903B
XXL	48-22-8904	48-22-8904B

CUT LEVEL 3 DIPPED GLOVES WITH SMARTSWIPE™

ULTIMATE DURABILITY. ALL-DAY COMFORT.



Size	1 Pair	12 Pair (Contractor Pack)
S	48-22-8930	48-22-8930B
M	48-22-8931	48-22-8931B
L	48-22-8932	48-22-8932B

Size	1 Pair	12 Pair (Contractor Pack)
XL	48-22-8933	48-22-8933B
XXL	48-22-8934	48-22-8934B

CUT LEVEL 5 DIPPED GLOVES WITH SMARTSWIPE™

ULTIMATE DURABILITY. ALL-DAY COMFORT.



Size	1 Pair	12 Pair (Contractor Pack)
S	48-22-8950	48-22-8950B
M	48-22-8951	48-22-8951B
L	48-22-8952	48-22-8952B

Size	1 Pair	12 Pair (Contractor Pack)
XL	48-22-8953	48-22-8953B
XXL	48-22-8954	48-22-8954

CUT LEVEL 1 INSULATED WINTER GLOVES

**ULTIMATE WARMTH.
ALL-DAY COMFORT.**



Size	1 Pair	12 Pair (Contractor Pack)
S	48-22-8910	48-22-8910B
M	48-22-8911	48-22-8911B
L	48-22-8912	48-22-8912B

Size	1 Pair	12 Pair (Contractor Pack)
XL	48-22-8913	48-22-8913B
XXL	48-22-8914	48-22-8914B

CUT LEVEL 3 INSULATED WINTER GLOVES

**ULTIMATE WARMTH.
ALL-DAY COMFORT.**



Size	1 Pair	12 Pair (Contractor Pack)
S	48-22-8920	48-22-8920B
M	48-22-8921	48-22-8921B
L	48-22-8922	48-22-8922B

Size	1 Pair	12 Pair (Contractor Pack)
XL	48-22-8923	48-22-8923B
XXL	48-22-8924	48-22-8924B

LOCKING LANYARDS

**BEST SHOCK
ABSORPTION™**



Double Locking Carabiner

Model #	Description
48-22-8810	10 lbs Locking Tool Lanyard
48-22-8811	10 lbs Extended Reach Locking Tool Lanyard
48-22-8815	15 lb Locking Tool Lanyard
48-22-8850	35 lbs Locking Tool Lanyard

QUICK-CONNECT LOCKING TOOL LANYARD SYSTEM

**BEST SHOCK
ABSORPTION™**

**QUICK-CONNECT
LANYARD SYSTEM**



Quick Tool Change Out

Model #	Description
48-22-8820	10 lbs Quick-Connect Locking Tool Lanyard
48-22-8823	3 Pc 10 lbs Quick-Connect Lanyard Accessory
48-22-8822	3 Pc 5 lbs Quick-Connect Lanyard Accessory

TAPE & D-RING WEB ATTACHMENTS

EASILY CONNECT



48-22-8860



48-22-8870



48-22-8871



48-22-8872



Model #	Description
48-22-8860	12' Self-Adhering Tape
48-22-8870	5 Pc 2 lbs D-Ring Web Attachment
48-22-8871	5 Pc 5 lbs D-Ring Web Attachment
48-22-8872	35 lbs D-Ring Web Attachment

SPLIT RINGS

EASILY CONNECT

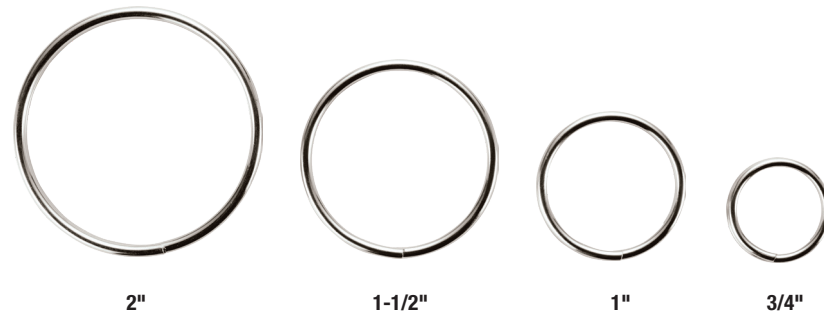

2"

1-1/2"

1"

3/4"



Model #	Description
48-22-8880	5 Pc 2 lbs 3/4" Split Ring
48-22-8881	5 Pc 2 lbs 1" Split Ring
48-22-8882	5 Pc 2 lbs 1-1/2" Split Ring
48-22-8883	5 Pc 2 lbs 2" Split Ring

- 2 TAPE MEASURES
- 4 LONG TAPES & MEASURING WHEELS
- 5 REDSTICK™ LEVELS
- 6 CONCRETE LEVELS & TORPEDO LEVELS
- 7 LASER DISTANCE METERS, CHALK REELS & FOLDING RULES
- 8 INKZALL™ JOBSITE MARKERS
- 9 INKZALL™ PAINT MARKERS, PENS & HIGHLIGHTERS
- 10 FASTENING PLIERS
- 11 FASTENING & CUTTING PLIERS
- 12 CUTTING PLIERS
- 13 COMBINATION & MULTI-FUNCTION PLIERS
- 14 APPLICATION SPECIFIC PLIERS
- 15 TORQUE LOCK™ PLIERS, C-CLAMPS & SPECIALTY
- 16 PIPE WRENCHES
- 18 ADJUSTABLE & BASIN WRENCHES
- 19 RATCHET & SOCKET SETS
- 20 COMBINATION WRENCHES & PRY BARS
- 21 HOOK AND PICK SET & MULTI-BIT DRIVERS
- 22 MULTI-BIT DRIVERS & SCREWDRIVERS
- 23 SCREWDRIVERS
- 25 NUT DRIVERS
- 26 HAMMERS & HAND CLAMPS
- 27 FIXED BLADE & POCKET KNIVES
- 28 POCKET KNIVES
- 29 UTILITY KNIVES
- 32 INSULATION & DUCT KNIVES
- 33 AVIATION SNIPS
- 34 TINNERS SNIPS
- 35 SCISSORS, SEAMER & CRIMPER
- 36 BOLT CUTTERS
- 37 HACKSAWS
- 38 SAWS
- 39 TUBING/PIPE CUTTERS & REAMING PEN
- 40 COPPER TUBING CUTTERS
- 42 LOW VOLTAGE VDV
- 44 PACKOUT™ MODULAR STORAGE
- 48 BAGS
- 49 COOLERS & BACKPACKS
- 50 BACKPACKS
- 52 ORGANIZERS
- 53 WORK BELTS & POUCHES
- 54 WORK GLOVES
- 55 DIPPED GLOVES
- 56 INSULATED WINTER GLOVES
- 57 LANYARD ACCESSORIES



MILWAUKEE TOOL
13135 West Lisbon Road
Brookfield, WI 53005

milwaukeetool.com

