

**ASSORTED TOOLS**

**B = Bulk  
C = Carded  
P = Poly Bag**

ITEM NO.	PACK	DESCRIPTION	CTN. QTY.
----------	------	-------------	-----------

**SEAT RE - SEATERS / GRINDER**

13-1056	C	#31 Long shaft Seat dresser 4 Cutters • Guide cone	12
13-1065	C	Lasco Reseater / Seat dresser 3 Cutters • Guide Cone • 6 Washers and 2 Screws	6

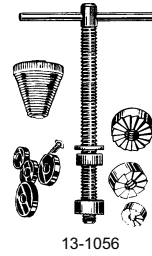

13-1056

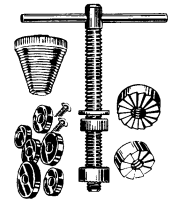

13-1065

**O-RING PICK**

13-1061	C	Lasco O-Ring pick	6
---------	---	-------------------	---

**LEAD LADLES AND POTS**

13-1850	B	3" Ladle	1
13-1852	B	4" Ladle	1
13-1854	B	5" Ladle	1
13-1860	B	5" Pot	1
13-1862	B	6" Pot	1
13-1864	B	8" Pot	1

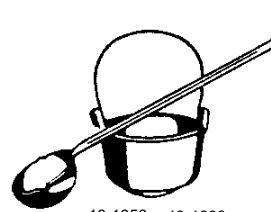

13-1850 13-1860  
13-1852 13-1862  
13-1854 13-1864

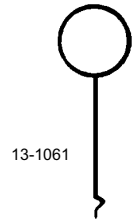

13-1061

**MATCH HOLDER**

13-1950	B	Match holder extender (Extends 6" to 25")	25
---------	---	---	----

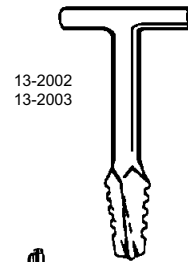

13-2002  
13-2003



13-2008

**NIPPLE EXTRACTORS**

13-2002	B	1/2" Honey Bee PVC Extractor	25
13-2003	C	Same as above carded	6
13-2008	C	1/2 or 3/4 Combo Nipple Extractor Set	12
13-2009	C	Same as above carded	6
13-2300	B	3/8" Cam Type Nipple Extractor	25
13-2301	C	Same as above carded	6
13-2302	B	1/2" Cam Type Nipple Extractor	25
13-2303	C	Same as above carded	6
13-2304	B	3/4" Cam Type Nipple Extractor	25
13-2305	C	Same as above carded	6
13-2306	B	1" Cam Type Nipple Extractor	25
13-2307	C	Same as above carded	6
13-2308	B	#6 Spiral Extractor • Moen Cartridge	5
13-2309	C	Same as above carded	6
13-2310	B	1/2" Spiral Type Nipple Extractor	5
13-2311	C	Same as above carded	6
13-2312	B	3/4" Spiral Type Nipple Extractor	5
13-2313	C	Same as above carded	6
13-2314	C	1/2" Internal Nipple Extractor	1



13-1950

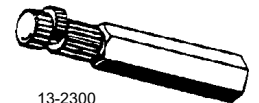

13-2300  
thru  
13-2307



13-2308  
thru  
13-2313

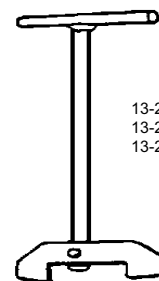

13-2004  
13-2004P  
13-2005



13-2314

**DISPOSAL TOOL**

13-2004	B	Garbage Disposal Free All Tool	12
13-2005	C	Same as above carded	6



**ASSORTED TOOLS**

**B = Bulk**  
**C = Carded**  
**P = Poly Bag**

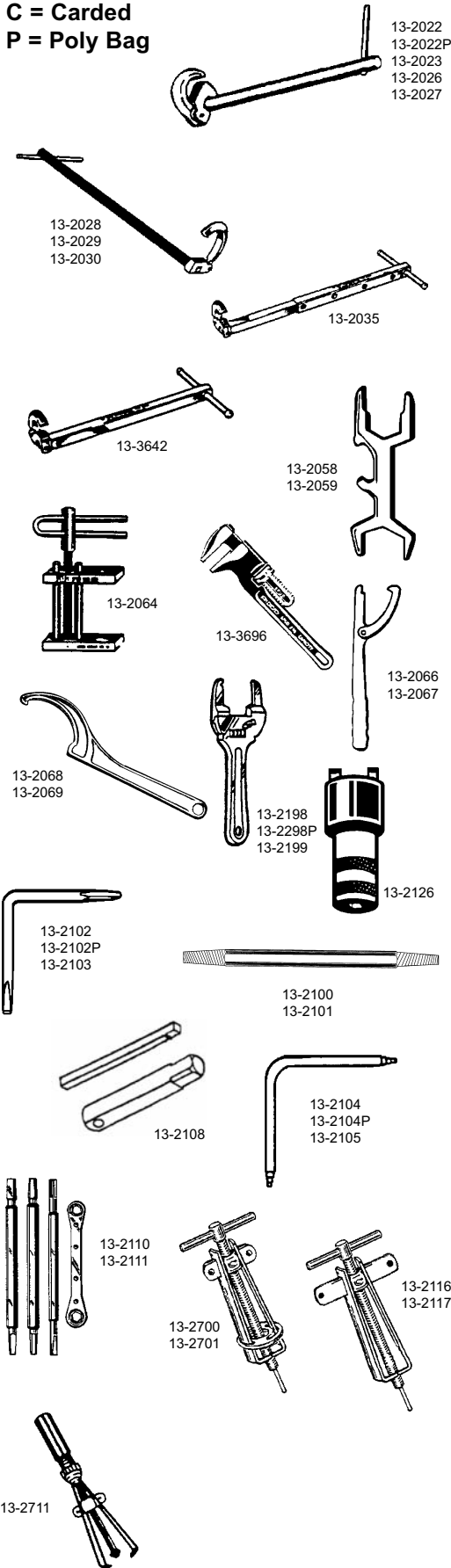

ITEM NO.	PACK	DESCRIPTION	CTN. QTY.
----------	------	-------------	-----------

**BASIN WRENCHES**

13-2022	B	11" Spring Loaded Basin Wrench	24
13-2022P	P	Same as above Poly Bag	12
13-2023	C	Same as above carded	6
13-2026	B	16" Spring Loaded Basin Wrench	24
13-2027	C	Same as above carded	6
13-2029	C	Large Jaw Basin Wrench	6
13-2035	C	Telescopic Basin Wrench Adjustable 9" to 16"	6
13-3642	B	"Ridgid" #1017 Long Handle Basin Wrench	1

**SPUD WRENCHES**

13-2058	B	4 in 1 Spud Wrench	12
13-2059	C	Same as above carded	6
13-2064	B	Internal Spud Wrench Adjustable from 1" to 4"	1
13-3696	B	"Ridgid" #3140 Spud Wrench	1

**LOCK NUT WRENCHES**

13-2066	B	Hinged Jaw for Removal of Basket Strainer Nut	12
13-2067	C	Same as above carded	6
13-2068	B	JT Basket Strainer Wrench	12
13-2069	C	Same as above carded	6
13-2126	B	The "NUTCRACKER" Quickly Removes old 1/2" zinc faucet nuts	6
13-2198	B	Adjustable Lock Nut Wrench • 1" to 3"	12
13-2198P	P	Same as above Poly Bag	12
13-2199	C	Same as above carded	6

**SEAT WRENCHES**

13-2100	B	Threaded/Tapered Straight Wrench	25
13-2101	C	Same as above carded	6
13-2102	B	Tapered Angle Seat Wrench	25
13-2102P	P	Same as above Poly Bag	12
13-2103	C	Same as above carded	6
13-2104	B	6-Step Angle Seat Wrench	25
13-2104P	P	Same as above Poly Bag	12
13-2105	C	Same as above carded	6
13-2110	B	4 Piece Seat Wrench Set	1
13-2111	C	3-Straight wrenches and 1 ratchet	6
13-2108	B	Symmons Seat Tool	1

**HANDLE PULLERS**

13-2701	C	Standard Handle Puller	6
13-2711	C	Heavy Duty • Hammer Style Puller	6
13-2116	B	Large Capacity Handle Puller	12
13-2117	C	Same as above carded	6



ASSORTED TOOLS

B = Bulk  
C = Carded  
P = Poly Bag

ITEM NO.	PACK	DESCRIPTION	CTN. QTY.
<b>SLEEVE PULLER</b>			
13-2128	B	Tool to Remove Ferrule / Sleeve From Copper Pipe • (Use with handle puller)	12
13-2129	C	Same as above carded	6
13-2704	B	Professional sleeve puller works with fine or coarse thread nuts	10
13-2707	C	Compression sleeve puller with handle puller	6
13-2706	B	PASCO 1/2" Compression Sleeve Puller	5
13-2708	B	PASCO HD Compression Sleeve Puller	1
<b>MOEN CARTRIDGE PULLERS</b>			
13-2120	B	#13705 Moen Genuine	1
13-2122	B	The "ONA" Puller • Simply the best	1
13-2122-1	B	Replacement stem for "ONA" Puller	1
13-2124	B	Basic Moen Puller	12
13-2125	C	Same as above carded	6
13-2132	B	Lasco Moen Puller	12
13-2133	C	Same as above carded	6
<b>TORQUE WRENCH</b>			
13-2130	B	No Hub Torque Wrench	12
<b>STRAINER WRENCHES</b>			
13-2118	B	The "SMART" Dumbbell To remove tub drain strainers	6
13-2119	C	Same as above carded	6
13-2204	B	P.O. Plug Wrench	12
13-2205	C	Same as above carded	6
13-2208	B	Strainer Wrench	12
13-2209	C	Same as above carded	6
<b>SOCKET SETS AND SOCKETS ONLY</b>			
13-2316	B	5 Piece Socket Set with Handle	12
13-2316P	P	Same as above Poly Bag	12
13-2317	C	Same as above carded	6
13-2330	B	21/32 x 27/32 Socket Only	12
13-2331	C	Same as above carded	6
13-2332	B	29/32 x 31/32 Socket Only	12
13-2333	C	Same as above carded	6
13-2334	B	1-1/32 x 1-3/32 Socket Only	12
13-2335	C	Same as above carded	6
13-2336	B	1-5/32 x 1-9/32 Socket Only	12
13-2337	C	Same as above carded	6
13-2338	B	1-11/32 x 1-7/16 Socket Only	12
13-2339	C	Same as above carded	6
13-2408	B	Price Pfister • 27/32 x 31/32 27/32 x 31/32 • Heavy Duty	12
13-2409	C	Same as above carded	6
13-2400	B	American Standard • For Colony Stems	12
13-2402	B	Indiana Brass Wrench	12
13-2404	B	Kohler Shoreham Wrench	12

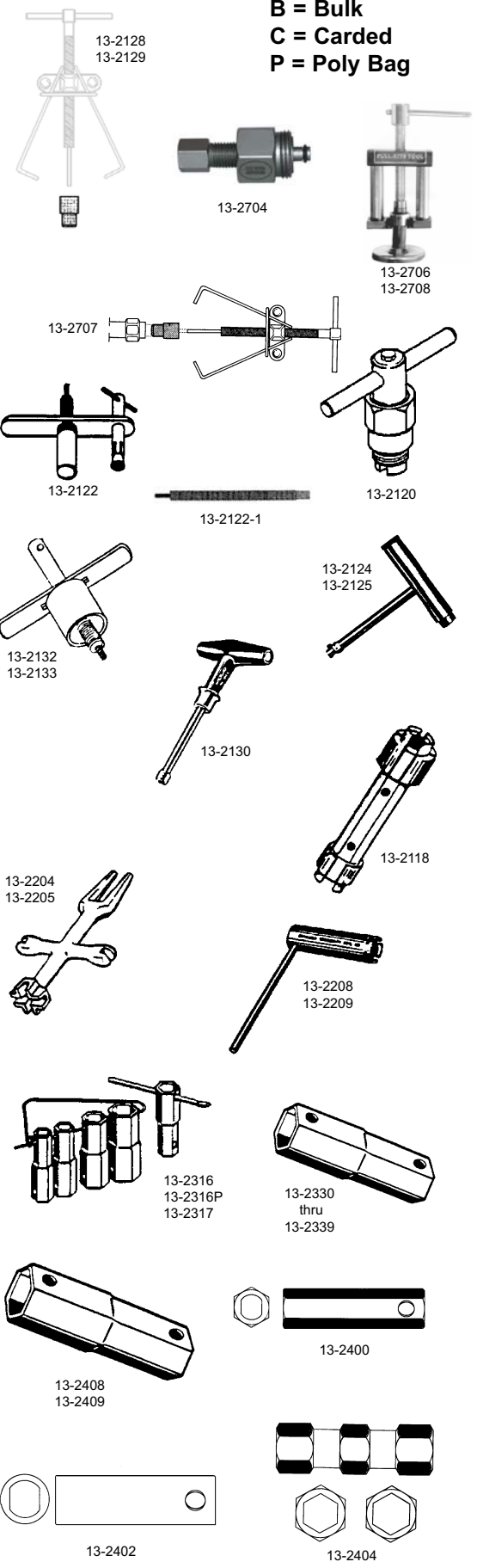

**B = Bulk**  
**C = Carded**

**ASSORTED TOOLS**

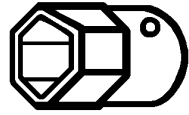

40-1600  
40-1601

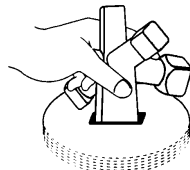

13-2412

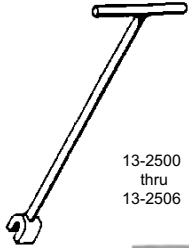

13-2500  
thru  
13-2506

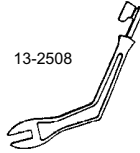

13-2508

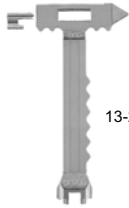

13-2510

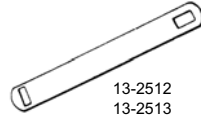

13-2512  
13-2513

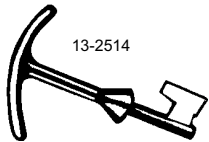

13-2514

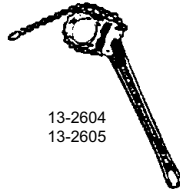

13-2604  
13-2605



13-2602  
13-2603

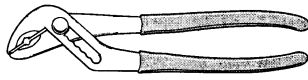

13-2650



13-2660



13-2752 13-2762



13-2610  
13-2612

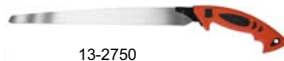

13-2750



13-2760

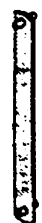

13-2734  
13-2735



13-2732  
13-2733



13-2739

ITEM NO.	PACK	DESCRIPTION	CTN. QTY.
----------	------	-------------	-----------

**WATER HEATER ELEMENT WRENCH**

40-1600	B	Water Heater Element Wrench	12
40-1601	C	Same as above carded	6

**DRUM WRENCH**

13-2412	B	Drum Trap Wrench	12
---------	---	------------------	----

**UTILITY METER WRENCH**

13-2500	B	Light Pattern Water Meter • 1/2" x 26"	5
13-2502	B	Regular Pattern Water Meter • 3/4" x 26"	5
13-2504	B	Heavy Duty Pattern • 1" x 38"	5
13-2506	B	Long Pattern • 3/4" x 60"	1
13-2508	B	Brass Combo Meter / Box Key	12
13-2514	B	Water Meter Box Key	12
13-2510	B	Emergency Gas/Water Shut-Off	12
13-2512	B	Emergency Gas Shut-Off Wrench	12
13-2513	C	Same as above carded	6

**STRAP WRENCHES**

13-2603	C	Strap Wrench • 2" Capacity • 7" Long	6
13-2604	B	Chain Wrench • 1" - 3" Capacity	12
13-2605	C	Same as above carded	6
13-2610	B	BOA Strap Wrench • Rubber Strap • 4" Capacity • 6" Long	12
13-2612	B	BOA Strap Wrench • Rubber Strap • 6" Capacity • 8" Long	12
13-2650	B	Smooth - Jaw Pliers • Nylon Grippers	6

**ANGLE STOP WRENCHES**

13-2660	B	PASCO Rapid Angle Stop Wrench Kit	1
---------	---	-----------------------------------	---

**HAND SAWS**

13-2750	B	12" Push Pull Hand Saw	1
13-2752	B	12" Blade for Push Pull Hand Saw	1
13-2760	B	8" Push Pull Hand Saw	5
13-2762	B	8" Blade for Push Pull Hand Saw	1

**SAWS**

13-2732	B	Mini Hacksaw • Cuts wood, plaster, steel, brass, ect.	10
13-2733	C	Same as above carded	6
13-2734	B	Mini Hacksaw Replacement Blade	10
13-2735	C	Same as above carded (2per card)	6
13-2739	C	PVC Cable Saw • 24" Steel Cutting Cable	6



**ASSORTED TOOLS**

**B = Bulk  
C = Carded  
P = Poly Bag**

ITEM NO.	PACK	DESCRIPTION	CTN. QTY.
----------	------	-------------	-----------

**FLARING TOOLS**

13-2800	B	Professional Flaring Tool • 3/16" - 5/8"	12
13-2801	C	Same as above carded	6
13-2806P	P	Lasco Flaring Tool	12
13-2807	C	Same as above carded	6
13-4230	B	Ridgid #458R Ratchet Flare Tool • 1/8" - 3/4"	1

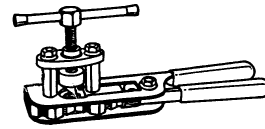

13-2800  
13-2801

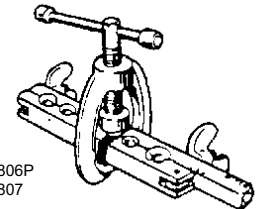

13-2806P  
13-2807

**SPRING TUBE BENDERS**

13-2860	B	1/4" Spring Tube Bender	12
13-2861	C	Same as above carded	6
13-2862	B	5/16" Spring Tube Bender	12
13-2863	C	Same as above carded	6
13-2864	B	3/8" Spring Tube Bender	12
13-2865	C	Same as above carded	6
13-2866	B	7/16" Spring Tube Bender	12
13-2867	C	Same as above carded	6
13-2868	B	1/2" Spring Tube Bender	12
13-2869	C	Same as above carded	6
13-2870	B	5/8" Spring Tube Bender	12
13-2871	C	Same as above carded	6
13-2880	B	Tube Bender 3/16" - 3/8"	1



13-4230

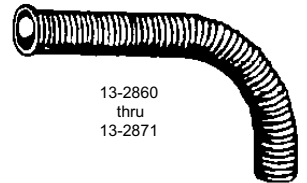

13-2860  
thru  
13-2871

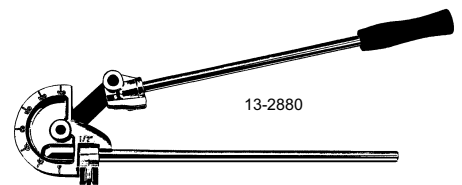

13-2880

**FOUR WAY KEYS**

01-5223	C	All Square Broaches 1/4", 9/32", 5/16", 11/32"	6
01-5227	C	Combo Broach Tool 3 Round Broaches • 1 Square • Hand or Socket Drive	6

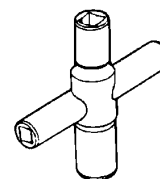

01-5223

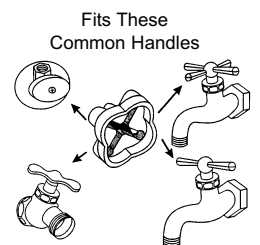

01-5227

Fits These  
Common Handles



**CUTTERS**

**B = Bulk**  
**C = Carded**  
**P = Poly Bag**

ITEM NO.	PACK	DESCRIPTION	CTN. QTY.
----------	------	-------------	-----------

**MINI TUBING CUTTERS**

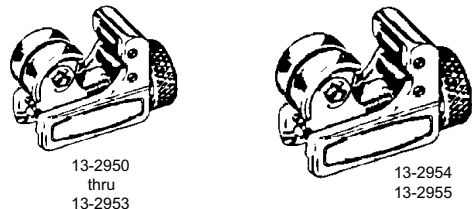

13-2950	B	1/8" to 5/8"	12
13-2950P	P	Same as above Poly Bag	12
13-2951	C	Same as above carded	6
13-2952	B	1/8" to 7/8"	12
13-2953	C	Same as above carded	6
13-2954	B	1/8" to 1-1/8"	12
13-2955	C	Same as above carded	6

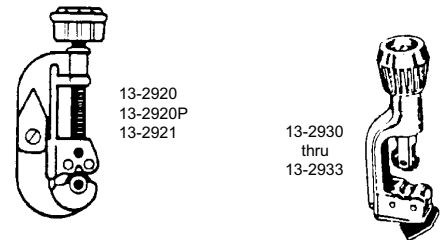

**REGULAR TUBING CUTTERS**

13-2920	B	1/8" to 1-1/8" with reamer	12
13-2920P	P	Same as above Poly Bag	12
13-2921	C	Same as above carded	6
13-2930	B	1/8" to 1-1/8" Precision Cutter (Double Rollers)	12
13-2931	C	Same as above carded	6
13-2932	B	1/4" to 1-5/8" Precision Cutter (Double Rollers)	12
13-2933	C	Same as above carded	6
13-2940	B	1/4" to 2-1/2" Zip Action	12
13-2941	C	Same as above carded	6

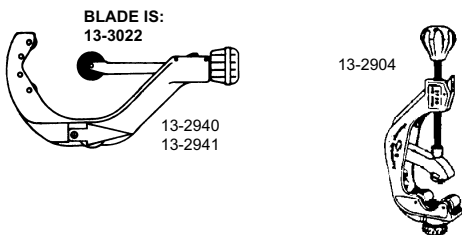

13-2904	B	Chicago #3720 1" to 3-1/8" Zip Action	12
13-2970	B	Superior #35218 1/8" to 1-1/8"	12
13-2922	B	Superior #ST2000 Pipe and Tubing Cutter Cuts pipe 3/8" to 1" • Tube 5/8" to 2-1/8"	12

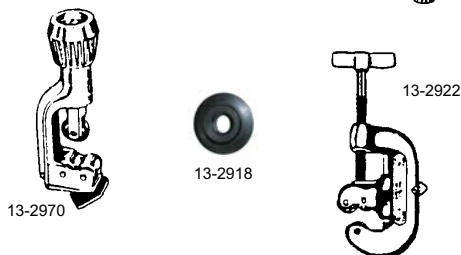

**GENERAL WIRE TUBING CUTTERS**

13-2910	C	1/2" Autocut for Close Quarters	12
13-2912	C	3/4" Autocut for Close Quarters	12
13-2914	C	1/2" Autocut Ratchet Handle Only	8
13-2916	C	3/4" Autocut Ratchet Handle Only	8
13-2918	C	1/2" - 3/4" Cutter Wheel	1

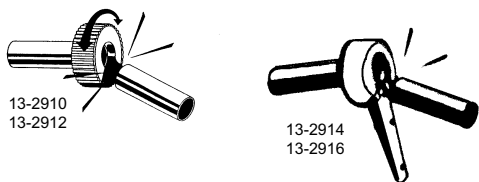

**RIDGID TUBING CUTTERS**

**RIDGID**

13-4076	B	#103 Mini Cutter 1/8" to 5/8"	1
13-4078	B	#104 Mini Cutter 1/8" to 15/16"	1
13-4080	B	#150 Telescoping Cutter 1/8" to 1-1/8"	1
13-4082	B	#205 Telescoping Cutter 1/4" to 2-3/8"	1
13-4084	B	#10 Standard Cutter 1/8" to 1"	1
13-4086	B	#15 Standard Cutter 3/16" to 1-1/8"	1



**RIDGID PIPE CUTTERS**

**RIDGID**

13-4100	B	#1A Cutter 1/8" to 1-1/4"	1
13-4102	B	#2A Cutter 1/8" to 2"	1

**LASCO PIPE CUTTERS**

13-2946	B	Lasco Cutter 1/8" to 2"	1
---------	---	-------------------------	---

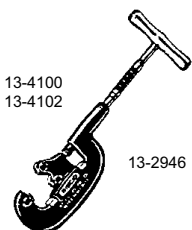

**CUTTER WHEELS**

**B = Bulk  
C = Carded**

ITEM NO.	PACK	DESCRIPTION	CTN. QTY.
----------	------	-------------	-----------

**CUTTER WHEELS**

13-3010	B	11/16 OD x 3/16 ID x 1/8 Thick For mini and #105, #205 Ridgid	12
13-3011	C	Same as above carded (2 per card)	6
13-3012	B	11/16 OD x 3/16 ID x 1/4 Thick For 13-2921 & #10, #15, #20 Ridgid	12
13-3013	C	Same as above carded (2 per card)	6
13-3000	B	1 OD x 5/16 ID x 7/16 Thick For #3720 Chicago, #30, #40 Ridgid	12
13-3001	C	Same as above carded (1 per card)	6
13-3014	B	1-1/4 OD x 5/16 ID x 7/16 Thick For 1A, 2A Ridgid pipe cutter	12
13-3015	C	Same as above carded (1 per card)	6
13-3020	C	Superior for #300 (Same as 13-3012)	12
13-3022	B	Superior for #ST2000 15/16 OD x 1/4 ID x 5/16 Thick	12
13-2918	B	Auto Cut Cutter Wheel	12
13-3006	B	Pin for 13-2951	12
13-3007	C	Same as above carded	6
13-3008	B	Pin for 13-2921	12
13-3009	C	Same as above carded	6

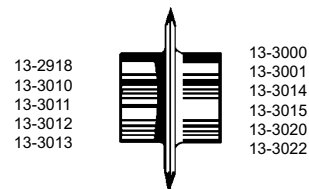

**RIDGID CUTTER WHEELS**

13-4000	B	E-1032 1-1/2 OD x 11/32 ID x 3/4 Thick For #820, #360 Cutters	1
13-4002	B	E-2191 1-5/32 OD x 5/16 ID x 7/16 Thick For #107, #136, #136P Cutters	1
13-4004	B	F-3 1-1/4 OD x 11/32 ID x 3/4 Thick For #1A, #2A, #42A, #202 (Heavy Duty)	1
13-4006	B	Same as above (Standard Duty)	1
13-4020	B	E-1240 3/4 OD x 3/16 ID x 1/4 Thick For #10, #15, #20 Cutters (Heavy Duty)	1
13-4030	B	F-158 3/4 OD x 3/16 ID x 1/4 Thick For #10, #15, #20 Cutter (Standard)	1
13-4022	B	E-2558 1 OD x 5/16 ID x 7/16 Thick For #30, #40, #106, #133, #134, #136 Cutters	1
13-4024	B	E-2990 11/16 OD x 3/16 ID x 1/4 Thick For #315 Cutter	1
13-4026	B	E-3469 3/4 OD x 3/16 ID x 1/8 Thick For #103, #104, #105, #132, #205 Cutter (Std.)	1
13-4028	B	E-4546 Same as above (Heavy Duty)	1

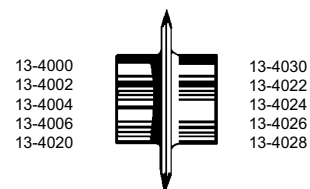

ASSORTED TOOLS

B = Bulk  
C = Carded  
P = Poly Bag

ITEM NO.	PACK	DESCRIPTION	CTN. QTY.
----------	------	-------------	-----------

PLASTIC PIPE CUTTERS

13-2986	B	Click cut for vinyl tubing 1/8" - 5/8"	10
13-2987	C	Same as above carded	6
13-2989	C	Quick cut for vinyl and rubber tubing	6
13-2983	C	PVC pipe cutter • 1/2" to 3/4" pipe	6
13-2980P	P	Same as above Poly Bag	12
13-2981	C	PVC pipe cutter • 1/2" to 1" pipe	6
13-2985	C	1/2 - 1-5/8" • Side cut • PVC pipe cutter	1
13-2992	C	1/2" - 1" Pro cutter with Jar opener	5
13-2976	B	Heavy Duty cutter • 1/2" to 1"	12
13-2978	B	Heavy Duty cutter • 1-1/4" to 1-1/2"	5
13-2990	C	General Wire PVC pipe cutter 1/2" to 3/4"	10
13-2996	C	Inside PVC and ABS pipe cutter	6
13-2974	C	1/2" - 2" OD Pro cutter	6

REPLACEMENT BLADES

13-4044	B	Blade for 13-2981 • 1/2" to 1" • Taiwan	12
13-4045	C	Same as above carded	6
13-4046	B	Blade for 13-2981 • 1/2" to 1" • China	12
13-4047	C	Same as above carded	6
13-4048	B	Blade for 13-2983 • 1/2" to 3/4" pipe	1
13-4050	B	Blade for Quick Cutter	1
13-4052	B	Blade for Side Cutter	1
13-3038	B	Blade for 13-2976 • 1/2" to 1" • Victor	1
13-3036	B	Blade for 13-2978 • 1-1/4" to 1-1/2" • Victor	1
13-3034	B	Blade for 13-2978 • 1-1/4" to 1-1/2" • Taiwan	1
13-3032	B	Blade for 13-2985 • 1-1/4" to 1-1/2"	1

COPPER DEBURRING TOOL

13-3236	B	Deburs up to 1-1/4" pipe	1
13-3237	C	Same as above carded	6
13-3238	B	Deburring tool for Copper & Aluminum	10
13-3239	C	Same as above carded	6

PIPE TAPS • CARBON STEEL

13-3100	B	1/8" IPS • Drill Size R	5
13-3102	B	1/4" IPS • Drill Size 7/16	5
13-3104	B	3/8" IPS • Drill Size 37/64	5
13-3106	B	1/2" IPS • Drill Size 45/64	5
13-3107	C	Same as above carded	6
13-3108	B	3/4" IPS • Drill Size 59/64	5
13-3109	C	Same as above carded	6
13-3110	C	1" IPS • Drill Size 1-5/32	5
13-3112	B	1-1/4" IPS • Drill Size 1-1/2	5
13-3114	B	1-1/2" IPS • Drill Size 1-47/64	5
13-3116	B	2" IPS • Drill Size 2-7/32	5

THREAD CHASERS

13-3150	B	1/2" IPS x 20 Thread	5
13-3152	B	3/4" IPS x 16 Thread	5

LASCO ABRASIVE CLOTH

13-3240	B	1-1/2" x 5 Yard • 180 Grit open mesh Sandcloth	10
13-3243	C	1-1/2" x 72" • 120 Grit EZ-Clean Sandcloth	6
13-3244	B	1-1/2" x 10 Yard • 120 Grit EZ-Clean Sandcloth	24

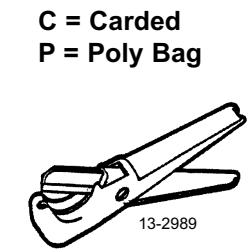

13-2983  
13-2980P  
13-2974

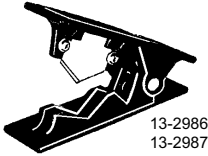
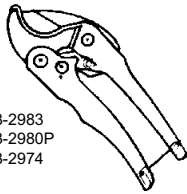

13-2986  
13-2987

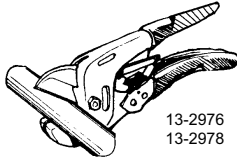

13-2976  
13-2978

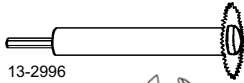

13-2996

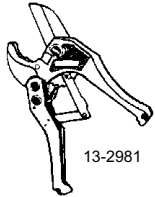

13-2981



13-4044  
13-4045



13-2992

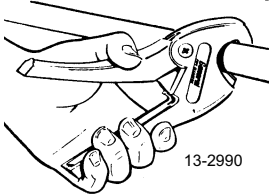

13-2990



13-3038  
13-3036

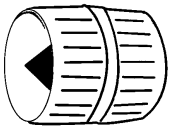

13-3236  
13-3237

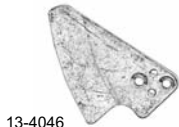

13-4046  
13-4047

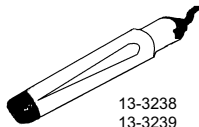

13-3238  
13-3239

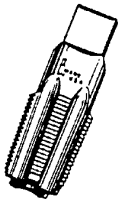

13-3100  
thru  
13-3116



13-3150  
13-3152



13-3240

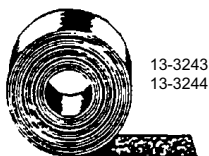

13-3243  
13-3244





**ASSORTED TOOLS**

**B = Bulk  
C = Carded**

ITEM NO.	PACK	DESCRIPTION	CTN. QTY.
----------	------	-------------	-----------

**LASCO TUBING BRUSHES**

13-3200	B	3/8" Inside brush	12
13-3202	B	1/2" Inside brush	12
13-3203	C	Same as above carded	6
13-3204	B	3/4" Inside brush	12
13-3205	C	Same as above carded	6
13-3206	B	1" Inside brush	12
13-3207	C	Same as above carded	6
13-3220	B	3/8" Outside brush	12
13-3222	B	1/2" Outside brush	12
13-3223	C	Same as above carded	6
13-3224	B	3/4" Outside brush	12
13-3225	C	Same as above carded	6
13-3226	B	1" Outside brush	12
13-3227	C	Same as above carded	6
13-3230	B	1/2"-3/4" • Inside and Outside	12
13-3231	C	Same as above carded	6

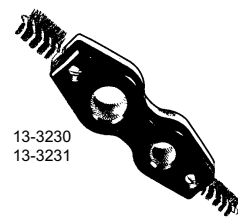
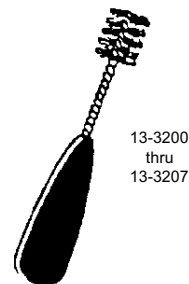

**BRUSHTECT FITTING BRUSHES**

13-3182	B	1/2" Deluxe tee handle brush	12
13-3184	B	3/4" Deluxe tee handle brush	12

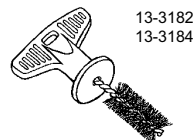

**LASCO ACID BRUSHES**

13-3246	B	#1 Acid brushes	144
13-3247	C	Same as above carded (2 per card)	6
13-3248	B	#2 Acid brushes	144

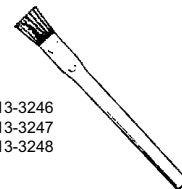

**PIPE WRENCHES IMPORT**

13-3300	B	8" Straight	6
13-3302	B	10" Straight	6
13-3304	B	12" Straight	6
13-3306	B	14" Straight	6
13-3308	B	18" Straight	6
13-3310	B	24" Straight	6

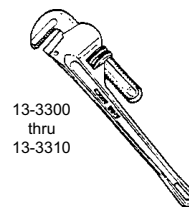

13-3314	B	12" Close Quarter	6
13-3316	B	14" Close Quarter	6

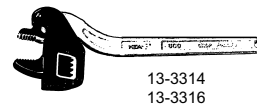

**PIPE WRENCHES**



13-3320	B	6" Straight	6
13-3322	B	8" Straight	6
13-3324	B	10" Straight	6
13-3326	B	12" Straight	6
13-3328	B	14" Straight	6
13-3330	B	18" Straight	6
13-3336	B	48" Straight	1

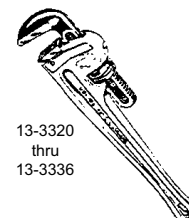
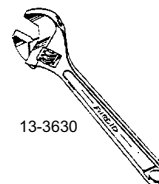

13-3630	B	12" Adjustable Wrench	6
---------	---	-----------------------	---



B = Bulk

RIDGID TOOLS

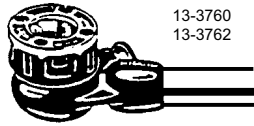

13-3760  
13-3762

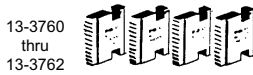

13-3760  
thru  
13-3762



13-3830  
thru  
13-3840

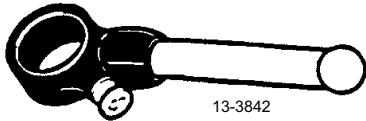

13-3842

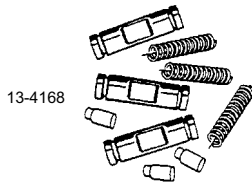

13-4168

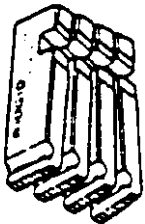

13-4280  
thru  
13-4292

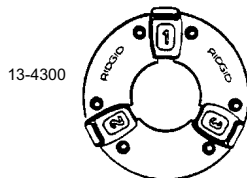

13-4300

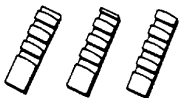

13-4302

ITEM NO.	PACK	DESCRIPTION	CTN. QTY.
----------	------	-------------	-----------

PIPE DIE SETS



13-3760	B	00-R Die Set 1/2" - 3/4"	1
13-3762	B	00-R Die Set 1/2" - 1"	1

PIPE DIE ONLY

13-3800	B	1/8" Dies only (set of 4 per card)	1
13-3802	B	1/4" Dies only (set of 4 per card)	1
13-3804	B	3/8" Dies only (set of 4 per card)	1
13-3806	B	1/2" Dies only (set of 4 per card)	1
13-3808	B	3/4" Dies only (set of 4 per card)	1
13-3810	B	1" Dies only (set of 4 per card)	1
13-3812	B	1-1/4" Dies only (set of 4 per card)	1
13-3814	B	1-1/2" Dies only (set of 4 per card)	1
13-3816	B	2" Dies only (set of 4 per card)	1

\*Above Dies Fits • 0-R, 11-R, 00-R, 111-R, 12-R  
30-A and 31-A Threaders

PIPE DIE HEAD COMPLETE

13-3830	B	1/8" 00-R Die Head Complete	1
13-3832	B	1/4" 00-R Die Head Complete	1
13-3834	B	3/8" 00-R Die Head Complete	1
13-3836	B	1/2" 00-R Die Head Complete	1
13-3838	B	3/4" 00-R Die Head Complete	1
13-3840	B	1" 00-R Die Head Complete	1

RATCHET AND HANDLE

13-3842	B	00-R Ratchet and Handle only	1
---------	---	------------------------------	---

JAW INSERT SET

13-4168	B	E-1666X Jaw Insert Set Springs and Pins • 3 each per set	1
---------	---	---	---

UNIVERSAL DIES SETS

13-4280	B	1/2"-3/4" Alloy Die Set for Universal Head	1
13-4282	B	1"-2" Alloy Die Set for Universal Head	1
13-4284	B	1/2"-3/4" Hi Speed Die Set for Universal Head	1
13-4286	B	1"-2" Hi Speed Die Set for Universal Head	1

HEADS

13-4292	B	554 Quick Opening Dies only	1
13-4300	B	Rear Centering Head	1
13-4302	B	Rear Centering Head Jaw Set	1



GAUGES

ITEM NO.	PACK	DESCRIPTION	CTN. QTY.
----------	------	-------------	-----------

**WATER TEST GAUGES • With Hose Threads**

13-1898	B	Water Test Gauge • 100 PSI	1
13-1900	B	Water Test Gauge • 300 PSI	1
13-1901	C	(Same as above carded)	6

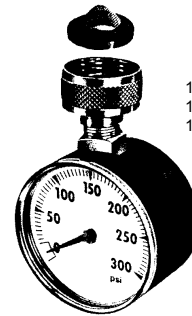

13-1896  
13-1900  
13-1901

**GAS TEST GAUGES • With 3/4" IPS Thread**

13-1892	B	1/10 Incremental • 15 PSI	50
13-1893	C	(Same as above carded)	6
13-1890	B	Gas Test Gauge • 15 PSI	1
13-1891	C	(Same as above carded)	6
13-1902	B	Gas Test Gauge • 30 PSI	1
13-1903	C	(Same as above carded)	6
13-1904	B	Gas Test Gauge • 60 PSI	1
13-1905	C	(Same as above carded)	6
13-1906	B	Gas Test Block • 300 PSI	1
13-1908	B	Replacement valve stem in cap for gas test gauge or block	1

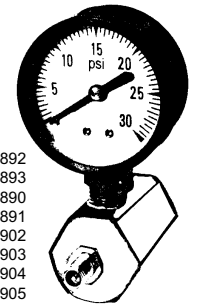

13-1892  
13-1893  
13-1890  
13-1891  
13-1902  
13-1903  
13-1904  
13-1905

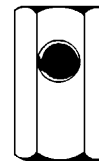

13-1906

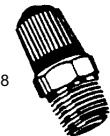

13-1908

**PRESSURE GAUGES • 2 Inch (1/4" Bottom Outlet)**

13-1910	B	Pressure Gauge • 30 PSI	1
13-1911	C	(Same as above carded)	6
13-1912	B	Pressure Gauge • 60 PSI	1
13-1913	C	(Same as above carded)	6
13-1914	B	Pressure Gauge • 100 PSI	1
13-1915	C	(Same as above carded)	6
13-1916	B	Pressure Gauge • 200 PSI	1
13-1917	C	(Same as above carded)	6

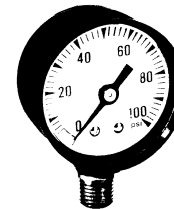

13-1910  
thru  
13-1917

**PRESSURE GAUGES • 2-1/2 Inch (1/4" Bottom Outlet)**

13-1930	B	Pressure Gauge • 30 PSI	1
13-1931	C	(Same as above carded)	6
13-1932	B	Pressure Gauge • 60 PSI	1
13-1933	C	(Same as above carded)	6
13-1934	B	Pressure Gauge • 100 PSI	1
13-1935	C	(Same as above carded)	6
13-1936	B	Pressure Gauge • 200 PSI	1
13-1937	C	(Same as above carded)	6

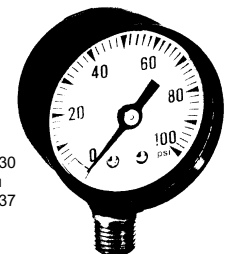

13-1930  
thru  
13-1937

**PRESSURE GAUGES • 1-1/2 Inch (1/8" Back Outlet)**

13-1926	B	Pressure Gauge • 160 PSI	12
13-1927	C	(Same as above carded)	6

**PRESSURE GAUGES • 2 Inch (1/4" Back Outlet)**

13-1946	B	Pressure Gauge • 160 PSI	12
13-1947	C	(Same as above carded)	6

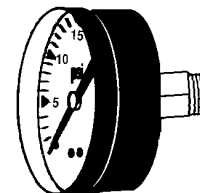

13-1926  
13-1927  
13-1946  
13-1947

**Note:** The above pressure gauges are suitable for oil, water, air, and any gas or liquid that will not corrode steel and are recommended for pumps, compressors, and other hydraulic and pneumatic system machinery.



**B = Bulk**  
**C = Carded**

**REPAIR CLAMPS and UNIONS**

ITEM NO.	PACK	DESCRIPTION	CTN. QTY.
----------	------	-------------	-----------

**PIPE REPAIR CLAMPS**

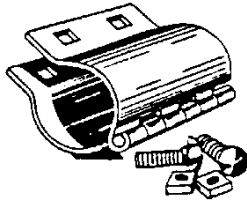

13-1250  
thru  
13-1261

13-1250	B	1/2" Hinged Type	12
13-1251	C	Same as above carded	6
13-1252	B	3/4" Hinged Type	12
13-1253	C	Same as above carded	6
13-1254	B	1" Hinged Type	12
13-1255	C	Same as above carded	6
13-1256	B	1-1/4" Hinged Type	12
13-1257	C	Same as above carded	6
13-1258	B	1-1/2" Hinged Type	12
13-1259	C	Same as above carded	6
13-1260	B	2" Hinged Type	12
13-1261	C	Same as above carded	6

**STAINLESS STEEL 1 PIECE CLAMP 3" • ONE BOLT**

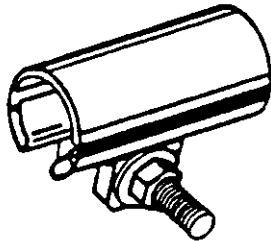

13-1298  
thru  
13-1318

13-1298	B	3/8" IPS or 1/2" Copper	6
13-1300	B	1/2" IPS or 3/4" Copper	6
13-1302	B	3/4" IPS or 1" Copper	6
13-1304	B	1" IPS or 1-1/4" Copper	6
13-1306	B	1-1/4" IPS or 1-1/2" Copper	6
13-1308	B	1-1/2" IPS	6
13-1310	B	2" IPS	6
13-1312	B	2-1/2" IPS	1
13-1314	B	3" IPS	1
13-1316	B	3-1/2" IPS	1
13-1318	B	4" IPS	1

**STAINLESS STEEL 1 PIECE CLAMP 6" • TWO BOLT**

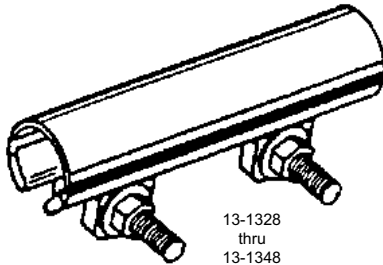

13-1328  
thru  
13-1348

13-1328	B	3/8" IPS or 1/2" Copper	6
13-1330	B	1/2" IPS or 3/4" Copper	6
13-1332	B	3/4" IPS or 1" Copper	6
13-1334	B	1" IPS or 1-1/4" Copper	6
13-1336	B	1-1/4" IPS or 1-1/2" Copper	6
13-1338	B	1-1/2" IPS	6
13-1340	B	2" IPS	6
13-1342	B	2-1/2" IPS	1
13-1344	B	3" IPS	1
13-1346	B	3-1/2" IPS	1
13-1348	B	4" IPS	1

**STEEL COMPRESSION UNIONS**

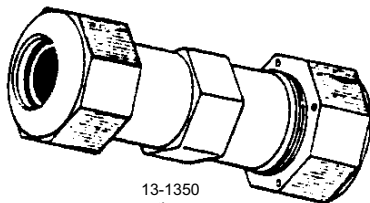

13-1350  
thru  
13-1360

13-1350	B	1/2" IPS Galvanized	12
13-1352	B	3/4" IPS Galvanized	12
13-1354	B	1" IPS Galvanized	12
13-1356	B	1-1/4" IPS Galvanized	12
13-1358	B	1-1/2" IPS Galvanized	12
13-1360	B	2" IPS Galvanized	12



**COMPRESSION UNIONS and TEES**

**B = Bulk**

ITEM NO.	PACK	DESCRIPTION	CTN. QTY.
----------	------	-------------	-----------

**BRASS COMPRESSION UNIONS • 3" LONG**

13-1500	B	3/8" IPS or 1/2" Copper	12
13-1502	B	1/2" IPS or 3/4" Copper	12
13-1506	B	3/4" IPS or 1" Copper	12
13-1510	B	1" IPS or 1-1/4" Copper	12
13-1512	B	1-1/4" IPS or 1-1/2" Copper	12
13-1516	B	1-1/2" IPS	12

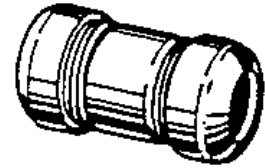

13-1500  
thru  
13-1516

**BRASS COMPRESSION UNIONS • 5" LONG**

13-1498	B	3/8" IPS or 1/2" Copper	12
13-1504	B	1/2" IPS or 3/4" Copper	12
13-1508	B	3/4" IPS or 1" Copper	12
13-1510A	B	1" IPS or 1-1/4" Copper	12
13-1514	B	1-1/4" IPS or 1-1/2" Copper	12
13-1518	B	1-1/2" IPS or 2" Copper	12
13-1520	B	2" IPS or 2-1/8" Copper	12

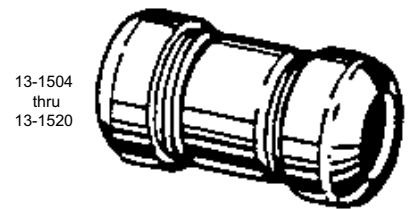

13-1504  
thru  
13-1520

**BRASS COMPRESSION TEES x IPS OUTLET**

13-1526	B	1/2" Copper x 1/2" IPS Outlet	12
13-1532	B	1/2" IPS x 1/2" IPS Outlet	12
13-1530	B	1/2" IPS x 3/4" IPS Outlet	12
13-1534	B	3/4" IPS x 1/2" IPS Outlet	12
13-1536	B	3/4" IPS x 3/4" IPS Outlet	12
13-1528	B	3/4" IPS x 1" IPS Outlet	12
13-1538	B	1" IPS x 1" IPS Outlet	12
13-1540	B	1-1/4" IPS x 1-1/4" IPS Outlet	12
13-1542	B	1-1/2" IPS x 1-1/2" IPS Outlet	12
13-1544	B	2" IPS x 2" IPS Outlet	12

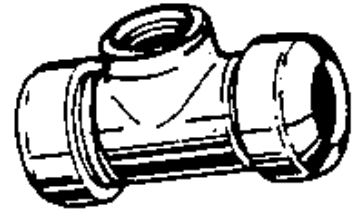

13-1526  
thru  
13-1544

**PLASTIC COMPRESSION UNIONS**

13-1394	B	1/2" Copper or CPVC	15
13-1396	B	3/4" Copper or CPVC	30
13-1398	B	1" Copper or CPVC	24
13-1400	B	1/2" PVC	30
13-1402	B	3/4" PVC	24
13-1404	B	1" PVC	18
13-1406	B	1-1/4" PVC	12
13-1408	B	1-1/2" PVC	15
13-1410	B	2" PVC	12
13-1412	B	2-1/2" PVC	1
13-1414	B	3" PVC	1
13-1416	B	4" PVC	1



13-1394  
thru  
13-1416



B = Bulk

**PLASTIC COMPRESSION  
TEES and ADAPTERS**

ITEM NO.	PACK	DESCRIPTION	CTN. QTY.
<b>PLASTIC COMPRESSION TEES</b>			
13-1452	B	1/2" Copper x 1/2" FIP	12
13-1454	B	3/4" Copper x 3/4" FIP	34
13-1420	B	1/2" PVC x 1/2" FIP	24
13-1422	B	1/2" PVC x 1/2" Slip	24
13-1424	B	3/4" PVC x 3/4" FIP	20
13-1426	B	3/4" PVC x 3/4" Slip	20
13-1456	B	3/4" PVC x 1/2" FIP	20
13-1428	B	1" PVC x 1" FIP	12
13-1430	B	1" PVC x 1" Slip	12
13-1432	B	1-1/4" PVC x 1-1/4" FIP	8
13-1434	B	1-1/4" PVC x 1-1/4" Slip	8
13-1436	B	1-1/2" PVC x 1-1/2" FIP	6
13-1438	B	1-1/2" PVC x 1-1/2" Slip	6
13-1440	B	2" PVC x 2" FIP	5
13-1442	B	2" PVC x 2" Slip	5

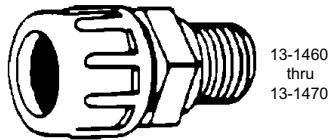
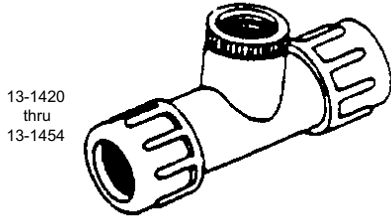

**PLASTIC COMPRESSION MALE ADAPTERS**

13-1460	B	1/2" PVC Male Adapter	12
13-1462	B	3/4" PVC Male Adapter	12
13-1464	B	1" PVC Male Adapter	24
13-1466	B	1-1/4" PVC Male Adapter	18
13-1468	B	1-1/2" PVC Male Adapter	16
13-1470	B	2" PVC Male Adapter	12

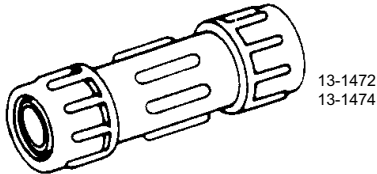

**PLASTIC PEX PIPE FITTINGS**

13-1472	B	1" PVC Pex Coupling	24
13-1474	B	1-1/4" PVC Pex Coupling	15
13-1476	B	1" PVC Pex Male Adapter	18
13-1478	B	1-1/4" PVC Pex Male Adapter	12

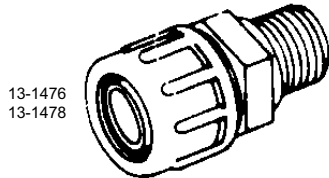

**PLASTIC NUTS FOR COMPRESSION UNIONS**

13-1380	B	1/2"	12
13-1382	B	3/4"	12
13-1384	B	1"	12
13-1386	B	1-1/4"	12
13-1388	B	1-1/2"	12
13-1390	B	2"	12

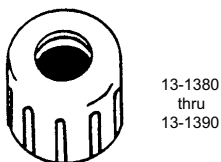

**REPLACEMENT GASKETS**

**B = Bulk  
C = Carded  
P = Poly Bag**

ITEM NO.	PACK	DESCRIPTION	CTN. QTY.
----------	------	-------------	--------------

**GASKETS FOR BRASS COMPRESSION FITTINGS**

13-1548	B	1/2" Copper	12
13-1549	C	Same as above carded (2 per card)	6
13-1550	B	1/2" IPS	12
13-1550P	P	Same as above Poly Bag	12
13-1551	C	Same as above carded (2 per card)	6
13-1552	B	3/4" IPS	12
13-1552P	P	Same as above Poly Bag	12
13-1553	C	Same as above carded (2 per card)	6
13-1554	B	1" IPS	12
13-1554P	P	Same as above Poly Bag	12
13-1555	C	Same as above carded (2 per card)	6
13-1556	B	1-1/4" IPS	12
13-1557	C	Same as above carded (2 per card)	6
13-1558	B	1-1/2" IPS	12
13-1559	C	Same as above carded (2 per card)	6
13-1560	B	2" IPS	12
13-1561	C	Same as above carded (2 per card)	6

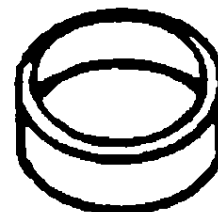

13-1548  
thru  
13-1561

**GASKETS FOR PLASTIC COMPRESSION FITTINGS**

13-1480	B	1/2" IPS	12
13-1480P	P	Same as above Poly Bag	12
13-1481	C	Same as above carded (2 per card)	6
13-1482	B	3/4" IPS	12
13-1482P	P	Same as above Poly Bag	12
13-1483	C	Same as above carded (2 per card)	6
13-1484	B	1" IPS	12
13-1484P	P	Same as above Poly Bag	12
13-1485	C	Same as above carded (2 per card)	6
13-1486	B	1-1/4" IPS	12
13-1486P	P	Same as above Poly Bag	12
13-1487	C	Same as above carded (2 per card)	6
13-1488	B	1-1/2" IPS	12
13-1488P	P	Same as above Poly Bag	12
13-1489	C	Same as above carded (2 per card)	6
13-1490	B	2" IPS	12
13-1490P	P	Same as above Poly Bag	12
13-1491	C	Same as above carded (2 per card)	6
13-1492	B	2-1/2" IPS	1



13-1480  
thru  
13-1492



**B = Bulk**  
**C = Carded**  
**P = Poly Bag**

**REPAIR ITEMS**

ITEM NO.	PACK	DESCRIPTION	CTN. QTY.
----------	------	-------------	-----------



**SNAP - ON • REPAIR COUPLINGS**

20-2012	P	1/2" Coupling	36
20-2013	P	3/4" Coupling	36
20-2036	P	1" Coupling	36
20-2037	P	1-1/4" Coupling	10
20-2038	P	1-1/2" Coupling	10
20-2039	P	2" Coupling	10

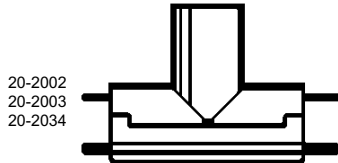

**SNAP - ON • REPAIR TEES**

20-2002	P	1/2" Tee	10
20-2003	P	3/4" Tee	10
20-2034	P	1" Tee	10
20-2032	P	1/2" Tapped Tee	10
20-2033	P	3/4" Tapped Tee	10

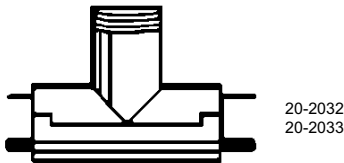

**REPAIR COUPLING**

20-2051	C	1/2"	6
20-2053	C	3/4"	6
20-2055	C	1"	6

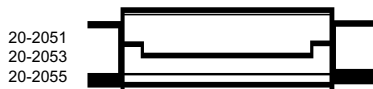

**REPAIR SADDLE TEES • SNAPS OVER PVC PIPE**

20-2070	B	1/2" PVC x 1/2" Slip Outlet	25
20-2071	C	Same as above carded	6
20-2072	B	3/4" PVC x 3/4" Slip Outlet	25
20-2073	C	Same as above carded	6
20-2074	B	3/4" PVC x 1/2" Slip Outlet	25
20-2075	C	Same as above carded	6
20-2076	B	1" PVC x 1" Slip Outlet	25
20-2077	C	Same as above carded	6
20-2078	B	1" PVC x 1/2" Slip Outlet	25
20-2079	C	Same as above carded	6

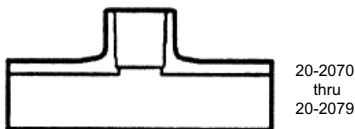

20-2080	B	1/2" PVC x 1/2" FIP	25
20-2081	C	Same as above carded	6
20-2082	B	3/4" PVC x 1/2" FIP	25
20-2083	C	Same as above carded	6
20-2084	B	1" PVC x 1/2" FIP	25
20-2085	C	Same as above carded	6

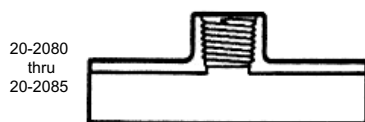



**REPAIR ITEMS**

**B = Bulk  
C = Carded**

ITEM NO.	PACK	DESCRIPTION	CTN. QTY.
----------	------	-------------	-----------

**TELESCOPING PVC REPAIR COUPLINGS**

20-2100	B	1/2" PVC Slip x Spigot	30
20-2101	C	Same as above carded	6
20-2102	B	3/4" PVC Slip x Spigot	24
20-2103	C	Same as above carded	6
20-2104	B	1" PVC Slip x Spigot	18
20-2105	C	Same as above carded	6
20-2106	B	1-1/4" PVC Slip x Spigot	12
20-2108	B	1-1/2" PVC Slip x Spigot	12
20-2110	B	2" PVC Slip x Spigot	8
20-2112	B	2-1/2" PVC Slip x Spigot	4
20-2114	B	3" PVC Slip x Spigot	3
20-2116	B	4" PVC Slip x Spigot	2

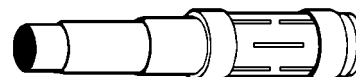

20-2100  
thru  
20-2116

**COPPER REPAIR COUPLINGS**

18-0702	B	1/2" x 12" Long	12
18-0706	B	3/4" x 12" Long	12



18-0702  
18-0706

**NO HUB COUPLINGS**

13-1670	B	1-1/2"	100
13-1672	B	2"	100
13-1674	B	2" x 1-1/2"	100
13-1676	B	3"	100
13-1678	B	4"	100

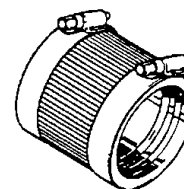

13-1670  
thru  
13-1678

**BAND SEAL COUPLINGS**

13-1680	B	1-1/2" Bath Waste x 1-1/2" C.I./DWV/Steel	24
13-1682	B	1-1/2" Bath Waste x 2" C.I./DWV/Steel	24
13-1684	B	3" Cast Iron x 2" C.I./DWV/Steel	24
13-1686	B	4" Cast Iron x 3" C.I./DWV/Steel	24

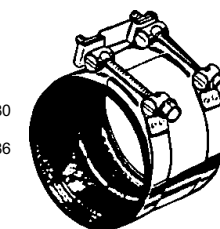

13-1680  
thru  
13-1686

**CALDER COUPLINGS**

13-1690	B	4" Clay to Clay	36
13-1692	B	4" Clay to 4" Cast Iron bushing	90
13-1694	B	4" Clay to 3" Cast Iron bushing	90
13-1698	B	4" Plug	45
25-3955	B	3" Trailer Park Connector	24



13-1690  
thru  
13-1698



25-3955



**B = Bulk**

**FLEXIBLE RUBBER FITTINGS**

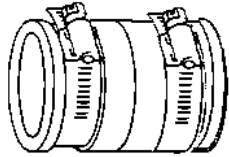

25-6758  
thru  
25-6802

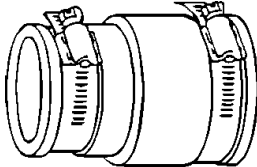

25-6813  
thru  
25-6850

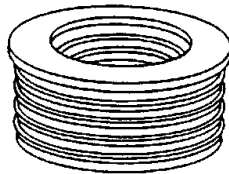

25-6806  
thru  
25-6812



25-6854  
25-6858

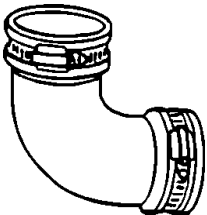

25-6830  
thru  
25-6836

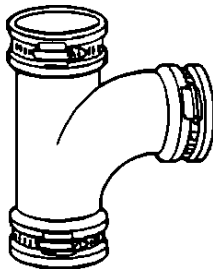

25-6840  
thru  
25-6846

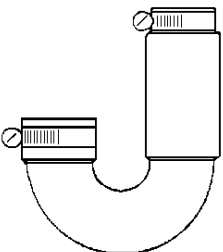

25-6860

ITEM NO.	PACK	DESCRIPTION	CTN. QTY.
----------	------	-------------	-----------

**DRAIN TRAP CONNECTORS**

25-6758	B	Connects 1-1/4" or 1-1/2" tubular together	12
25-6800	B	1-1/2" or 1-1/4" Tubular x 1-1/2" DWV or Steel	12
25-6802	B	1-1/2" or 1-1/4" Tubular x 2" DWV or Steel	12

**PIPE CONNECTORS •**

**CONNECTS CAST IRON, PLASTIC, COPPER OR STEEL**

25-6813	B	1-1/4" x 1-1/4" Flexible connector	12
25-6804	B	1-1/2" x 1-1/4" Flexible connector	12
25-6814	B	1-1/2" x 1-1/2" Flexible connector	12
25-6817	B	2" x 1-1/2" Flexible connector	12
25-6816	B	2" x 2" Flexible connector	12
25-6815	B	3" x 1-1/2" Flexible connector	12
25-6819	B	3" x 2" Flexible connector	12
25-6818	B	3" x 3" Flexible connector	12
25-6827	B	4" x 1-1/2" Flexible connector	12
25-6823	B	4" x 2" Flexible connector	12
25-6820	B	4" x 3" Flexible connector	12
25-6822	B	4" x 4" Flexible connector	12
25-6824	B	6" x 4" Flexible connector	12
25-6826	B	6" x 6" Flexible connector	12

25-6828	B	4" Clay x 4" DWV or Steel	12
25-6850	B	4" Concrete x 4" DWV or Steel	12

**RUBBER DONUTS • C.I. HUB x DWV or STEEL**

25-6806	B	2" x 2"	12
25-6808	B	3" x 3"	12
25-6810	B	4" x 3"	12
25-6812	B	4" x 4"	12

**RUBBER BUSHINGS •**

**Used to Reduce Hub of Rubber Tees and Elbows**

25-6854	B	2" x 1-1/2"	12
25-6858	B	3" x 2"	12

**QWIK ELBOWS**

25-6830	B	1-1/2"	12
25-6832	B	2"	12
25-6834	B	3"	12
25-6836	B	4"	12

**QWIK TEES**

25-6840	B	1-1/2"	12
25-6842	B	2"	12
25-6844	B	3"	12
25-6846	B	4"	12

**QWIK TRAP**

25-6860	B	1-1/2"	12
---------	---	--------	----



**MISCELLANEOUS**

**B = Bulk  
C = Carded  
P = Poly Bag**

ITEM NO.	PACK	DESCRIPTION	CTN. QTY.
----------	------	-------------	-----------

**WASHING MACHINE DRAIN CONNECTOR**

25-6880	B	Rubber Washing machine drain connector	12
---------	---	--	----

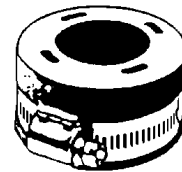

25-6880

**CLEAN - OUT CAPS**

25-6900	B	1-1/2" Fast cap	12
25-6910	B	2" Fast cap	12
25-6920	B	3" Fast cap	12
25-6930	B	4" Fast cap	12

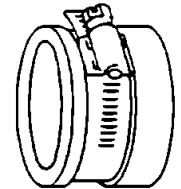

25-6900  
thru  
25-6930

**PLUMBERS TAPE**

13-1600	B	Light Pattern • 28 Gauge 3/4 x 10 Ft	100
13-1601	C	Same as above carded	6
13-1606	B	Light Pattern • 28 Gauge 3/4 x 100 Ft	1
13-1602	B	Heavy Pattern • 22 Gauge 3/4 x 10 Ft	100
13-1603	C	Same as above carded	6
13-1610	B	Solid Copper • 3/4 x 25 FT	10
13-1612	B	Copper Plated • 3/4 x 10 Ft	10
13-1613	C	Same as above carded	6
13-1614	B	Plastic • 3/4 x 100 Ft	50
13-1615	C	Same as above carded • 10 Ft	6



13-1600  
thru  
13-1603

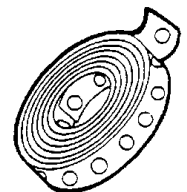

13-1610  
thru  
13-1613



13-1614  
13-1615

**STRAPS**

13-1604	B	5/8 x 18" • Ridgid steel strap	10
13-1608	B	1/2-3/4-1" • Copper pipe support	10



13-1608

**PLASTIC COPPER PIPE SLEEVE • 1/2 • 3/4 • 1 Inch**

13-1620	B	Hot / Red • 200 Ft • 6 Mill	20
13-1622	B	Cold / Blue • 200 Ft • 6 Mill	20
27-9904	B	4" • Sleeve for Perforated Pipe	1
27-9906	B	Drain EEZ 3" x 10 ft.	1
27-9908	B	Drain EEZ 4" x 10 ft.	1

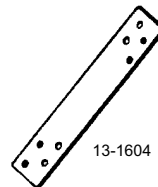

13-1604



27-9904  
thru  
27-9908

**PLASTIC TUBE CLAMPS**

13-1624	B	1/2" Copper tube size	100
13-1625	C	Same as above carded (4 per card)	6
13-1626	B	3/4" Copper or 1/2" IPS	100
13-1627	C	Same as above carded (4 per card)	6
13-1628	B	1/2" Copper tube hanger	100
13-1628P	P	Same as above Poly Bag (10 per poly bag)	12
13-1629	C	Same as above carded (4 per card)	6
13-1630	B	3/4" Copper or 1/2" IPS hanger	100
13-1632	B	1" Copper or 3/4" IPS hanger	100

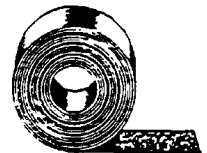

13-1620  
13-1622



13-1628  
thru  
13-1632

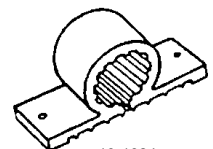

13-1624  
thru  
13-1627



**MISCELLANEOUS  
CONTINUED**

**B = Bulk  
C = Carded  
P = Poly Bag**

ITEM NO.	PACK	DESCRIPTION	CTN. QTY.
----------	------	-------------	--------------



13-1634  
thru  
13-1644

**GALVANIZED PIPE STRAPS**

13-1634	B	1/2" IPS	100
13-1635	C	Same as above carded (6 per card)	6
13-1636	B	3/4" IPS	100
13-1637	C	Same as above carded (6 per card)	6
13-1638	B	1" IPS	100
13-1640	B	1-1/4" IPS	100
13-1642	B	1-1/2" IPS	100
13-1644	B	2" IPS	100



13-1668

13-1660  
thru  
13-1666

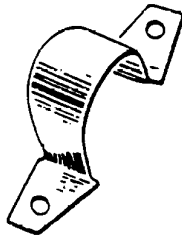

**COPPER TUBING STRAPS**

13-1660	B	3/8" O.D. Tubing	100
13-1662	B	1/2" O.D. Tubing	100
13-1663	C	Same as above carded (4 per card)	6
13-1664	B	3/4" O.D. Tubing	50
13-1665	C	Same as above carded (4 per card)	6
13-1666	B	1" O.D. Tubing	50

13-1668	B	Nails for Copper Straps	100
---------	---	-------------------------	-----

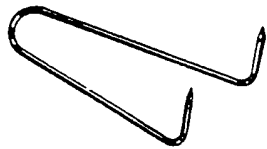

13-1646  
thru  
13-1650

**PIPE HOOKS • PLASTIC COATED STEEL**

13-1650P	B	1/2" x 4" Long 50 PAK	100
13-1646P	B	1/2" x 6" Long 50 PAK	1
13-1646P-5	B	1/2" x 6" Long 5 PAK	1
13-1647	C	Same as above carded (4 per card)	6
13-1652P	B	3/4" x 4" Long 50 PAK	100
13-1648P	B	3/4" x 6" Long 50 PAK	100
13-1648P-5	B	3/4" x 6" Long 5 PAK	100
13-1649	C	Same as above carded (4 per card)	6

13-1656P  
thru  
13-1659



**PLASTIC COATED COPPER • NAIL-ON STRAPS**

13-1656P	B	1/2" 10 PAK	100
13-1657	C	Same as above carded (4 per card)	6
13-1658P	B	3/4" 10 PAK	100
13-1659	C	Same as above carded (4 per card)	6

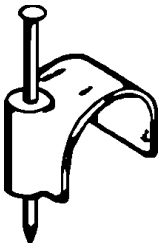

15-5564  
thru  
15-5567

15-8380  
thru  
15-8381

**PLASTIC TUBING CLIPS**

15-5564	B	1/4" O.D. With nail	100
15-5564P	P	Same as above Poly Bag (10 per bag)	10
15-5565	C	Same as above carded (15 per card)	6
15-5566	B	3/8" • 0455 O.D With nail	100
15-5567	C	Same as above carded (6 per card)	6
15-8380	B	1/2" • 0700 O.D. With nail	100
15-8380P	P	Same as above Poly Bag (10 per bag)	10
15-8381	C	Same as above carded (6 per card)	6

18-6020  
thru  
18-6024

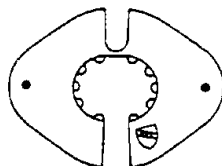

**COPPER PIPE INSULATOR • DRILL 1-3/8" HOLE**

18-6020	B	1/2" Nominal tube size	50
18-6022	B	3/4" Nominal tube size	50
18-6024	B	1" Nominal tube size	25



**MISCELLANEOUS  
CONTINUED**

**B = Bulk  
C = Carded**

ITEM NO.	PACK	DESCRIPTION	CTN. QTY.
<b>COPPER HANGERS</b>			
13-1878	B	1/2" x 12" Milford Copper Hanger	1
13-1880	B	3/4" x 12" Milford Copper Hanger	1
13-1882	B	1-1/2" x 12" Milford Copper Hanger	1
13-1884	B	2" x 12" Milford Copper Hanger	1
13-1886	B	3" x 12" Milford Copper Hanger	1
13-1888	B	4" x 12" Milford Copper Hanger	1
<b>COPPER STUB OUT</b>			
18-2690	B	1/2" x 6" M Type bullet	100
<b>PLASTIC J HOOKS • FOR DWV PIPE</b>			
13-1870	B	1-1/2"	25
13-1872	B	2"	25
13-1874	B	3"	25
13-1876	B	4"	25
<b>COPPER TEST PLUGS</b>			
13-1810	B	1/2"	10
13-1811	C	Same as above carded	6
13-1812	B	3/4"	10
13-1813	C	Same as above carded	6
13-1814	B	1"	5
13-1815	C	Same as above carded	6
13-1816	B	1-1/4"	5
13-1817	C	Same as above carded	6
<b>ECONO - TEST PLUGS</b>			
13-1818	B	1-1/2"	25
13-1820	B	2"	25
13-1822	B	3"	25
13-1824	B	4"	25
<b>INFLATABLE TEST PLUGS</b>			
12-1020	B	1-1/4" • 1-1/2" • 2"	10
12-1022	B	3" • 4"	10
12-1030	B	4 Foot Extension Hose	10
<b>SINK HANGERS</b>			
13-1704	B	Stamped Steel • For most china lavs	12
13-1705	C	Same as above carded (2 per card)	6
13-1706	B	"Z" Hanger • Adjustable 5" to 16"	1
<b>BOILER PLUGS</b>			
13-3252	B	1/4" Boiler Plug	12
13-3253	C	1/4" Same as above carded	6
13-3254	B	5/16" Boiler Plug	12
13-3255	C	5/16" Same as above carded	6
13-3256	B	3/8" Boiler Plug	12
13-3257	C	3/8" Same as above carded	6

