

SINK STRAINERS AND REPLACEMENT BASKETS

BULK NO.	CTN. QTY.	DESCRIPTION	CARD NO.	CTN. QTY.
TWO INCH OUTLET STRAINERS				
03-1010	24	Flat top strainer Domestic	03-1011	6
03-1028	25	Laundry tray plug import	03-1029	6
03-1028P	12	Same as above (Power Pack)	-----	--
03-1026	25	Flat top strainer import	03-1027	6
03-1026P	12	Same as above (Power Pack)	-----	--
03-1022	25	Flat top strainer Long Shank	03-1023	6
03-1024	25	Laundry tray plug Long Shank	03-1025	6
03-1100	100	Junior duo strainer	03-1101	6
03-1100P	12	Same as above (Power Pack)	-----	--
03-1110	24	Bail basket bar strainer	03-1111	6
3-1/2 INCH OUTLET STRAINERS				
03-1038	25	Extra heavy duty CP Brass duo strainer (Kohler Style)	03-1039	6
03-1040	25	Stainless steel duo strainer Domestic	03-1041	6
03-1044	25	CP brass code duo strainer Domestic	03-1045	6
03-1046	25	EZ-ON strainer Domestic	-----	--
03-1048	25	EZ-ON code strainer Domestic	03-1049	6
03-1030	50	EZ-ON strainer Import	03-1031	6
03-1050	50	Stainless steel duo strainer Import	03-1051	6
03-1050P	24	Same as above (Power Pack)	-----	--
03-1064	50	Oil Rub Bronze Strainer	03-1056	6
03-1066	50	Satin Nickel Strainer	03-1067	6
03-1078	50	White Strainer	03-1069	6
03-1060	50	Plastic body SS top strainer	03-1061	6
03-1060P	24	Same as above (Power Pack)	-----	--
03-1064	50	Oil Rub Bronze (Post Type)	03-1065	6
03-1066	50	Satin Nickel (Post Type)	03-1067	6
03-1068	50	White strainer (Post Type)	03-1069	6
03-1070	48	Flat top strainer Domestic	03-1071	6
03-1072	50	Flat top strainer Import	03-1073	6
03-1072P	12	Same as above (Power Pack)	-----	--
03-1128	50	Spin type basket strainer w/Brass nuts	-----	--
03-1128P	12	Same as above w/Zinc nuts	03-1129	6
03-1130	25	Spin-n-Grin basket strainer Domestic	03-1131	6
03-1150	50	Sink strainer Long Shank	03-1151	6

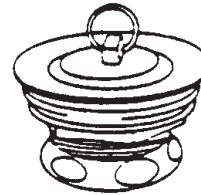

03-1024
03-1025
03-1028
03-1029

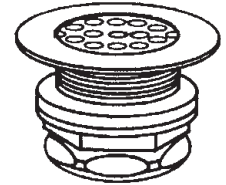

03-1010 03-1022 03-1026
03-1011 03-1023 03-1027

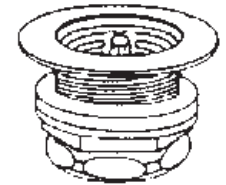

03-1100
03-1101
03-1100P



03-1110
03-1111



03-1040
03-1041
03-1044
03-1045



03-1030
03-1046
03-1048
03-1049

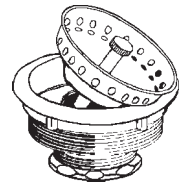

03-1038
03-1039
03-1050
03-1051
03-1064
thru
03-1069



03-1060
03-1061

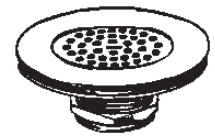

03-1070
thru
03-1073

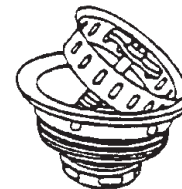

03-1128
thru
03-1131

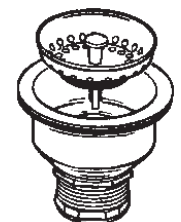

03-1150
03-1151



REPLACEMENT BASKETS FOR SINK STRAINERS

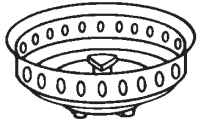

03-1042
03-1043

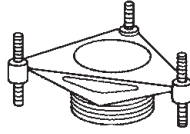

SRS-3802
03-1047

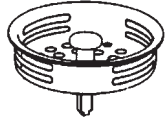

03-1052
03-1053
03-1063



03-1054
03-1055

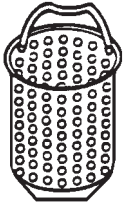

03-1112
03-1113

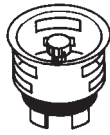

03-1102
03-1103

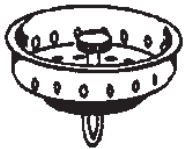

03-1122
03-1123

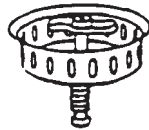

03-1132
03-1133
03-1135

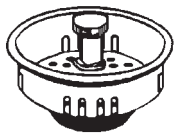

03-1300
03-1301
03-1300P

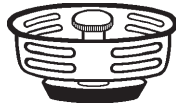

03-1302
03-1303
03-1302P

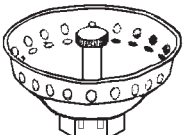

03-1304
03-1305



03-1306
03-1307

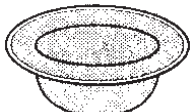

03-1380
03-1382
03-1384
03-1386



BULK NO.	CTN. QTY.	DESCRIPTION	CARDED NO.	CTN. QTY.
03-1042	12	Sterling basket only 60-523	03-1043	6
SRS-3802	-	Yoke assembly S-3802	03-1047	6
03-1052	100	Post type duo basket only	03-1053	6
03-1062	100	Post type for Plastic Strainer	03-1063	6
03-1054	100	Long post basket only	03-1055	6
03-1102	100	Junior duo basket only	03-1103	6
03-1112	12	Bridgeport type basket only	03-1113	6
03-1122	12	Stainless pronged basket only	03-1123	6
03-1132	12	Spin-n-Grin basket only	03-1133	6
		Spin Basket for 03-1129	03-1135	6
03-1300	6	Derlin fit most duo basket only	03-1301	6
03-1300P	24	Same as above (Power Pack)	-----	-
03-1302	6	Fit most duo basket only	03-1303	6
03-1302P	24	Same as above (Power Pack)	-----	-
03-1304	100	Four prong basket only	03-1305	6
03-1306	12	Kohler basket only 30122	03-1307	6
03-1380	12	Stainless Steel Mesh Kitchen Strainer		
03-1382	12	Stainless Steel Mesh Shower Strainer		
03-1384	12	Stainless Steel Mesh Bathtub Strainer		
03-1386	12	Stainless Steel Mesh Lavatory Strainer		





DECORATIVE
KITCHEN AND BAR

BULK NO.	DESCRIPTION	CARDED NO.	FINISHES
BASKET STRAINERS			
30012	STRAINER , post type, fits 3-1/2" opening	30013	AL P SS W OB SN
30052	STRAINER , spin type, fits 3-1/2" opening	30053	AL P SN W SS
30072	STRAINER , post type fits 3-1/2" opening heavy duty Plastic (European Style)	30073	AL W C OB SN
30082	STRAINER , jr. bail type, fits 2" opening	30083	AL P SS W
30150	STOPPER , garbage disposal, fits in-sink-erator	30151	C P W AL
30152	FLANGE , garbage disposal, fits in-sink-erator	-----	C P W AL
-----	STOPPER & FLANGE , garbage disposal, fits in-sink-erator	30155	C P W AL SN
30156	STOPPER , garbage disposal, fits waste king	-----	C P W AL
30158	FLANGE , garbage disposal, fits waste king	-----	C P W AL
-----	STOPPER & FLANGE , garbage disposal, fits waste king	30161	C P W AL
30170	STOPPER & FLANGE , fits in-sink-erator & waste king heavy duty plastic pushes into existing flange (European Style)	30171	W AL C OB SN
30200	AIR GAP KIT , complete	30201	P W AL EU B
30202	AIR GAP CAP , cap only	30203	P W AL EU B SN
30250	WATER DISPENSER , faucet only, not for instant hot water application	30251	C P W AL EU B
30260	WATER DISPENSER , long reach spout, faucet only, not for hot instant water application	30261	C P W AL EU B SN
30300	SOAP DISPENSER , for soap and lotion	30301	C P W AL EU B
30320	SOAP DISPENSER , deluxe model	30321	C P W AL EU B SN
30330	SOAP DISPENSER , Non - Metallic	30331	C P W AL
30350	SPRAY KIT , includes spray head, 4' hose and guide	30351	W AL
30352	SPRAY HEAD ONLY , white plastic	30353	W AL
30354	4' HOSE ONLY , white plastic	-----	W
30356	HOSE GUIDE ONLY , white plastic	30357	W AL
30400	FAUCET HOLE COVER , 2" diameter brass	30401	C P W AL EU B

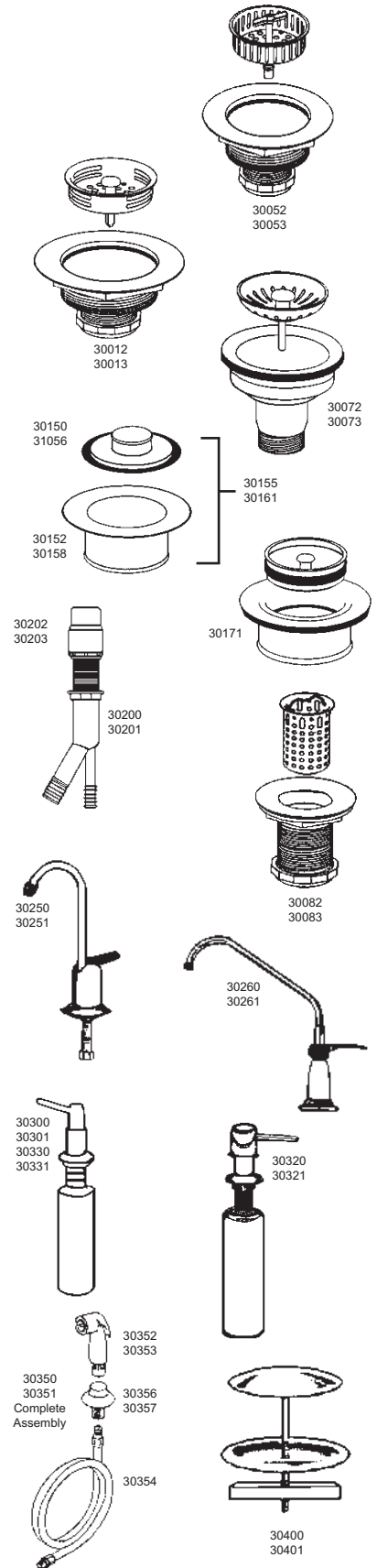

USE BULK OR CARDED NUMBER PLUS ONE OF THE FOLLOWING FINISH CODES TO INDICATE THE PART NUMBER OF THE PREFERRED FINISH:

C = Chrome **P** = Polished Brass **W** = White **AL** = Almond **EU** = Euro White **B** = Bone
SN = Satin Nickel **SS** = Stainless Steel **A** = Antique Bronze **OB** = Oil Rubbed Bronze



ACCESSORIES

BULK NO.	CTN. QTY.	DESCRIPTION	CARDED NO.	CTN. QTY.
----------	-----------	-------------	------------	-----------

SINK HOLE COVERS

03-1444	50	Two inch faucet hole cover	03-1445	6
03-1446	100	Standard faucet hole cover	03-1447	6
03-1452	12	1-5/8" OD x 1-1/2" ID for S.S. sinks	03-1453	6
03-1460	12	Amer.Std. 1-1/4 snap in hole cover	-----	--
		White ABS 1-3/4 HD hole cover	03-1455	6
		Almond ABS 1-3/4 HD hole cover	03-1457	6

AIR GAPS

05-2098	10	1-1/2 ABS Plumbing vent	05-2099	6
		Copper deck air gap	05-2103	6
05-2104	10	Plastic air gap (UPC)	05-2105	6
05-2104P	12	Same as above (Power Pack)		
05-2106	10	Plastic air gap with CP brass top	05-2107	6
05-2102	96	US Brass/Eastman Airgap		
		Air gap top assembly	05-2165	6
05-2150	10	Air gap cap short US Brass	05-2151	6
05-2170	10	Air gap cap tall Import	05-2171	6
05-2160	10	Air gap plastic inner cap		
05-2160E	10	Air gap extension		
		Air gap intercap and extension	05-2161	6
05-2162	10	Air gap lock nut and washer	05-2163	6
		Disposal rubber connector	02-3751	6
		Air gap installation kit • Plastic air gap • 8' x 5/8" Rubber Hose • 3' x 7/8" Rubber Hose • 2x 5/8" S.S. clamps • 2x 7/8" S.S. clamps	05-2109	6

SOAP DISPENSER

09-1000	10	Soap dispenser complete	09-1001	6
		Satin Nickel	09-1003	6
		Oil Rub Bronze	09-1005	6
		White	09-1007	6
09-1008	1	Pump only	09-1009	6
09-1002	10	Bottle only		

HOSE and SPRAY

08-1524	10	White spray head only	08-1525	6
08-1528	10	Black spray head only	08-1529	6
		Chrome spray head only	08-1519	6
08-1520	10	30" hose only	08-1521	6
08-1522	10	48" hose only	08-1523	6
08-1526	10	White spray head with hose set	08-1527	6
08-1530	10	Black spray head with hose set	08-1531	6
		Chrome spray head with Hose Set	08-1535	6
		Delta/Hometek Hose & Spray	08-1533	6
08-1508	10	White hose guide	08-1509	6
08-1510	10	Chrome hose guide	08-1511	6
08-1530W	10	Washer for spray head	-----	--
08-1540	10	MR514-A White brush only	-----	--

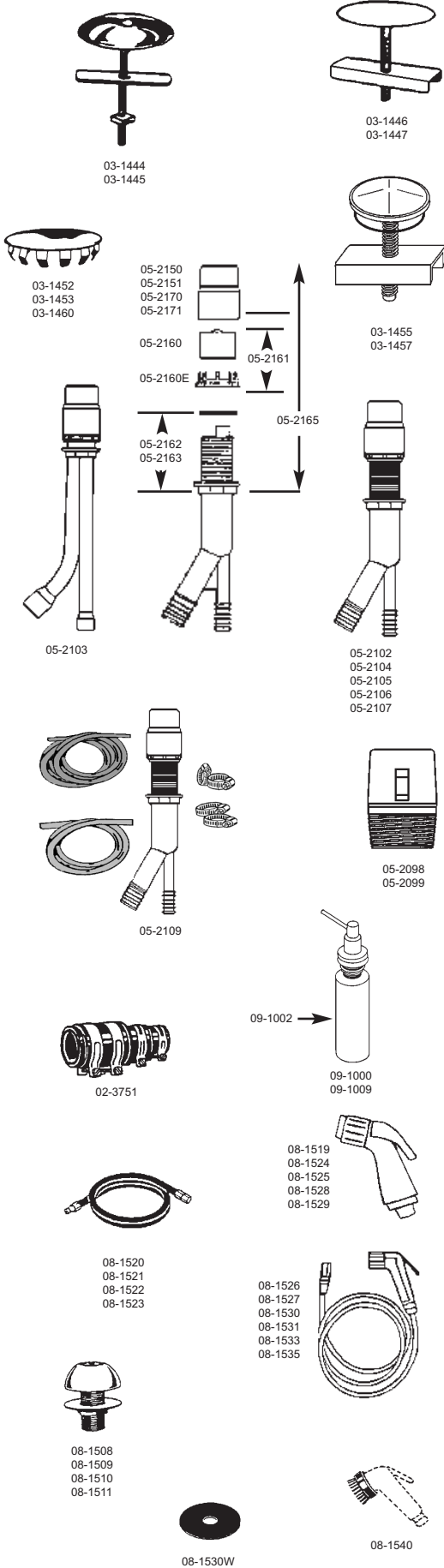

DISPOSAL PARTS

BULK NO.	CTN. QTY.	DESCRIPTION	CARD NO.	CTN. QTY.
SPLASH GUARDS				
39-9000	1	1010 333SS and up ISE models	39-9001	6
39-9002	1	1439 Badger and 333 ISE models	39-9003	6
39-9052	1	WKSG-2 Waste King fits 2600 and 2800 models	39-9053	6
39-9054	1	WKSG-3Waste King fits 5000 and 8000 models	39-9055	6
39-9056	1	Whirl-A-Way and Sinkmaster	39-9057	6
39-9066	1	New Small Top Insert Splash Guard & Stopper		
02-4010	1	Fit-All	02-4011	6

Note:
For other disposal parts
see section 39 of catalog

STOPPERS

39-9006	1	1876 2 piece metal ISE	39-9007	6
39-9008	1	5029 Stopper gasket ISE	39-9009	6
39-9010	1	5032 Chrome metal ISE	39-9011	6
39-9012	1	4310 Plastic ISE	39-9013	6
39-9062	1	WKSC-2 Waste King plastic	39-9063	6
39-9064	1	WKSC-3 Waste King metal	39-9065	6
39-9068	1	Whirl-A-Way and Sinkmaster	39-9069	6
02-4012	1	Fit-All Stopper	02-4013	6
		Fit-All Strainer	02-4021	6

CONNECTION PARTS AND ACCESSORIES

39-9004	1	1470 Hush cushion ISE	39-9005	6
39-9036	1	New style badger hush cushion	39-9037	6
39-9032	1	5490 Flange for elbow ISE	39-9033	6
39-9034	1	2593 Flange for new style badger	39-9035	6
39-9018	1	8219 Plastic elbow ISE	39-9019	6
03-4248	1	ISE 7" Long plastic elbow	03-4249	6
		ISE New style elbow	03-4219A	6
39-9040	1	ISE Wrench	39-9041	6
39-9058	1	WK-TP Waste King plastic elbow	39-9059	6
39-9060	1	75015 Waste King hush cushion	39-9061	6



39-9000 - 39-9001
39-9002 - 39-9003
39-9056 - 39-9057



39-9052 - 39-9053
39-9054 - 39-9055



02-4010 - 02-4011

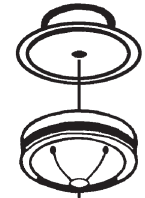

39-9066



39-9008 - 39-9009



39-9006 - 39-9007



39-9012 - 39-9013



39-9010 - 39-9011



39-9064 - 39-9065



39-9062 - 39-9063



02-4012 - 02-4013

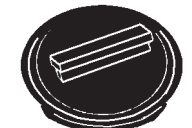

39-9068 - 39-9069



39-9004 - 39-9005
39-9036 - 39-9037



39-9032 - 39-9033



02-4021



39-9034 - 39-9035



39-9018 - 39-9019
03-4248 - 03-4249



39-9040 - 39-9041



39-9058 - 39-9059



03-4219A



39-9060 - 39-9061



B = BULK
C = CARDED

FLANGES



03-1500



03-1510
03-1512

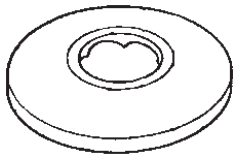

03-1518
03-1519

03-6011
03-6013
03-6014
03-6015
03-6021
03-6023
03-6025



03-1530
thru
03-1543

03-1600
thru
03-1603
and
03-1544
thru
03-1547



03-1546D
03-1547D
03-1548
03-1549
03-1576
03-1578

ITEM NO.	PACK	DESCRIPTION	CTN. QTY.
----------	------	-------------	-----------

HEX SURE GRIP

03-1500	B	1/2" IPS	25
---------	---	----------	----

FLAT SURE GRIP

03-1510	B	1/2" IPS	25
03-1512	B	3/4" IPS	25

SHOWER ARM

03-1518	B	1/2" Sure Grip • 13/16"	25
03-1519	C	Same as above carded	6

TUB SPOUT BEAUTY RING

03-6011	C	3-1/2" Chrome trim ring	6
03-6013	C	3-1/2" Polished brass trim ring	6
03-6014	B	3-1/2" Satin Nickel trim ring	6
03-6015	C	3-1/2" Satin Nickel trim ring	6
03-6021	C	2-1/8" Chrome trim ring • 7/8 ID also shower arm	6
03-6023	C	2-1/8" Polished brass trim ring	6
03-6025	C	2-1/8" Satin Nickel trim ring	6

REGULAR SURE GRIP

03-1530	B	3/8" IPS	25
03-1531	C	Same as above carded	6
03-1532	B	1/2" IPS • 7/8"	25
03-1533	C	Same as above carded	6
03-1534	B	3/4" IPS	25
03-1535	C	Same as above carded	6
03-1536	B	1" IPS	25
03-1537	C	Same as above carded	6
03-1538	B	1-1/4" IPS	25
03-1539	C	Same as above carded	6
03-1540	B	1-1/2" IPS	25
03-1541	C	Same as above carded	6
03-1542	B	2" IPS	25
03-1543	C	Same as above carded	6

TUBULAR SURE GRIP

03-1600	B	1/2" Copper tubing	25
03-1601	C	Same as above carded	6
03-1602	B	3/4" Copper tubing • 29/32"	25
03-1603	C	Same as above carded	6
03-1546	B	1-1/4" Tubular	25
03-1547	C	Same as above carded	6
03-1544	B	1-1/2" Tubular	25
03-1545	C	Same as above carded	6

BOX FLANGE SURE GRIP

03-1546D	B	1-1/4" Tubular x 3" OD	25
03-1547D	C	Same as above carded	6
03-1548	B	1-1/2" Tubular x 3" OD	25
03-1549	C	Same as above carded	6
03-1576	B	1-1/4" IPS x 3" OD	25
03-1578	B	1-1/2" IPS x 3" OD	25



FLANGES AND COVER TUBING

B = BULK
C = CARDED

ITEM NO.	PACK	DESCRIPTION	CTN. QTY.
----------	------	-------------	-----------

CHROME PLATED BRASS SURE GRIP FLANGE

03-1570	B	1/2" IPS	25
03-1572	B	3/4" IPS	25

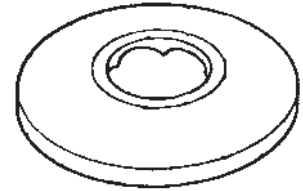

03-1570
03-1572

SPLIT CHROME PLATED FLANGES

03-1550	B	3/8" IPS or 1/2" Copper	25
03-1551	C	Same as above carded	6
03-1552	B	1/2" IPS or 3/4" Copper	25
03-1553	C	Same as above carded	6
03-1554	B	3/4" IPS	25
03-1555	C	Same as above carded	6
03-1556	B	1" IPS	25
03-1557	C	Same as above carded	6
03-1558	B	1-1/4" IPS	25
03-1559	C	Same as above carded	6
03-1560	B	1-1/2" IPS	25
03-1561	C	Same as above carded	6
03-1562	B	2" IPS	25
03-1563	C	Same as above carded	6

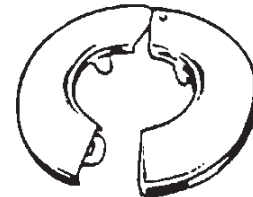

03-1550
thru
03-1563

PLASTIC SPLIT CHROME PLATED FLANGES

03-1580	B	3/8" IPS	25
03-1582	B	1/2" IPS	25
03-1583	C	Same as above carded	6
03-1584	B	3/4" IPS	25
03-1585	C	Same as above carded	6
03-1586	B	1" IPS	25
03-1587	C	Same as above carded	6
03-1588	B	1-1/4" IPS	25
03-1589	C	Same as above carded	6
03-1590	B	1-1/2" IPS	25
03-1591	C	Same as above carded	6
03-1592	B	2" IPS	25
03-1593	C	Same as above carded	6



03-1582
thru
03-1593

CHROME PLATED BRASS COVER TUBING 6FT LONG

03-5402	B	1-1/8 Fits 3/4" gal pipe	1
03-5406	B	1-3/8 Fits 1" gal pipe	1
03-5408	B	1-1/2" Fits 1-1/4 gal pipe	1
03-5412	B	2" Fits 1-1/2 gal pipe	1

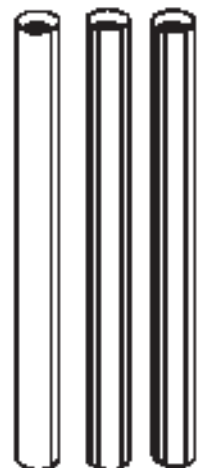

03-5402
thru
03-5412



**B = BULK
C = CARDED
P = POLY BAG**

**WASHERS FOR BASKET
STRAINERS AND P-TRAPS**

ITEM NO.	PACK	DESCRIPTION	CTN. QTY.
----------	------	-------------	--------------

SINK CONNECTION WASHERS

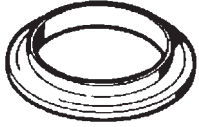

02-2050 - 02-2051



02-2052 - 02-2057



02-2066 - 02-2068

02-2050	B	W-251 1-1/2 Poly flanged tailpiece washer	100
02-2050P	P	W-251 1-1/2 Poly flanged tailpiece washer	12
02-2051	C	Same as above (2 ea in snap pack)	6
02-2052	B	W-251A 1-1/2 Cloth inserted tailpiece washer	100
02-2052P	P	W-251A 1-1/2 Cloth inserted tailpiece washer	12
02-2053	C	Same as above (2 ea in snap pack)	6
02-2054	B	W-251B 1-1/4 Cloth inserted tailpiece washer	100
02-2055	C	Same as above (2 ea in snap pack)	6
02-2056	B	W-252 1-1/2 Fiber tailpiece washer	100
02-2056P	P	W-252 1-1/2 Fiber tailpiece washer	12
02-2057	C	Same as above (2 ea in snap pack)	6
02-2058	B	W-253 2" Rubber strainer washer	100
02-2058P	P	W-253 2" Rubber strainer washer	12
02-2059	C	Same as above (1ea in snap pack)	6
02-2066	B	W-257 4" Rubber duo strainer washer	100
02-2066P	P	W-257 4" Rubber duo strainer washer	12
02-2067	C	Same as above (1ea rubber & nylon washer)	6
02-2068	B	W-258 4" Nylon duo strainer washer	100
02-2068P	P	W-258 4" Nylon duo strainer washer	

RUBBER - SLIP JOINT WASHERS

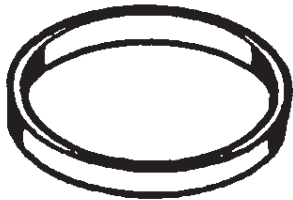

02-2250 - 02-2265

02-2250	B	W-304 1-1/4 Standard	100
02-2250P	P	W-304 1-1/4 Standard	12
02-2251	C	Same as above (2ea in snap pack)	6
02-2252	B	W-304A 1-1/4 Medium	100
02-2252P	P	W-304A 1-1/4 Medium	12
02-2253	C	Same as above (2ea in snap pack)	6
02-2254	B	W-305 1-1/2 Standard	100
02-2254P	P	W-305 1-1/2 Standard	12
02-2254D	P	W-305 1-1/2 Standard (12pc poly bag)	6
02-2255	C	Same as above (2ea in snap pack)	6
02-2256	B	W-305A 1-1/2 Medium	100
02-2257	C	Same as above (2ea in snap pack)	12
02-2258	B	W-306 2" Standard	100
02-2258P	P	W-306 2" Standard	12
02-2259	C	Same as above (2ea in snap pack)	6
02-2260	B	W-306A 2" Heavy	100
02-2264	B	W-308 1-1/4 Shallow	100
02-2265	C	Same as above (2ea in snap pack)	6



WASHERS FOR BASKET STRAINERS AND P-TRAP

B = BULK
C = CARDED
P = POLY BAG

ITEM NO.	PACK	DESCRIPTION	CTN. QTY.
----------	------	-------------	-----------

RUBBER - SLIP JOINT WASHERS

02-2266	B	W-309 1-1/2 x 1-1/4 Reducing	100
02-2266P	P	W-309 1-1/2 x 1-1/4 Reducing	12
02-2267	C	Same as above (2ea in snap pack)	6
02-2268	B	W-310 1-1/2 x 1-3/8 Reducing	100
02-2269	C	Same as above (2ea in snap pack)	6
02-2270	B	W-311 1-1/2 Shallow	100
02-2289	C	Assorted (8 in snap pack)	6

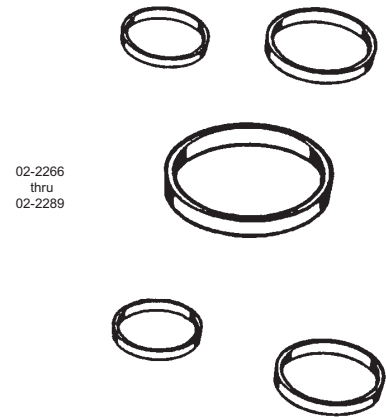

POLY - SLIP JOINT WASHERS

02-2280	B	W304P 1-1/4 Standard	100
02-2280P	P	W304P 1-1/4 Standard	12
02-2281	C	Same as above (2ea in snap pack)	6
02-2282	B	W-305P 1-1/2 Standard	100
02-2282P	P	W-305P 1-1/2 Standard	12
02-2283	C	Same as above (2ea in snap pack)	6
02-2284	B	W-306P 2" Standard	100
02-2285	C	Same as above (2ea in snap pack)	6
02-2286	B	W-309P 1-1/2 x 1-1/4 Reducing	100
02-2286P	P	W-309P 1-1/2 x 1-1/4 Reducing	12
02-2287	C	Same as above (2ea in snap pack)	6

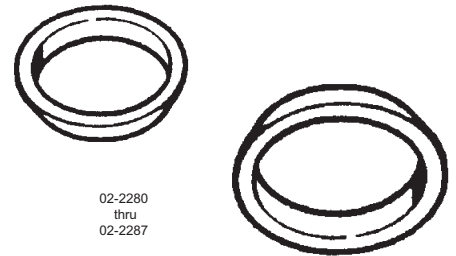

SOLUTION WASHERS with "PASSION GRIP" (For positive seals)

02-2290	B	1-1/4 Slip joint washer	100
02-2291	C	Same as above (2ea in snap pack)	6
02-2292	B	1-1/2 Slip joint washer	100
02-2293	C	Same as above (2ea in snap pack)	6
02-2296	B	1-1/2 x 1-1/4 Reducing slip joint washer	100
02-2297	C	Same as above (2ea in snap pack)	6
02-2294	B	1-1/2 Flanged tailpiece washer	100
02-2295	C	Same as above (2ea in snap pack)	6

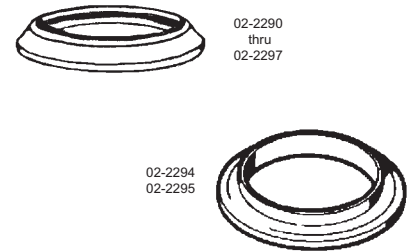

BRASS FRICTION RINGS

02-2310	B	R-6 1-1/4 Standard	100
02-2310P	P	R-6 1-1/4 Standard	12
02-2311	C	Same as above (2ea in snap pack)	6
02-2312	B	R-7 1-1/2 x 1-1/4 Reducing	100
02-2312P	P	R-7 1-1/2 x 1-1/4 Reducing	12
02-2313	C	Same as above (2ea in snap pack)	6
02-2314	B	R-8 1-1/2 Standard	100
02-2315	C	Same as above (2ea in snap pack)	6
02-2316	B	R-9 1-1/2 x 1-3/8 Reducing	100
02-2318	B	R-10 2" Standard	12
02-2318P	P	R-10 2" Standar	6

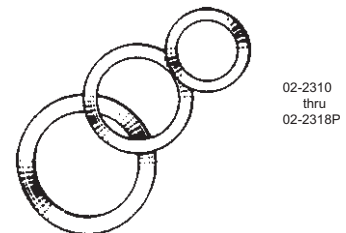

METAL JAM NUT WASHER

03-1470	B	1-1/4	100
03-1472	B	1-1/2	100



B = BULK
C = CARDED
P = POLY BAG

SLIP JOINT NUTS

ITEM NO.	PACK	DESCRIPTION	CTN. QTY.
----------	------	-------------	-----------

CHROME PLATED DIE CAST

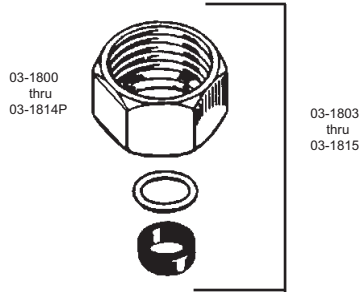

03-1800	B	1/2 x 7/16	25
03-1803	C	Same as above carded with washers	6
03-1804	B	1/2 x 1/2	25
03-1804P	P	1/2 x 1/2	12
03-1807	C	Same as above carded with washers	6
03-1807P	P	Same as above bagged with washers	12
03-1808	B	3/4 x 1/2	25
03-1811	C	Same as above carded with washers	6
03-1812	B	3/4 x 9/16	25
03-1814	B	1/2 x 3/8	25
03-1814P	P	1/2 x 3/8	12
03-1815	C	Same as above carded with washers	6
03-1816	B	1-1/4 x 1-1/4	25
03-1816P	P	1-1/4 x 1-1/4	12
03-1819	C	Same as above carded with washer	6
03-1819P	P	Same as above bagged with washer	12
03-1820	B	1-1/4 x 1-3/8 Reducing	25
03-1823	C	Same as above carded with washer	6
03-1824	B	1-1/2 x 1-1/4 Reducing	25
03-1824P	P	1-1/2 x 1-1/4 Reducing	12
03-1827	C	Same as above carded with washer	6
03-1827P	P	Same as above bagged with washer	12
03-1828	B	1-1/2 x 1-3/8 Reducing	25
03-1831	C	Same as above carded with washer	6
03-1832	B	1-1/2 x 1-1/2	25
03-1832P	P	1-1/2 x 1-1/2	12
03-1835	C	Same as above carded with washer	6
03-1835P	P	Same as above bagged with washer	12
03-1836	B	2 x 2	25
03-1836P	P	2 x 2	12
03-1839	C	Same as above carded with washer	6

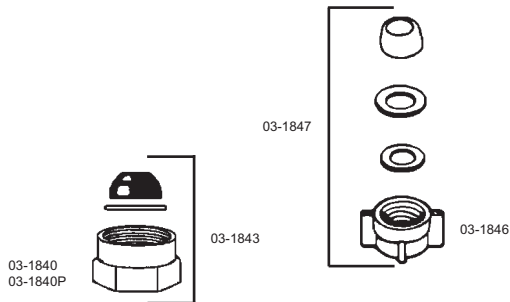
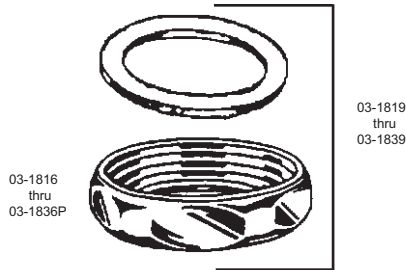

PLASTIC SLIP JOINT NUTS "WHITE"

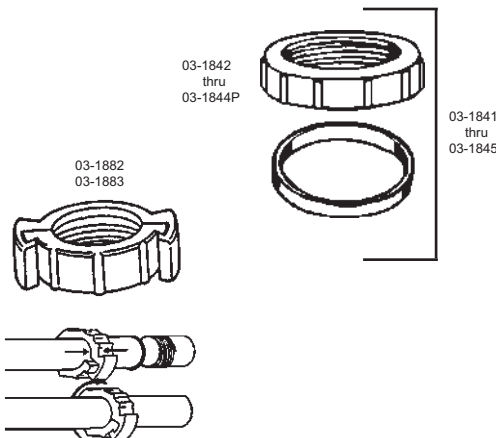

03-1846	B	1/2 x 1/2 Wing style	25
03-1847	C	Same as above carded with washers	6
03-1840	B	5/8 x 1/2 Ballcock	25
03-1840P	P	5/8 x 1/2 Ballcock	12
03-1843	C	Same as above carded with washers	6
03-1842	B	1-1/4 x 1-1/4	25
03-1842P	P	1-1/4 x 1-1/4	12
03-1849	C	Same as above carded with washer	6
03-1844	B	1-1/2 x 1-1/2	25
03-1844P	P	1-1/2 x 1-1/2	12
03-1845	C	Same as above carded with 1-1/2 & 1-1/4 washers	6
03-1845A	C	Same as above carded with tailpiece washer	6
03-1882	B	1-1/2 Split (2 piece) PVC slip joint nut	100
03-1883	C	Same as above carded	6
03-1841	C	1-1/2 x 1-1/2 with washer (Black)	6



SLIP JOINT NUTS

B = BULK
C = CARDED
P = POLY BAG

ITEM NO.	PACK	DESCRIPTION	CTN. QTY.
CHROME PLATED BRASS			
03-1850	B	1/2 x 7/16	25
03-1853	C	Same as above carded with washers	6
03-1854	B	1/2 x 1/2	25
03-1857	C	Same as above carded with washers	6
03-1858	B	1-1/4 x 1-1/4	25
03-1861	C	Same as above carded with washer	6
03-1862	B	1-1/2 x 1-1/4 Reducing	25
03-1865	C	Same as above carded with washer	6
03-1870	B	1-1/2 x 1-1/2	25
03-1873	C	Same as above carded with washer	6
03-1874	B	2 x 2	25
03-1877	C	Same as above carded with washer	6
03-1880	B	5/8 x 1/2 Brass plated ballcock nut	25

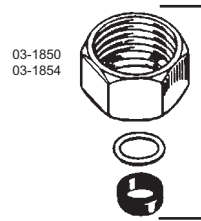

03-1853
03-1857



03-1861
thru
03-1877

03-1858
thru
03-1874



03-1880



03-1889

03-1884
03-1888

ROUGH BRASS

03-1884	B	1-1/2 x 1-1/4	25
03-1888	B	1-1/2 x 1-1/2	25
03-1889	C	Same as above carded with washer	6

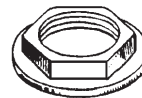

03-1900
thru
03-1803
and
03-1912
thru
03-1918

DIE CAST JAM NUTS

03-1900	B	1/2 IPS	25
03-1900P	P	1/2 IPS	12
03-1903	C	Same as above (2ea in snap pack)	6
03-1907	C	Same as above (1ea nut & flat rosette snap pack)	6
03-1911	C	Same as above (2ea nut & flat rosette snap pack)	6
03-1912	B	5/8 Ballcock	25
03-1916	B	3/4 IPS	25
03-1919	C	Same as above (2ea in snap pack)	6
03-1918	B	1" IPS	25
03-1920	B	1-1/4 Fine thread for PO plug	25
03-1928	B	1-1/4 IPS	25
03-1931	C	Same as above carded	6
03-1961	C	Pop-Up Nut & Seal Kit • Brass	6
03-1932	B	1-1/2 IPS	25
03-1933	C	Same as above carded	6
03-1940	B	2" IPS	25
03-1943	C	Same as above carded	6
03-1947	C	Same as above carded with beveled washer	6
03-1951	C	Same as above carded with spud washer	6
03-1952	B	4" IPS	25
03-1955	C	Same as above carded	6
03-1959	C	Same as above carded with washers	6
03-1964	B	Price Pfister widespread lock nut	25

03-1907
03-1911

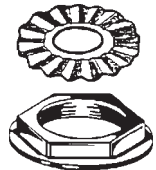

03-1920
thru
03-1943



03-1947
03-1961



03-1951



03-1964

03-1952
03-1955

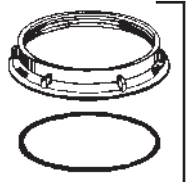

03-1959



B = BULK
C = CARDED
P = POLY BAG

JAM NUTS

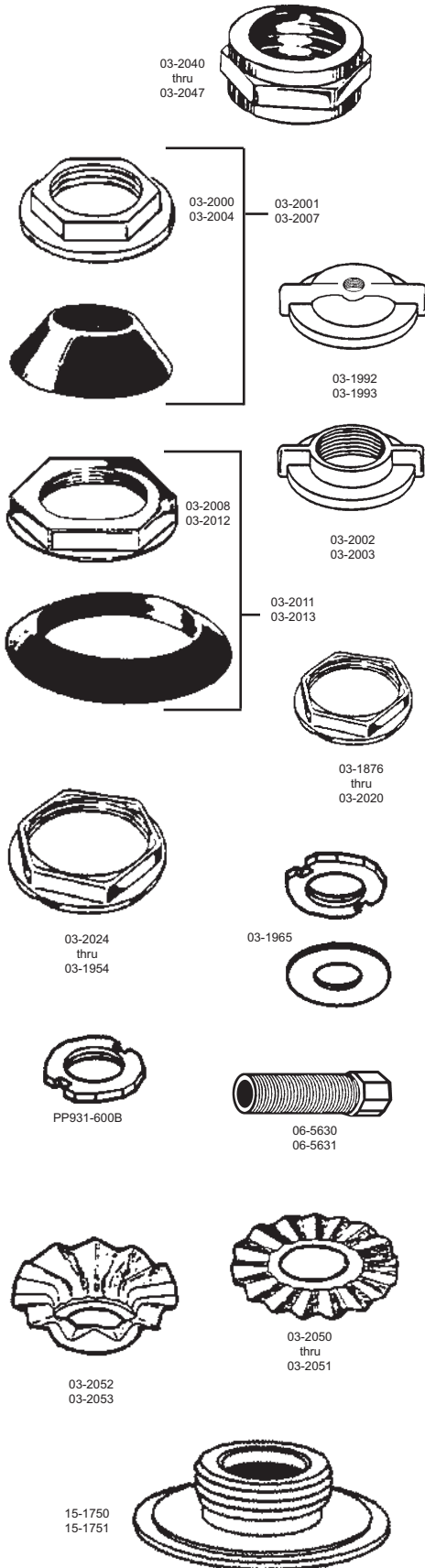

ITEM NO.	PACK	DESCRIPTION	CTN. QTY.
----------	------	-------------	-----------

UNION NUTS

03-2040	B	Chrome plated brass	25
03-2043	C	Same as above carded	6
03-2044	B	Rough brass	25
03-2047	C	Same as above carded	6

PLASTIC JAM NUTS

03-1992	B	3/8 Wing nut for Delta Single Lever	25
03-1993	C	Same as above (2pc in Snap Pack)	6
03-2000	B	1/2 IPS	25
03-2001	C	Same as above (2ea in snap pack)	6
03-2002	B	1/2 IPS Wing Style	25
03-2003	C	Same as above (2ea in snap pack)	6
03-2004	B	5/8 Ballcock	25
03-2007	C	Same as above carded with washer	6
03-2008	B	2" IPS	25
03-2011	C	Same as above carded with washer	6
03-2012	B	4" IPS	25
03-2013	C	Same as above carded with washer	6

BRASS JAM NUTS

PP931-600B	B	PP Widespread Jam Nut	25
03-1965	C	PP Widespread Jam Nut with Nylon Washer	6
03-1876	B	1" IPS Fisher drain plug	25
03-1878	B	1-1/2 IPS Fisher strainer	25
03-2020	B	1-1/4 IPS	25
03-2024	B	1-1/2 IPS	25
03-2025	C	Same as above carded	6
03-2028	B	2" IPS	25
03-2029	C	Same as above carded	6
03-1954	B	4" IPS	25

SHANK EXTENDER

06-5630	B	1/2" x 2-1/2" Shank Extender	1
06-5631	C	Same as above (2 ea in snap pack)	6

ROSETTES

03-2050	B	1/2" Flat	25
03-2050P	P	1/2" Flat	12
03-2051	C	Same as above (2 ea in snap pack)	6
03-2052	B	1/2" Raised	25
03-2053	C	Same as above (2 ea in snap pack)	6

BRASS HOSE TO TRAP ADAPTER
USED TO HOOK UP HOSE TO
SLIP JOINT NUT

15-1750	B	Bulk	12
15-1751	C	Carded	6



BRASS TUBULAR

**B = BULK
C = CARDED**

ITEM NO.	PACK	DESCRIPTION	CTN. QTY.
----------	------	-------------	-----------

SOLDER EXTENSION 20 GAUGE CHROME

03-2530	B	1-1/4 x 6	25
03-2536	B	1-1/4 x 12	25
03-2540	B	1-1/2 x 6	25
03-2546	B	1-1/2 x 12	25

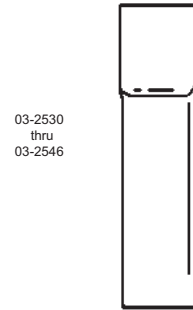

SLIP JOINT EXTENSION 22 GAUGE SATIN

03-2560	B	1-1/4 x 6	25
03-2561	C	Same as above carded	6
03-2562	B	1-1/4 x 8	25
03-2563	C	Same as above carded	6
03-2566	B	1-1/4 x 12	25
03-2567	C	Same as above carded	6
03-2570	B	1-1/2 x 6	25
03-2571	C	Same as above carded	6
03-2572	B	1-1/2 x 8	25
03-2573	C	Same as above carded	6
03-2574	B	1-1/2 x 10	25
03-2575	C	Same as above carded	6
03-2576	B	1-1/2 x 12	25
03-2577	C	Same as above carded	6

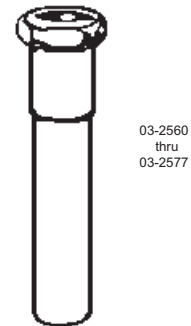

SLIP JOINT EXTENSION 20 GAUGE

03-2590	B	1-1/4 x 6	Chrome Plated	25
03-2592	B	1-1/4 x 8	Chrome Plated	25
03-2596	B	1-1/4 x 12	Chrome Plated	25
03-2620	B	1-1/4 x 16 Double	Chrome Plated	25
03-2600	B	1-1/2 x 6	Chrome Plated	25
03-2602	B	1-1/2 x 8	Chrome Plated	25
03-2606	B	1-1/2 x 12	Chrome Plated	25
03-2622	B	1-1/2 x 16 Double	Chrome Plated	25
03-2610	B	1-1/2 x 6	Rough Brass	25
03-2612	B	1-1/2 x 12	Rough Brass	25

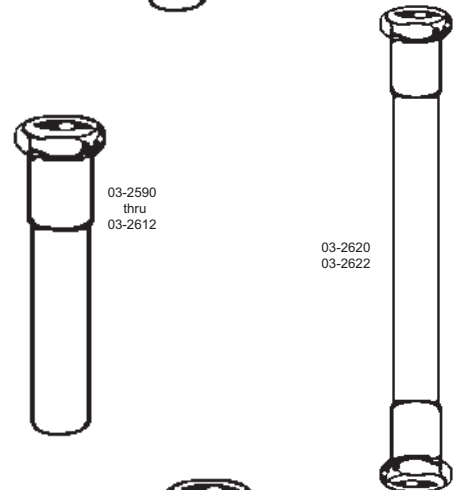

SLIP JOINT EXTENSION 17 GAUGE

03-2632	B	1-1/4 x 6	25
03-2633	C	Same as above carded	6
03-2638	B	1-1/4 x 12	25
03-2639	C	Same as above carded	6
03-2642	B	1-1/2 x 6	25
03-2643	C	Same as above carded	6
03-2648	B	1-1/2 x 12	25
03-2649	C	Same as above carded	6

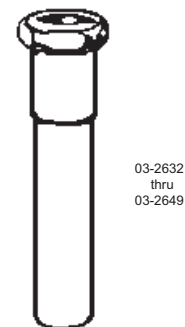

TUBULAR

B = BULK
C = CARDED

BRASS TUBULAR

ITEM NO.	PACK	DESCRIPTION	CTN. QTY.
----------	------	-------------	-----------

TAILPIECE 22 GAUGE SATIN

03-2700	B	1-1/4 x 4	25
03-2701	C	Same as above carded	6
03-2702	B	1-1/4 x 6	25
03-2703	C	Same as above carded	6
03-2704	B	1-1/4 x 8	25
03-2705	C	Same as above carded	6
03-2706	B	1-1/4 x 10	25
03-2708	B	1-1/4 x 12	25
03-2709	C	Same as above carded	6
03-2720	B	1-1/2 x 4	25
03-2721	C	Same as above carded	6
03-2722	B	1-1/2 x 6	25
03-2723	C	Same as above carded	6
03-2724	B	1-1/2 x 8	25
03-2725	C	Same as above carded	6
03-2726	B	1-1/2 x 10	25
03-2728	B	1-1/2 x 12	25
03-2729	C	Same as above carded	6
03-2830	B	1-1/2 x 16 Double	25

TAILPIECE 20 GAUGE CHROME

03-2740	B	1-1/4 x 4	25
03-2742	B	1-1/4 x 6	25
03-2744	B	1-1/4 x 8	25
03-2748	B	1-1/4 x 12	25
03-2760	B	1-1/2 x 4	25
03-2762	B	1-1/2 x 6	25
03-2764	B	1-1/2 x 8	25
03-2766	B	1-1/2 x 10	25
03-2768	B	1-1/2 x 12	25
03-2820	B	1-1/2 x 16 Double	25

TAILPIECE 17 GAUGE CHROME

03-2752	B	1-1/4 x 6	25
03-2753	C	Same as above carded	6
03-2758	B	1-1/4 x 12	25
03-2759	C	Same as above carded	6
03-2772	B	1-1/2 x 6	25
03-2773	C	Same as above carded	6
03-2778	B	1-1/2 x 12	25
03-2779	C	Same as above carded	6
03-3220	B	Hi Line Flanged Tailpiece w/ threads	6
03-2718	B	Hi Line Flanged Tailpiece w/o threads	6

03-2700
thru
03-2709

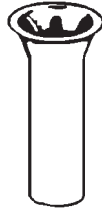

03-2720
thru
03-2729

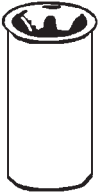

03-2740
thru
03-2748



03-2760
thru
03-2768

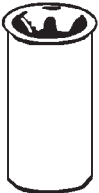

03-2830
03-2720



03-2752
thru
03-2759

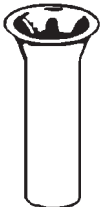

03-2772
thru
03-2779



03-3220

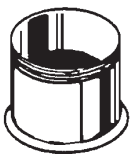

03/22/07



BRASS TUBULAR

B = BULK
C = CARDED
P = POLY BAG

ITEM NO.	PACK	DESCRIPTION	CTN. QTY.
----------	------	-------------	-----------

TAILPIECE 20 GAUGE ROUGH BRASS

03-2800	B	1-1/2 x 4	25
03-2802	B	1-1/2 x 6	25
03-2804	B	1-1/2 x 8	25
03-2806	B	1-1/2 x 10	25
03-2808	B	1-1/2 x 12	25



BRANCH TAILPIECE

03-2836	B	1-1/2x8 SJ Extension • 1/2" Copper (5/8 OD) outlet	25
03-2837	C	Same as above carded	6
03-2840	B	1-1/4x8 SJ Extension • 1/2" Copper (5/8 OD) outlet	25
03-2841	C	Same as above carded	6
03-2854	B	1-1/4x8 SJ Extension • 3/4" Copper (7/8) outlet	25
03-2842	B	1-1/2x8 DC Extension • 1/2" Copper (5/8 OD) outlet	25
03-2843	C	Same as above carded	6
03-2846	B	1-1/2x8 DJ Extension • 3/4" Copper (7/8 OD) outlet	25
03-2847	C	Same as above carded	6
03-2848	B	1-1/2x8 SJ Extension • 3/4 outlet	25
03-2849	C	Same as above carded	6
03-2844	B	1-1/4x8 TOE Extension • 1/2" Copper (5/8 OD) outlet	25
03-2832	B	1-1/4x8 TOE • 3/4 Copper (7/8 OD) outlet	25
03-2850	B	1-1/2x8 TOE • 3/4 Copper (7/8 OD) outlet	25
03-2834	B	1-1/2x8 SJ Extension • Male hose outlet	25
03-2838	B	1-1/2x8 Direct connect • Male hose outlet	25

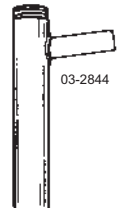
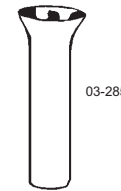
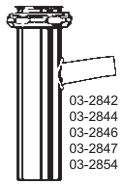
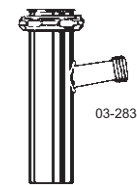
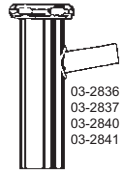
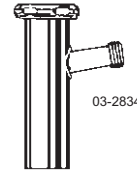

SINK FUNNEL

03-2852	B	1-1/2 x 8	25
---------	---	-----------	----

TRAY WASTE

3-2880	B	16" center outlet waste direct connect satin	15
03-2882	B	16" center outlet waste slip joint satin	15
03-2884	B	16" end outlet direct connect satin	15
03-2886	B	16" end outlet slip joint satin	15
03-2900	B	16" LA Code end outlet waste rough brass	15
03-2900P	P	16" LA Code end outlet waste rough brass	15
03-2901	C	Same as above carded	6
03-2903	C	Same as above carded (22 GAUGE)	6
03-2910	B	16" LA Code center outlet waste rough brass	12
03-2911	C	Same as above carded	6
03-2913	C	Same as above carded (22 GAUGE)	6

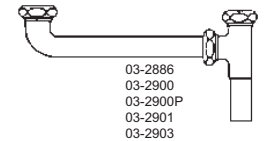
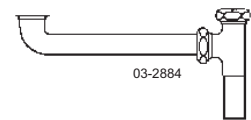
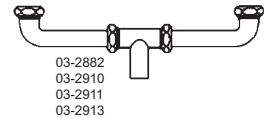
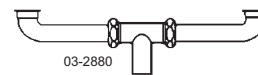

SLIP JOINT OFFSET

03-3282	B	1-1/4 Chrome double offset	25
03-3284	B	1-1/2 Chrome double offset	25

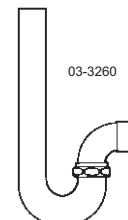
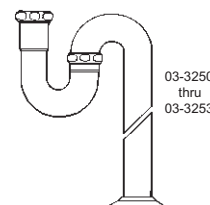

S-TRAP & WASHING MACHINE TRAP W/STAND PIPE

03-3250	B	1-1/4" S-Trap (22 GAUGE)	25
03-3251	C	Same as above carded	1
03-3252	B	1-1/2" S-Trap (22 GAUGE)	25
03-3253	C	Same as above carded	1
03-3260	B	CP 1-1/2" Washing machine trap complete	25
03-3290	B	Stand pipe only.	25
03-3293	C	ABS Stand Pipe Kit Just cut & Glue 2" ABS Pipe to Our ABS Adapter	6

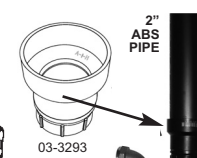
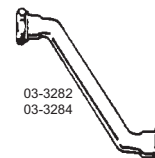

TUBULAR

B = BULK
C = CARDED

BRASS TUBULAR

ITEM NO.	PACK	DESCRIPTION	CTN. QTY.
----------	------	-------------	-----------

WASTE ELL WITH NUT 20 GAUGE ROUGH BRASS

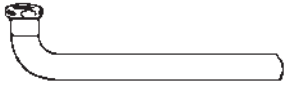

03-2920
thru
03-2930

03-2920	B	7"	25
03-2922	B	9-1/2"	25
03-2924	B	11-1/2"	25
03-2926	B	14"	25
03-2928	B	19"	25
03-2930	B	23"	25

WASTE ELL WITH NUT 22 GAUGE SATIN

03-2940
thru
03-2951

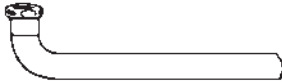

03-2940	B	7"	25
03-2941	C	Same as above carded	6
03-2942	B	9-1/2"	25
03-2943	C	Same as above carded	6
03-2944	B	11-1/2"	25
03-2945	C	Same as above carded	6
03-2946	B	14"	25
03-2947	C	Same as above carded	6
03-2948	B	19"	25
03-2949	C	Same as above carded	6
03-2950	B	23"	25
03-2951	C	Same as above carded	6

WASTE ELL FLANGED 20 GAUGE ROUGH BRASS

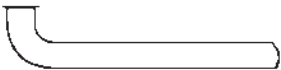

03-2970
thru
03-2980

03-2970	B	7"	25
03-2972	B	9-1/2"	25
03-2974	B	11-1/2"	25
03-2976	B	14"	25
03-2978	B	19"	25
03-2980	B	23"	25

WASTE ELL FLANGED 22 GAUGE SATIN

03-2988
thru
03-2999



03-2988	B	7"	25
03-2989	C	Same as above carded	6
03-2990	B	9-1/2"	25
03-2991	C	Same as above carded	6
03-2992	B	11-1/2"	25
03-2993	C	Same as above carded	6
03-2994	B	14"	25
03-2995	C	Same as above carded	6
03-2996	B	19"	25
03-2997	C	Same as above carded	6
03-2998	B	23"	25
03-2999	C	Same as above carded	6



BRASS TUBULAR

**B = BULK
C = CARDED**

ITEM NO.	PACK	DESCRIPTION	CTN. QTY.
----------	------	-------------	-----------

THREADED TAILPIECES 20 GAUGE SATIN

03-3100	B	1-1/4 x 4	25
03-3101	C	Same as above carded	6
03-3102	B	1-1/4 x 6	25
03-3103	C	Same as above carded	6
03-3104	B	1-1/4 x 8	25
03-3105	C	Same as above carded	6
03-3106	B	1-1/4 x 12	25
03-3107	C	Same as above carded	6
03-3120	B	1-3/8 x 4	25
03-3126	B	1-3/8 x 12	25
03-3127	C	Same as above carded	6
03-3130	B	1-1/2 x 4	25
03-3131	C	Same as above carded	6
03-3132	B	1-1/2 x 6	25
03-3133	C	Same as above carded	6
03-3134	B	1-1/2 x 8	25
03-3135	C	Same as above carded	6
03-3136	B	1-1/2 x 12	25
03-3137	C	Same as above carded	6

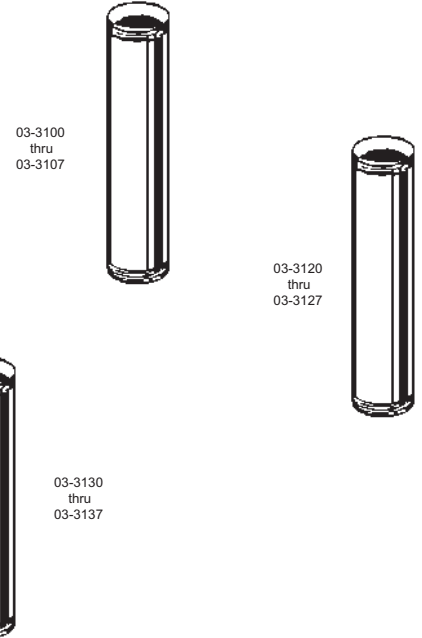

THREADED TAILPIECES 17 GAUGE CHROME

03-3112	B	1-1/4 x 6	25
03-3113	C	Same as above carded	6
03-3118	B	1-1/4 x 12	25
03-3119	C	Same as above carded	6
03-3142	B	1-1/2 x 6	25
03-3143	C	Same as above carded	6
03-3148	B	1-1/2 x 12	25
03-3149	C	Same as above carded	6

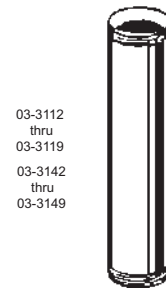

THREADED TAILPIECES 20 GAUGE ROUGH BRASS

03-3150	B	1-1/4 x 4	25
03-3152	B	1-1/4 x 6	25
03-3154	B	1-1/4 x 8	25
03-3156	B	1-1/4 x 12	25
03-3170	B	1-3/8 x 4	25
03-3171	C	Same as above carded	6
03-3176	B	1-3/8 x 12	25
03-3177	C	Same as above carded	6
03-3190	B	1-1/2 x 4	25
03-3192	B	1-1/2 x 6	25
03-3194	B	1-1/2 x 8	25
03-3196	B	1-1/2 x 12	25

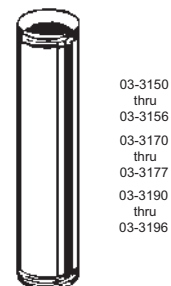

TUBULAR

B = BULK
C = CARDED
P = POLY BAG

BRASS TUBULAR

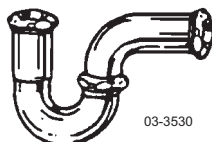
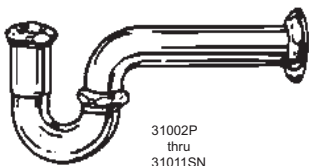
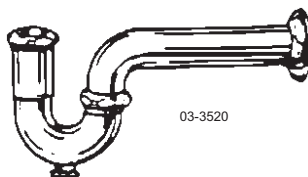
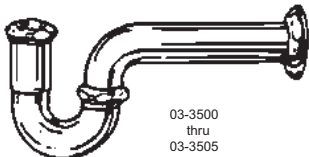
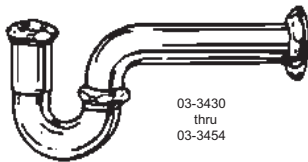
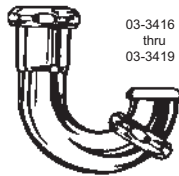
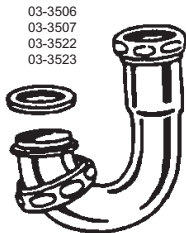
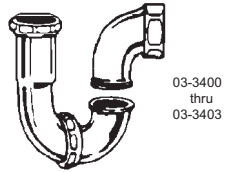

ITEM NO.	PACK	DESCRIPTION	CTN. QTY.
----------	------	-------------	-----------

LA PATTERN TRAPS

03-3400	B	1-1/2 17 Gauge rough brass	25
03-3401	C	Same as above carded	6
03-3402	B	1-1/2 x 1-1/4 17 Gauge chrome	25
03-3403	C	Same as above carded	6

LA PATTERN TRAP PARTS

03-3412	B	1-1/2 Elbow only chrome	25
03-3416	B	1-1/2 J-Bend only 17 gauge rough brass	25
03-3417	C	Same as above carded	6
03-3418	B	1-1/2 x 1-1/4 Choke J-Bend only 17 gauge chrome	25
03-3419	C	Same as above carded	6
03-3506	B	1-1/2 Beaded Captive nut J-Bend only 22ga sat	25
03-3507	C	Same as above carded	6
03-3522	B	1-1/4 Beaded Captive nut J-Bend only 22 ga sat	25
03-3523	C	Same as above carded	6

P-TRAPS

03-3434	B	1-1/4 17 Gauge chrome	25
03-3435	C	Same as above carded	6
03-3430	B	1-1/2 17 Gauge chrome	25
03-3431	C	Same as above carded	6
03-3432	B	1-1/2 x 1-1/4 Choke 17 Gauge chrome	25
03-3433	C	Same as above carded	6
03-3454	B	1-1/4 20 Gauge chrome	25
03-3450	B	1-1/2 20 Gauge chrome	25
03-3452	B	1-1/2 x 1-1/4 Choke 20 Gauge chrome	25
03-3504	B	1-1/4 x 1-1/4 22 Gauge satin	25
03-3504P	P	1-1/4 x 1-1/4 22 Gauge satin	12
03-3505	C	Same as above carded	6
03-3500	B	1-1/2 22 Gauge satin	25
03-3500P	P	1-1/2 22 Gauge satin	12
03-3501	C	Same as above carded	6
03-3502	B	1-1/2 x 1-1/4 Choke 22 Gauge satin	25
03-3502P	P	1-1/2 x 1-1/4 22 Gauge satin	12
03-3503	C	Same as above carded	6
31002SN	P	1-1/4 Satin Nickel	12
31003SN	C	Same as above carded	6
31010SN	P	1-1/2 Satin Nickel	12
31011SN	C	Same as above carded	6
03-3520	B	1-1/2 With clean out 20 gauge chrome	25
03-3530	B	1-1/2 Quick replacement satin	25
31002P	P	1-1/4 Polished brass	12
31003P	C	Same as above carded	6
31010P	P	1-1/2 Polished brass	12
31011P	C	Same as above carded	6



BRASS TUBULAR

B = BULK
C = CARDED
P = POLY BAG

ITEM NO.	PACK	DESCRIPTION	CTN. QTY.
TUBING J-BENDS			
03-3442	B	1-1/4 17 Gauge chrome	25
03-3443	C	(Same as above carded)	6
03-3438	B	1-1/2 17 Gauge chrome	25
03-3439	C	(Same as above carded)	6
03-3440	B	1-1/2 x 1-1/4 Choke 17 Gauge chrome	25
03-3441	C	(Same as above carded)	6
03-3466	B	1-1/4 20 Gauge chrome	25
03-3462	B	1-1/2 20 Gauge chrome	25
03-3464	B	1-1/2 x 1-1/4 20 Gauge chrome	25
03-3470	B	1-1/2 or 1-1/4 Choke 20 Gauge chrome Ground Joint	25
03-3471	C	(Same as above carded)	6
03-3516	B	1-1/4 22 Gauge satin	25
03-3516P	P	1-1/4 22 Gauge	12
03-3517	C	(Same as above carded)	6
03-3512	B	1-1/2 22 Gauge satin	25
03-3512P	P	1-1/2 22 Gauge satin	12
03-3513	C	(Same as above carded)	6
03-3514	B	1-1/2 x 1-1/4 Choke 22 Gauge satin	25
03-3514P	P	1-1/2 x 1-1/4 Choke 22 Gauge satin	12
03-3515	C	(Same as above carded)	6
03-3508	B	1-1/2 Hi Inlet 22 Gauge satin	25
03-3509	C	(Same as above carded)	6
03-3528	B	1-1/2 x 1-1/4 Choke Hi Inlet 22 Gauge satin	25
03-3529	C	(Same as above carded)	6
03-3444	B	1-1/2 Low Inlet J-Bend 20 Gauge	25
03-3445	C	(Same as above carded)	6

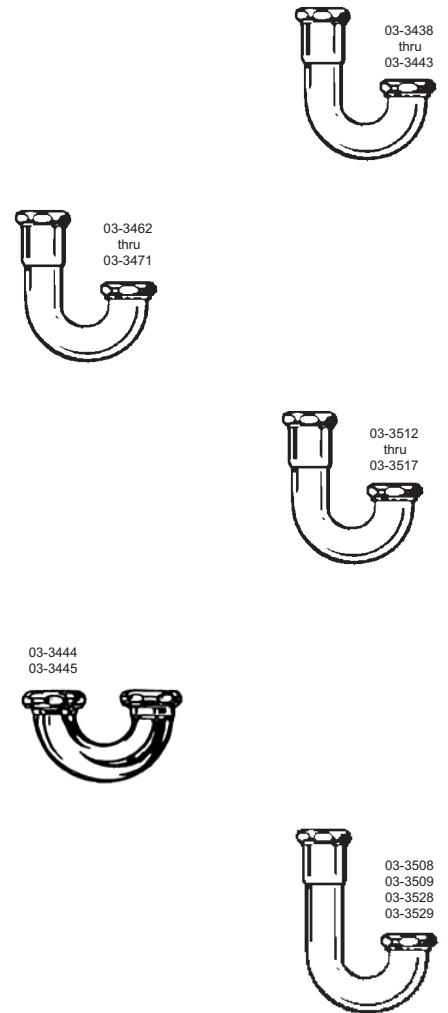

WALL BENDS

03-3436	B	1-1/2 17 Gauge chrome	25
03-3460	B	1-1/2 20 Gauge chrome	25
03-3458	B	1-1/4 22 Gauge satin	25
03-3459	C	(Same as above carded)	6
03-3548	B	1-1/4 x 15 22 Gauge satin	25
03-3549	C	(Same as above carded)	6
03-3510	B	1-1/2 22 Gauge satin	25
03-3511	C	(Same as above carded)	6
03-3550	B	1-1/2 x 12 22 Gauge satin	25
03-3551	C	(Same as above carded)	6
03-3552	B	1-1/2 x 15 22 Gauge satin	25
03-3553	C	(Same as above carded)	6
03-3554	B	1-1/2 x 18 22 gauge satin	25
03-3555	C	(Same as above carded)	6
03-3558	B	1-1/4" Quick repair ell (AZ Warehouse)	25
03-3560	B	1-1/2" Quick repair ell	25
03-3561	C	(Same as above carded)	6

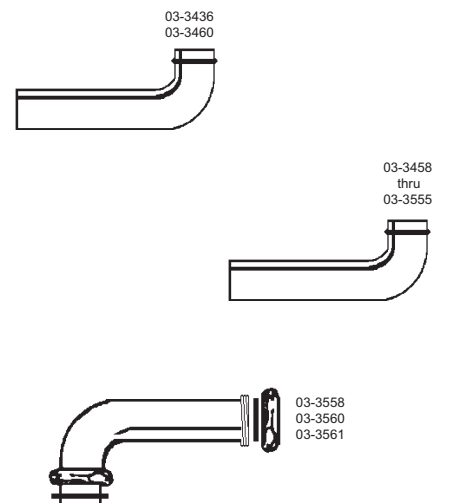

TUBULAR

B = BULK
C = CARDED

BRASS TUBULAR

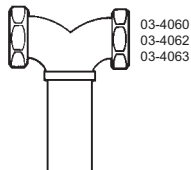
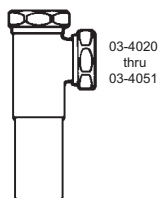
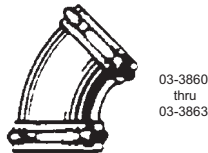
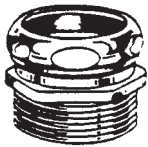
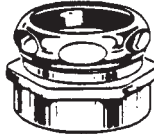
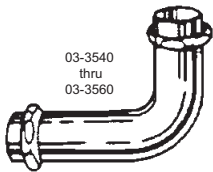
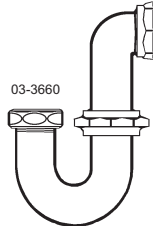
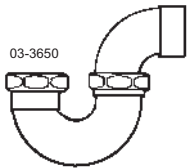
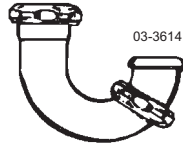
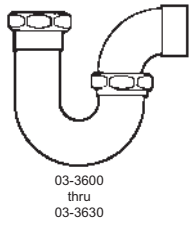

ITEM NO.	PACK	DESCRIPTION	CTN. QTY.
----------	------	-------------	-----------

CAST BRASS TRAPS

03-3600	B	1-1/2 Regular rough brass	25
03-3602	B	1-1/2 Regular chrome	25
03-3614	B	1-1/2 J-Bend only rough brass	25
03-3630	B	1-1/2 Regular import rough brass	25
03-3650	B	1-1/2 Low rough brass	25
03-3660	B	1-1/2 Extra low rough brass	25

FLUSH ELL

03-3540	B	2 x 4 x 6 Chrome	25
03-3542	B	2 x 5 x 7 Chrome	25
03-3543	C	Same as above carded	6
03-3544	B	2 x 6 x 8 Chrome	25

WASTE CONNECTORS

03-3800	B	1-1/4 Male x 1-1/4 SJ rough brass	25
03-3802	B	1-1/2 Male x 1-1/2 SJ rough brass	25
03-3804	B	1-1/2 Male x 1-1/4 SJ rough brass	25
03-3810	B	1-1/4 Female x 1-1/4 SJ rough brass	25
03-3812	B	1-1/2 Female x 1-1/2 SJ rough brass	25
03-3814	B	1-1/2 Female x 1-1/4 SJ rough brass	25
03-3840	B	1-1/4 x 1-1/4 Slip collar	25
03-3842	B	1-1/2 x 1-1/2 Slip collar	25

CHROME PLATED BRASS FITTINGS

03-3850	B	1-1/4 Slip joint 90° ell	25
03-3851	C	Same as above carded	6
03-3852	B	1-1/2 Slip joint 90° ell	25
03-3853	C	Same as above carded	6
03-3860	B	1-1/4 Slip joint 45° ell	25
03-3861	C	Same as above carded	6
03-3862	B	1-1/2 Slip joint 45° ell	25
03-3863	C	Same as above carded	6
03-3870	B	1-1/4 Slip joint coupling	25
03-3871	C	Same as above carded	6
03-3872	B	1-1/2 Slip joint coupling	25
03-3873	C	Same as above carded	6
03-4010	B	1-1/2 Slip joint tee	25
03-4011	C	Same as above carded	6

DISPOSAL TEES

03-4020	B	1-1/2 With baffle rough brass	12
03-4021	C	Same as above carded	6
03-4040	B	1-1/2 Less baffle rough brass	12
03-4041	C	Same as above carded	6
03-4050	B	1-1/2 Tubing style chrome	12
03-4051	C	Same as above carded	6
03-4062	B	1-1/2 Center outlet with baffle rough brass	12
03-4063	C	Same as above carded	6
03-4060	B	1-1/2 Center outlet tee	12



WHITE PLASTIC TUBULAR

B = BULK
C = CARDED
P = POLY BAG

ITEM NO.	PACK	DESCRIPTION	CTN. QTY.
----------	------	-------------	-----------

TELESCOPIC KITS

03-4107	C	1-1/2 Disposer kit	6
03-4215	C	16" End outlet waste	6
03-4207	C	Disposal connector kit	6

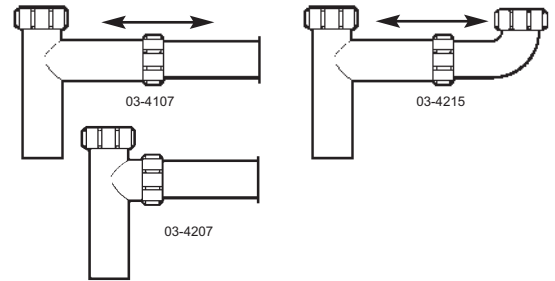

TRAY WASTE

03-4200P	P	16" End outlet	12
03-4201	C	(Same as above carded)	6
03-4208P	P	16" Center outlet	12
03-4209	C	(Same as above carded)	6



P-TRAPS

03-4210P	P	1-1/4 x 1-1/4	24
03-4211	C	(Same as above carded)	6
03-4211C	C	1-1/4 x 1-1/4 • Chrome Plated	6
03-4212	B	1-1/2 x 1-1/2 or 1-1/4 (W/1-1/2 Marvel adapter)	25
03-4212P	P	1-1/2 x 1-1/2 or 1-1/4	24
03-4213	C	(Same as above carded)	6
03-4213C	C	1-1/2 x 1-1/2 or 1-1/4 • Chrome Plated	6
03-4228P	P	LA Pattern Reverse nut x Slip Joint	12
03-4229	C	(Same as above carded)	6
03-4230P	P	Repair trap Slip Joint x Slip Joint	12
03-4231	C	(Same as above carded)	6
03-4338	B	1-1/4 S-Trap	25
03-4339	C	(Same as above carded)	6
03-4334	B	1-1/2 S-Trap	25
03-4335	C	(Same as above carded)	6
03-4336	B	Washing machine trap with overflow pipe	25
03-4337	C	(Same as above carded)	6
03-4237	C	1-1/2 Hub x 1-1/2 Slip joint trap	6

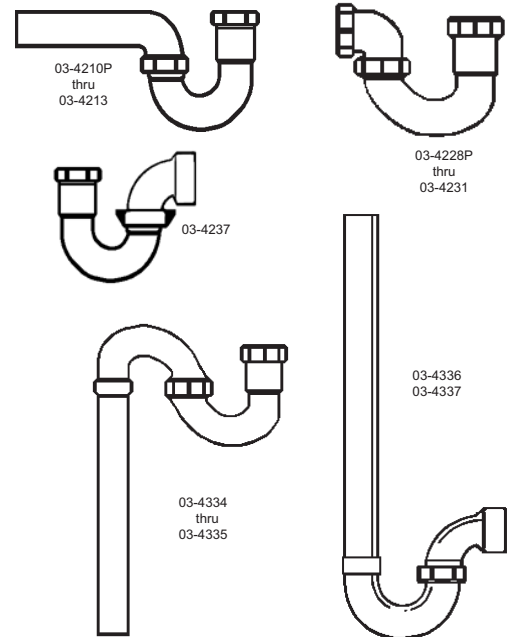

J-BENDS

03-4223	C	1-1/4 x 1-1/4	6
03-4220P	P	1-1/2 x 1-1/2 or 1-1/4	24
03-4221	C	(Same as above carded)	6
03-4224	B	1-1/2 Flexi J-Bend	25
03-4224P	P	1-1/2 Flexi J-Bend	12
03-4225	C	(Same as above carded)	6
03-4227	C	LA Pattern Reverse nut x Slip Joint	6
03-4235	C	1-1/2 Flexi P-Trap	6

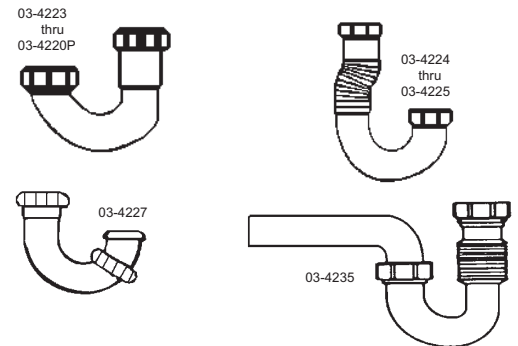

TRAP ADAPTERS

03-4252	B	1-1/2 Marvel adapter	25
03-4253	C	(Same as above carded)	6
03-4251	C	1-1/4 OD x 1-1/2 White w/ solvent weld	6
03-4299	C	1-1/4 x 1-1/2 Marvel Adapter	6
		1-1/4 Solvant x 1-1/2 Slip joint	



TUBULAR

B = BULK
C = CARDED

WHITE PLASTIC TUBULAR

ITEM NO.	PACK	DESCRIPTION	CTN. QTY.
----------	------	-------------	-----------

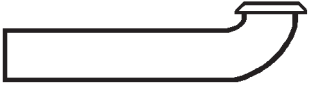

03-4217
03-4219
03-4219A

WALL BEND

03-4217	C	1-1/4 Wall bend only	6
03-4219	C	1-1/2 Wall bend only	6
03-4219A	C	1-1/2 Wall bend ABS for ISE Disposal	6

03-4240
thru
03-4245

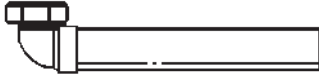

WASTE ELLS

03-4240	B	7" With nut	25
03-4241	C	Same as above carded	6
03-4242	B	9" With nut	25
03-4243	C	Same as above carded	6
03-4244	B	15" With nut	25
03-4245	C	Same as above carded	6
03-4248	B	7" Flanged	25
03-4249	C	Same as above carded	6
03-4258	B	15" Flanged	25
03-4259	C	Same as above carded	6



03-4248
thru
03-4259

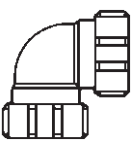

03-4260
03-4261



03-4266
03-4267

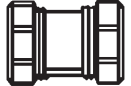

03-4270
03-4271

ELBOWS, COUPLINGS, TEES

03-4260	B	1-1/2 Slip joint 90° ell	25
03-4261	C	Same as above carded	6
03-4266	B	1-1/2 Slip joint 45° ell	25
03-4267	C	Same as above carded	6
03-4270	B	1-1/2 Slip joint coupling	25
03-4271	C	Same as above carded	6
03-4276	B	1-1/2 Slip joint tee	25
03-4277	C	Same as above carded	6
03-4280	B	Disposal tee with tail	25
03-4281	C	Same as above carded	6
03-4290	B	Center outlet tee with tail	25
03-4291	C	Same as above carded	6
03-4354	B	Flexi connector	25
03-4355	C	Same as above carded	6
03-4860	B	1-1/2 Reverse nut 90° ell	25
03-4863	C	Same as above carded	6
03-4263	C	1-1/2 Reverse nut x SJ 90° ell	6

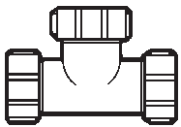

03-4276
03-4277

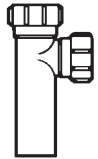

03-4280
03-4281

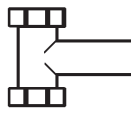

03-4290
03-4291



03-4354
03-4355



03-4860
03-4863
03-4263

TAIL PIECES

03-4300	B	1-1/2 x 4	25
03-4301	C	Same as above carded	6
03-4302	B	1/1/2 x 6	25
03-4303	C	Same as above carded	6
03-4303C	C	1/1/2 x 6 • Chrome plated	6
03-4304	B	1-1/2 x 8	25
03-4305	C	Same as above carded	6
03-4306	B	1-1/2 x 12	25
03-4307	C	Same as above carded	6
03-4307C	C	1-1/2 x 12 • Chrome plated	6
03-4310	B	1-1/2 x 16 double tail piece	25
03-4311	C	Same as above carded	6
03-4308	B	1-1/2 Hi Line tail piece	25



03-4300
thru
03-4307



03-4310
03-4311

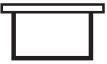

03-4308



WHITE PLASTIC TUBULAR

B = BULK
C = CARDED

ITEM NO.	PACK	DESCRIPTION	CTN. QTY.
----------	------	-------------	--------------

EXTENSION PIECES

03-4315	C	1-1/4 Flexi slip joint	6
03-4317	C	1-1/2 Flexi direct connect	6
03-4318	B	1-1/2 Flexi slip joint	25
03-4319	C	Same as above carded	6
03-4340	B	1-1/4 x 6 Slip joint	25
03-4341	C	Same as above carded	6
03-4342	B	1-1/4 x 8 Slip joint	25
03-4343	C	Same as above carded	6
03-4344	B	1-1/4 x 12 Slip joint	25
03-4345	C	Same as above carded	6
03-4346	B	1-1/4 x 16 Double slip joint	25
03-4347	C	Same as above carded	6
03-4320	B	1-1/2 x 6 Slip joint	25
03-4321	C	Same as above carded	6
03-4321C	C	1-1/2 x 6 Chrome plated	6
03-4322	B	1-1/2 x 8 Slip joint	25
03-4323	C	Same as above carded	6
03-4324	B	1-1/2 x 12 Slip joint	25
03-4325	C	Same as above carded	6
03-4325C	C	1-1/2 x 12 Chrome plated	6
03-4326	B	1-1/2 x 16 Double slip joint	25
03-4327	C	Same as above carded	6

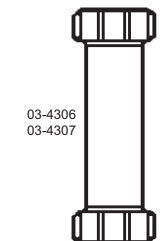
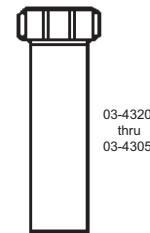
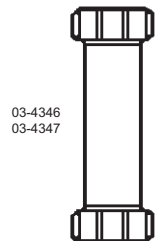
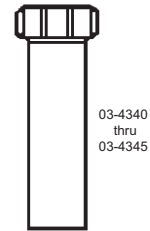
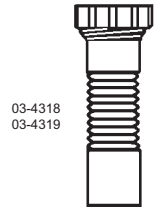
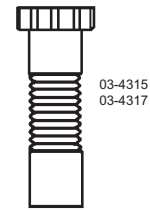

BRANCH TAIL PIECE

03-4350	B	1-1/2 x 8 Direct connect • 5/8 Outlet	25
03-4351	C	Same as above carded	6
03-4330	B	1-1/2 x 8 Direct connect • 7/8 Outlet	25
03-4331	C	Same as above carded	6
03-4332	B	1-1/2 x 8 Slip joint • 7/8 Outlet	25
03-4333	C	Same as above carded	6

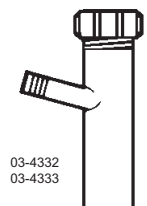
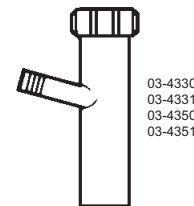

TUBULAR

B = BULK
C = CARDED
P = POLY BAG

BLACK PLASTIC TUBULAR

ITEM NO.	PACK	DESCRIPTION	CTN. QTY.
----------	------	-------------	-----------

TRAPS

03-4202P	P	1-1/2 x 1-1/2 or 1-1/4 P-Trap	24
03-4203	C	Same as above carded	6
03-4233	C	1-1/2 Hub x S.J. W/ female iron pipe adapter	6

TRAY WASTE

03-4204P	P	16" End outlet	12
03-4205	C	Same as above carded	6
03-4206	B	16" Center outlet	25
03-4207A	C	Same as above carded	6

WASTE ELLS

03-4246	B	15" Slip joint	25
03-4247	C	Same as above carded	6
03-4256	B	20" Slip joint	25
03-4257	C	Same as above carded	6
03-4254	B	15" Direct connect	25
03-4255	C	Same as above carded, with nut	6

DISPOSAL TEES

03-4282	B	1-1/2 Disposal tee with tail	25
03-4283	C	Same as above carded	6
03-4292	B	1-1/2 Center outlet with tail	25
03-4293	C	Same as above carded	6

TAIL PIECE

03-4312	B	1-1/2 x 6	25
03-4313	C	Same as above carded	6
03-4348	B	1-1/2 x 12	25
03-4349	C	Same as above carded	6
03-4316	B	1-1/2 x 16 Double	25
03-4317A	C	Same as above carded	6

EXTENSION PIECE

03-4360	B	1-1/2 x 6 Slip joint	25
03-4361	C	Same as above carded	6
03-4364	B	1-1/2 x 12 Slip joint	25
03-4365	C	Same as above carded	6
03-4362	B	1-1/2 x 16 Double slip joint	25
03-4363	C	Same as above carded	6

BRANCH TAIL PIECE

03-4328	B	1-1/2 x 8 Direct connect • 7/8 Outlet	25
03-4329	C	Same as above carded	6

INSTALLATION KITS

03-4400P	P	Kitchen sink kit	12
03-4402P	P	Vanity sink kit	24
25-3931	B	1-1/2 Black slip joint nut	100
03-1841	C	Same as above carded with washer	6

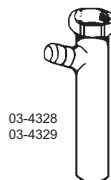
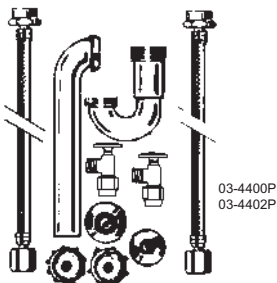
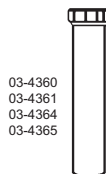
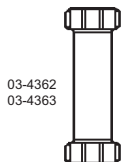
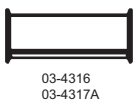
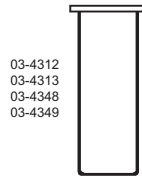
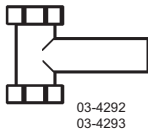
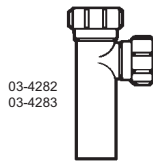
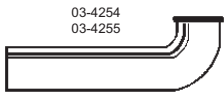
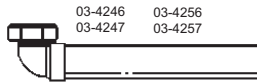
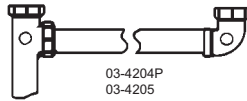
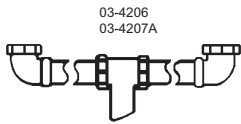
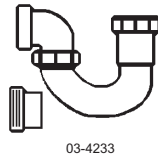
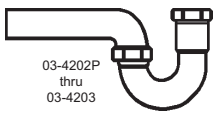

BRASS TUBULAR

**B = BULK
C = CARDED
P = POLY BAG**

ITEM NO.	PACK	DESCRIPTION	CTN. QTY.
P.O. PLUGS 2 PIECE			
03-4500	B	5" 22 Gauge chrome	25
03-4501	C	Same as above carded	6
03-4502	B	6" 22 Gauge chrome	25
03-4503	C	Same as above carded	6
03-4504	B	8" 22 Gauge chrome	25
03-4505	C	Same as above carded	6
03-4508	B	12" 22 Gauge chrome	25
03-4509	C	Same as above carded	6
03-4510	B	5" 20 Gauge chrome	25
03-4511	C	Same as above carded	6
03-4512	B	6" 20 Gauge chrome	25
03-4513	C	Same as above carded	6
P.O. PLUGS 1 PIECE			
03-4520	B	5" 22 Gauge chrome	25
03-4521	C	Same as above carded	6
03-4522	B	8" 22 Gauge chrome	25
03-4523	C	Same as above carded	6
03-4540	B	5" 20 Gauge chrome NO - CLOG	25
03-4544	B	8" 20 Gauge chrome NO - CLOG	25
C.O. PLUGS (NO OVERFLOW HOLES)			
03-4570	B	5" 1-Piece 22 gauge chrome	25
03-4571	C	Same as above carded	6
03-4580	B	5" 1-Piece plastic • Push-Pull	25
03-4581	C	Same as above carded	6
RV254	P	Same as above poly bagged	6
RV253	P	Stopper only for RV254 poly bagged	6
GRID DRAIN PLUG			
03-4600	B	6" Cast brass grid strainer	25
03-4601	C	Same as above carded	6
TIP TOE BASIN DRAIN			
03-4602	B	Tip toe pop-up • No holes	25
03-4603	C	Same as above carded	6
03-4608	B	Tip toe pop-up • With holes	25
03-4609	C	Same as above carded	6
03-4614	B	Tip toe H.D. vessel pop-up	25
03-4615	C	Same as above carded	6
RESTAURANT DRAINS			
03-1104	B	1 x 4 Drain Waste Socket RB	1
03-1106	B	1½ RB Drain	1
03-1140	B	1" Sink Stand Pipe	1
03-1142	B	1½" Sink Stand Pipe	1
03-1144	B	1" Sink Strainer	1
03-1146	B	1½" Sink Strainer	1



03-4500
thru
03-4509

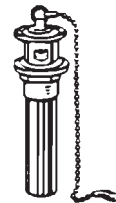

03-4520
thru
03-4523

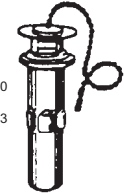

03-4510
thru
03-4513



03-4570
03-4571



03-4540
03-4544

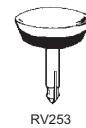

RV253



03-4580
03-4581
RV254



03-4602
thru
03-4609

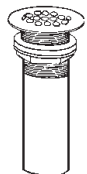

03-4600
03-4601



03-4614
03-4615



03-1140
03-1142



03-1104
03-1106



03-1144
03-1146



TUBULAR

POP - UPS

B = BULK
C = CARDED
P = POLY BAG

ITEM NO.	PACK	DESCRIPTION	CTN. QTY.
----------	------	-------------	-----------

POP - UP ASSEMBLY

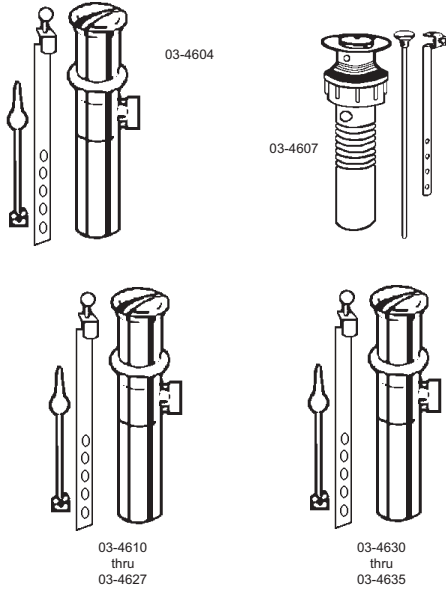

03-4604	B	Delta	3
03-4607	C	Plastic flexi type	6
03-4610	B	Plastic less ports	25
RV251	P	Same as above poly bagged	6
03-4613	C	Moen style 1/2 plastic 1/2 brass	6
03-4620	B	Chrome plated brass	25
03-4620P	P	Chrome plated brass	24
03-4621	C	Same as above carded	6
03-4622	B	Antique bronze	25
03-4623	C	Same as above carded	6
03-4624	B	Polished brass	25
03-4625	C	Same as above carded	6
03-4627	C	Satin Nickel	6
03-4629	C	Oil rubbed bronze	6
03-4630	B	Plastic	25
03-4630P	P	Plastic	24
03-4631	C	Same as above carded	6
03-4633	C	Plastic antique bronze	6
03-4635	C	Plastic polished brass	6

POP - UP WASHERS 0.062"

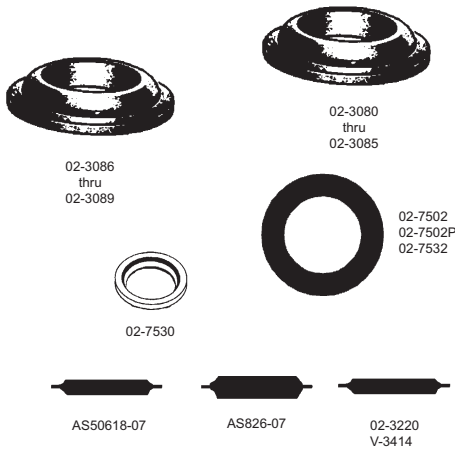

02-3080	B	G-1 1-1/4 Mack gasket	12
02-3081	C	Same as above carded	6
02-3082	B	G-1A 1-1/4 Mack gasket extra wide	12
02-3082P	P	G-1A 1-1/4 Mack gasket extra wide	12
02-3083	C	Same as above carded	6
02-3084	B	G-2 1-5/16 Mack gasket	12
02-3085	C	Same as above carded	6
02-3086	B	G-3 1-3/8 Mack gasket	12
02-3086P	P	G-3 1-3/8 Mack gasket	12
02-3087	C	Same as above carded	6
02-3088	B	G-4 1-1/2 Mack gasket	12
02-3088P	P	G-4 1-1/2 Mack gasket	12
02-3089	C	Same as above carded	6
02-7502	B	Nylon pop-up washer	12
02-7502P	P	Nylon pop-up washer	12
02-7532	B	Pop-Up Flange Washer	12
02-7530	B	Nylon Horz. Rod Seal Washer	12
03-2020	B	1-1/4 Brass jam nut	100
03-4664P	P	1-1/4 Brass jam nut	12
03-1924	B	Die cast pop-up nut fits Price Pfister and Gerber	100
03-1961	C	Same as above carded	6

AS50618-07	B	American Standard 50618-07 thin stopper gasket	1
AS826-07	B	American Standard 826-07 thick stopper gasket	1
02-3220	B	Delta 3016 stopper gasket	12
V-3414	B	Valley stopper gasket	1

HORIZONTAL POP-UP ROD NUTS

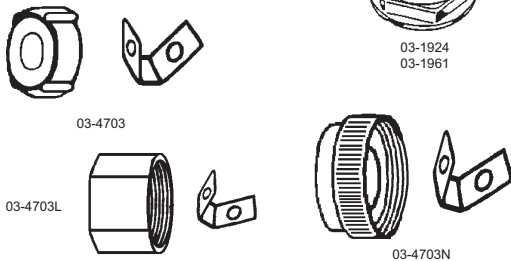

03-4703	C	Price Pfister Rod Clip and Nut	6
03-4703L	C	Price Pfister Plastic Deep Nut Only	6
03-4703N	C	Price Pfister Brass Nut Only	6



POP-UP PARTS

B = BULK
C = CARDED
P = POLY BAG

ITEM NO.	PACK	DESCRIPTION	CTN. QTY.
POP-UP STOPPERS			
0-3041	C	Fit-All stopper 1-3/8 O.D. head	6
0-3041L	C	Fit-All stopper over size head	6
0-3041LP	C	Fit-All stopper over size head Polished Brass	6
03-4643	C	American standard 70460-06 plastic stopper	6
AS25854-09	B	American standard 25854-09 metal stopper	1
0-3039	C	Delta 5648 stopper	6
03-4645	C	Gerber 97-731 stopper	6
03-4639	C	Harcraft • Streamway • Valley	6
03-4649	C	Kohler 30124 stopper	6
03-4647N	C	Moen N/S 10709 stopper	6
03-4647	C	Moen 10727 stopper	6
03-4647L	C	Moen stopper 4-7/8" long	6
03-4653	C	Sayco stopper SA54-58	1
03-4641	C	Sterling A-8372 stopper	6
03-4651	C	Valley V3416 stopper	6

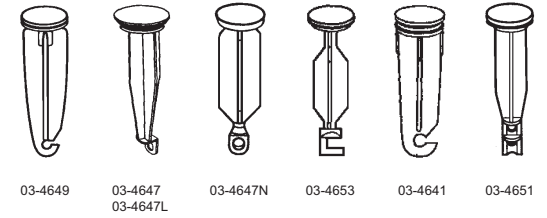
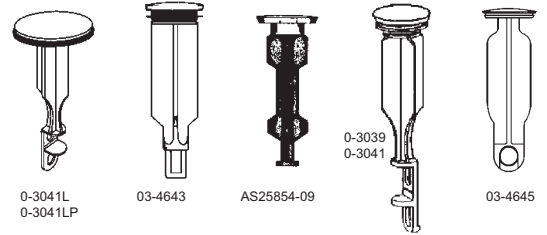

PRICE PFISTER POP-UP STOPPERS

0-2045	C	Chrome Price Pfister top flange	6
0-2045N	C	Antique bronze Price Pfister top flange	6
0-2045P	C	Polished brass Price Pfister top flange	6
20201PDV	C	PDV Price Pfister top flange	6
0-2051	C	Chrome plated brass Price Pfister stopper	6
0-2053	C	Chrome plated plastic Price Pfister stopper	6
0-2047	C	Polished brass plastic Price Pfister stopper	6
0-2049	C	Antique bronze plastic Price Pfister stopper	6
20151PDV	C	PDV Price Pfister stopper	6
0-2053L	C	Chrome Price Pfister big head stopper	6
0-2049L	C	Polished brass Price Pfister big head stopper	6
03-4655	C	Chrome stopper, flange and rod	6
03-4657	C	Antique bronze stopper, flange and rod	6
03-4659	C	Polished brass stopper, flange and rod	6

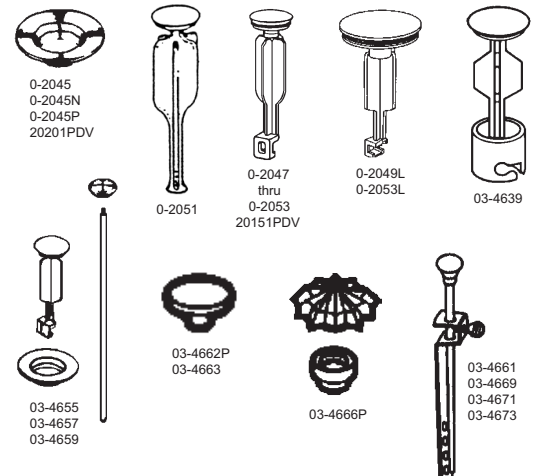

POP-UP RODS

03-4661	C	Delta Rod and strap assembly	6
03-4669	C	Price Pfister rod and strap assembly	6
03-4671	C	Price Pfister rod and strap assembly Extra long	6
03-4673	C	Price Pfister windsor rod and strap assembly	6
03-4662P	P	Price Pfister chrome knob only	12
03-4663	C	Same as above carded	6
03-4666P	P	Price Pfister windsor knob only (2 pieces)	12

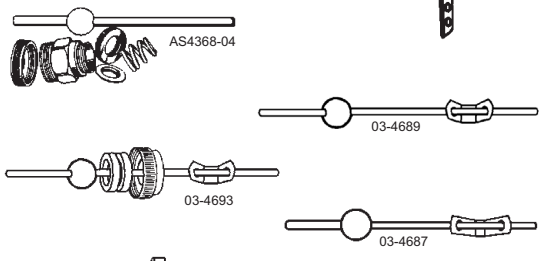

HORIZONTAL POP-UP RODS

AS4368-04	B	American Standard	1
03-4689	C	Delta	6
03-4693	C	Gerber	6
03-4683	C	Moen 11985 rod with nut	6
03-4685	C	Moen 12689	6
03-4697	C	Price Pfister rod clip and nut	6
03-4697L	C	Price Pfister rod clip and nut Ex Long 10"	6
03-4695	C	Sayco	6
03-4691	C	Plastic (IMPORT)	6
03-4699	C	Fit Most 3-ball	6
03-4687	C	Valley V3406	6
03-4676	B	Extension for horz or pop up rod 6"	10

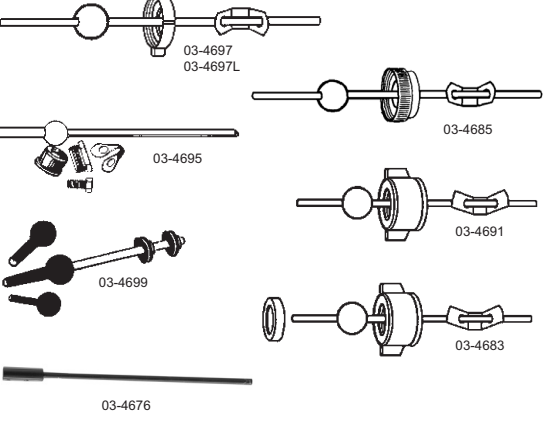

BATH TUB PARTS

B = BULK
C = CARDED
P = POLY BAG

ITEM NO.	PACK	DESCRIPTION	CTN. QTY.
----------	------	-------------	-----------

WASTE AND OVERFLOWS

03-4922	B	Trip waste and overflow 20 gauge	12
03-4923	C	Same as above carded	1
03-4928	B	Trip waste and overflow 17 gauge	12
03-4956	B	Trip waste and overflow PVC	12
03-4957	C	Same as above carded	1
03-4980	B	Same as above with Condensate	12
03-4958	B	Trip waste and overflow ABS	12
03-4958P	P	Trip waste and overflow ABS	1
03-4959	C	Same as above carded	1
03-4918	B	Cabel drive waste and overflow	12
03-4920	B	Toe lift waste and overflow brass	12
03-4954	B	Toe lift waste and overflow plastic	12
03-4954P	P	Toe lift waste and overflow plastic	1
03-4955	C	Same as above carded	1
03-4970	B	Lift and Turn PVC	12
03-4971	C	Same as above carded	6
03-4924	B	1-3/8 Waste and overflow 20 gauge all Chrome	12
03-4926	B	1-1/2 Waste and overflow 20 gauge RB	12
03-4930	B	1-1/2 Waste and overflow 20 gauge all Chrome	12
03-4941	C	Chrome plated closure assembly ABS	1
03-4943	C	Satin Nickel closure assembly ABS	1
03-4945	C	Polished brass closure assembly ABS	1
03-4947	C	Chrome plated closure assembly PVC	1
03-4950	B	Stopper with waste ell ABS	1
03-4952	B	Stopper with straight waste ABS	1
03-4948	B	Stopper with waste ell PVC	1
03-4964	B	Antique bronze waste and overflow PVC	12
03-4957P	C	Polished brass trip waste and overflow PVC	6
03-4966	B	Polished brass trip waste and overflow PVC	12
03-4960	B	Antique bronze trip waste and overflow ABS	12
03-4959P	C	Polished brass trip waste and overflow ABS	6
03-4962	B	Polished brass trip waste and overflow ABS	12

WASTE AND OVERFLOW HORN

03-5020	B	1-3/8"	1
03-5022	B	1-1/2"	1

BATH SHOE

03-5010	B	1-3/8 Brass	10
03-5011	C	Same as above carded	6
03-5012	B	1-1/2 Brass	10
03-5013	C	Same as above carded	6
03-5014	B	1-1/2 PVC	10
03-5015	C	Same as above carded	6

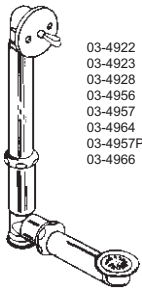

03-4922
03-4923
03-4928
03-4956
03-4957
03-4964
03-4957P
03-4966



03-4958
03-4958P
03-4959
03-4960
03-4959P
03-4962
03-4980



03-4918

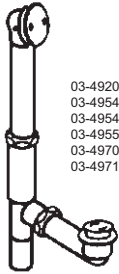

03-4920
03-4954
03-4954P
03-4955
03-4970
03-4971

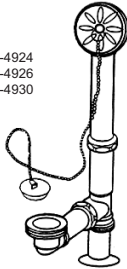

03-4924
03-4926
03-4930

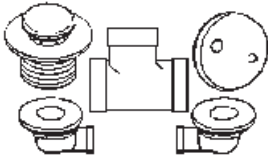

03-4941
03-4943
03-4945
03-4947



03-4948
03-4950



03-4952



03-5020



03-5022



03-5010
thru
03-5015



BATH TUB PARTS

B = BULK
C = CARDED
P = POLY BAG

ITEM NO.	PACK	DESCRIPTION	CTN. QTY.
WASTE AND OVERFLOW PLATES			
03-1403	C	Trip plate assembly with screws	6
03-1405	C	Antique Bronze trip plate assembly with screws	6
03-1407	C	Polished brass Trip plate assembly with screws	6
03-1411	C	Satin Nickel Trip plate assembly with screws	6
03-1409	C	Price Pfister trip plate with screws	6
31593*	C	Brass heavy duty trip plate with screws	6
31593PDV	C	PDV Trip plate with screws	6
03-1424	B	Two hole plate	20
03-1425	C	Same as above carded with screws	6
03-1433	C	Same as above antique bronze	6
03-1431	C	Same as above polished brass	6
31597*	C	Brass heavy duty two hole plate	6
03-1429	C	One hole plate with screw	6
03-1437	C	Same as above antique bronze	6
03-1435	C	Same as above polished brass	6
31595*	C	Brass heavy duty one hole plate	6
31595PDV	C	PVD One hole plate	6
03-1427	C	Waste and overflow strainer	6
03-1414	B	Chrome waste and overflow bolt	12
03-1417	C	Same as above carded (1 pair)	6
03-1412	B	Antique bronze waste and overflow bolt	12
03-1418	B	Polished brass waste and overflow bolt	12
03-1419	C	Same as above Carded	6
03-1443	C	Waste and overflow bolt with ring	6
03-1440	B	One hole to two hole bracket	12



31593PDV

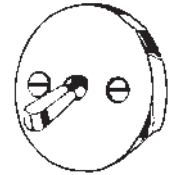

03-1403
03-1405
03-1407
03-1409
03-1411
31593*

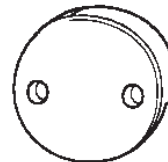

03-1424

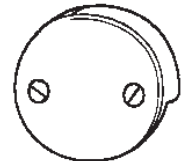

03-1425
03-1431
03-1433
31597*

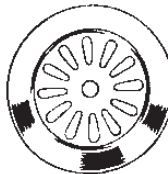

03-1427

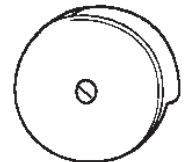

03-1429
03-1435
03-1437
31595*
31595PDV

*** ADD SUFFIX FOR FINISH**
A= Antique Bronze C= Chrome P= Polished Brass W= White

WASHERS

02-3026	B	Waste and overflow washer sponge gasket	12
02-3026P	P	Waste and overflow washer sponge gasket	12
02-3027	C	Same as above carded	6
02-3028	B	Waste and overflow washer molded	12
02-3028P	P	Waste and overflow washer molded	12
02-3029	C	Same as above carded	6
02-3030	B	Large I.D. Sponge Waste and Overflow Gasket	12
02-3031	C	Same as above carded	6
02-3036	B	Waste and overflow washer Price Pfister style	12
02-3036P	P	Waste and overflow washer Price Pfister style	12
02-3037	C	Same as above carded	6
02-3042	B	4 Ear Waste and Overflow Washer	12
02-3043	C	Same as above carded	6
02-3032	B	Bath shoe washer	12
02-3032P	P	Bath shoe washer	12
02-3033	C	Same as above carded	6
02-3034	B	Sponge Rubber bath shoe washer	12
02-3034P	P	Sponge Rubber bath shoe washer	12
02-3035	C	Same as above carded	6
02-3038	B	Thick Rubber bath shoe washer (Fine Thread)	12
02-3039	C	Same as above carded	6
02-3040	B	Thick Rubber bath shoe washer (Coarse Thread)	12
02-3041	C	Same as above carded	6



03-1442
03-1443

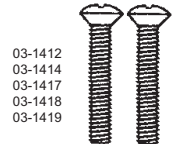

03-1412
03-1414
03-1417
03-1418
03-1419

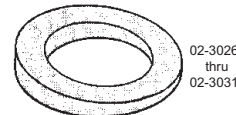

02-3026
thru
02-3031



03-1440

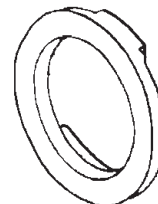

02-3036
thru
02-3037

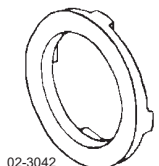

02-3042
02-3043



02-3032
thru
02-3033



02-3034
thru
02-3035



TUBULAR

B = BULK
C = CARDED

WASTE AND OVERFLOW STRAINERS AND OEM PARTS



03-5000
03-5003

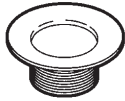

03-5005
03-5007
03-5009
34871*
34871PDV



03-4997
03-4999
31358*



03-5000
03-5001
03-4991
03-4993
31368*



03-4820

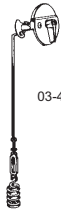

03-4753



03-4755



03-4751



03-4757



G97-180



03-4759

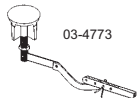

03-4773



03-4771



03-4701

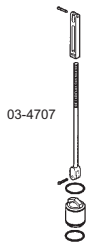

03-4707

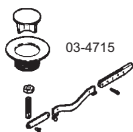

03-4715



03-4705

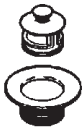

PP972-761A



PP972-751A



03-4765

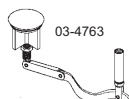

03-4763

ITEM NO.	PACK	DESCRIPTION	CTN. QTY.
----------	------	-------------	-----------

1-1/4 FINE THREAD

03-5002	B	Chrome standard	12
03-5003	C	Same as above carded	6
03-5005	C	Antique bronze with strainer top	6
03-5007	C	Polished brass with strainer top	6
03-5009	C	Satin Nickel with strainer top	6
03-4999	C	Chrome with 5/16 tap	6
03-4997	C	Chrome with 3/8 tap	6
31358*	B	Fine thread with 5/16 tap	12
34871*	C	Same as above carded with strainer top	6
34871PDV	C	PDV Fine thread strainer	6

1-1/2 COARSE THREAD

03-5000	B	Chrome standard	12
03-5001	C	Same as above carded	6
03-4991	C	Chrome with 5/16 tap	6
03-4993	C	Chrome with 3/8 tap	6
31368*	B	Coarse thread with 5/16 tap	12
03-4820	B	Fine to coarse thread bushing adapter	12

* ADD SUFFIX FOR FINISH

A= Antique Bronze **C=** Chrome **P=** Polished Brass **W=** White

AMERICAN STANDARD

03-4751	C	Trip plate assembly	6
03-4753	C	Trip plate with striker	6
03-4755	C	Rocker arm with stopper	6

FIT - MOST

03-4757	C	Trip plate with plunger assembly	6
03-4759	C	Rocker assembly with stopper	6
G97-180	B	Lift and twist assembly	6
03-4701	C	Universal bucket and wire assembly	6
03-4771	C	Universal striker and wire assembly	6
03-4773	C	Universal rocker arm with stopper	6

PRICE PFISTER

03-4705	C	Bucket and wire assembly	6
03-4707	C	Plastic bucket and wire assembly	6
03-4715	C	Rocker assembly with stopper	6
PP972-761A	B	Turnstop plug assembly	1
PP972-751A	B	Turnstop plug only	1

SAYCO

03-4763	C	Rocker assembly with stopper	6
03-4765	C	Lift and spin stopper 1-1/4 fine thread	6



STRAINERS WITH STOPPERS

B = BULK
C = CARDED

ITEM NO.	PACK	DESCRIPTION	CTN. QTY.
----------	------	-------------	-----------

ZINC STRAINERS

03-4804	B	1-1/4" Lift and Lock	12
03-4805	C	Same as above carded	6
03-4806	B	1-1/2" Lift and Lock	12
03-4807	C	Same as above carded	6
03-4812	B	1-1/2" Tip Toe	12
03-4813	C	Same as above carded	6

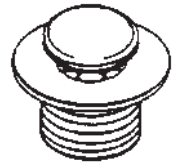

BRASS STRAINERS

03-4809	C	1-1/4" or 1-1/2" Tip Toe *	6
03-4891	C	1-1/4" or 1-1/2" Lift and Lock with overflow plate*	6
03-4893	C	Antique bronze 1-1/4" or 1-1/2" Lift and Lock*	6
03-4895	C	Polished brass 1-1/4" or 1-1/2" Lift and Lock*	6
03-4897	C	1-1/4" or 1-1/2" Pull and Drain less overflow plate*	6
03-4899	C	1-1/4 or 1-1/2 Pull and Drain with overflow plate*	6

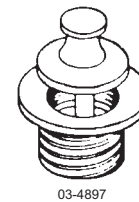
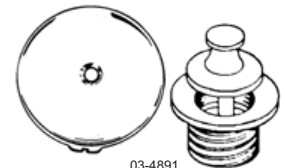
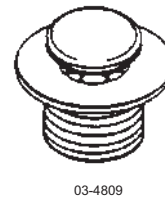

* Fine thread strainers with bushings for 1-1/2 coarse thread

DECORATIVE STRAINERS



31359*	C	1-1/4" or 1-1/2" Brass top Tip Toe	6
34861*	C	1-1/4" or 1-1/2" Lift and Lock with overflow plate	6
34898*	B	Heavy duty boxed Push and Pull stopper with brass strainer and 1-1/4 - 1-1/2 bushing and overflow plate	12
34899*	C	Same as above carded	6

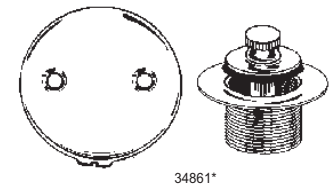
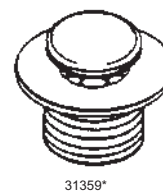
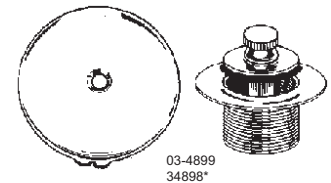

* Add Suffix for finish

A = Antique Bronze C = Chrome P = PVD W = White SN = Satin Nickel
VB = Venetian Bronze OB = Oil Rubbed Bronze

PLUMBER PAKS (Bulk pack is LESS SAN TEE)

03-4940	B	Chrome plated closure assembly ABS	12
03-4941	C	Same as above carded	6
03-4942	B	Antique bronze closure assembly ABS	12
03-4943	C	Same as above carded	6
03-4944	B	Polished brass closure assembly ABS	12
03-4945	C	Same as above carded	6
03-4946	B	Chrome plated closure assembly PVC	12
03-4947	C	Same as above carded	6
03-4950	B	Waste ell with stopper ABS	12
03-4952	B	Waste adapter with stopper ABS	12
03-4948	B	Waste ell with stopper PVC	12

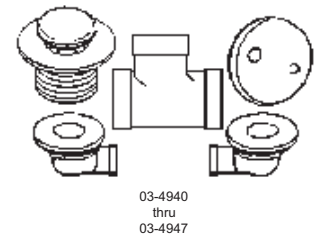

B = BULK
C = CARDED

STRAINER STOPPERS

ITEM NO.	PACK	DESCRIPTION	CTN. QTY.
----------	------	-------------	-----------

STOPPERS ONLY



03-4821
thru
03-4827



03-4831
thru
03-4835

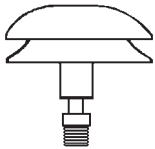

03-4827



03-4864

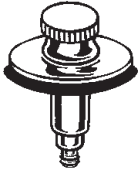

03-4880
thru
03-4883

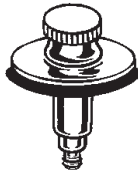

03-4884
thru
03-4889



03-4886

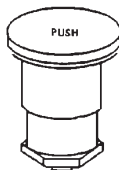

03-4901
thru
03-4901PB

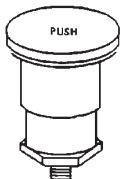

03-4903
thru
03-4903PB

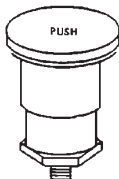

31360*
31361*



03-4907

03-4821	C	Rapid Fit 5/16" x 2"	6
03-4823	C	Rapid Fit 3/8" x 1-3/4"	6
03-4825	C	Rapid Fit 3/8" x 2"	6
03-4831	C	Antique bronze Rapid Fit 3/8" x 2"	6
03-4833	C	Polished brass Rapid Fit 3/8" x 2"	6
03-4827	C	Chrome plated brass top 3/8" x 2"	6
03-4864	B	Casper replacement gasket only	12
03-4880	B	Chrome plated Push-Pull with 5/16" & 3/8" stems	12
03-4881	C	Same as above carded	6
03-4882	B	Antique bronze Push-Pull with 5/16" & 3/8" stems	12
03-4883	C	Same as above carded	6
03-4884	B	Polished brass Push-Pull with 5/16" & 3/8" stems	12
03-4885	C	Same as above carded	6
03-4888	B	White Push-Pull with 5/16" & 3/8" stems	12
03-4889	C	Same as above carded	6
03-4886	B	Push-Pull gasket only	12
03-4901	C	Chrome plated Tip Toe 5/16"	6
03-4901AB	C	Antique bronze Tip Toe 5/16"	6
03-4901PB	C	Polished brass Tip Toe 5/16"	6
03-4903	C	Chrome plated Tip Toe top 3/8"	6
03-4903AB	C	Antique bronze Tip Toe top 3/8"	6
03-4903PB	C	Polished brass Tip Toe top 3/8"	6
31360*	B	Tip Toe brass top 5/16"	6
31361*	C	Same as above carded	6
03-4907	C	Tip Toe gasket only	6

*Add Suffix for finish

A = Antique Bronze C = Chrome P = Polished Brass W = White



STRAINERS AND STOPPERS

B = BULK
C = CARDED

ITEM NO.	PACK	DESCRIPTION	CTN. QTY.
----------	------	-------------	-----------

CUP AND TUB STRAINERS

03-1312	B	1" Cup strainer	24
03-1313	C	Same as above carded	6
03-1314	B	1-1/2" Strainer less post	24
03-1315	C	Same as above carded	6
03-1316	B	1-1/2" Strainer with post	24
03-1317	C	Same as above carded	6
03-1318	B	1-1/2" Laundry tray strainer	24
03-1319	C	Same as above carded	6
03-1330	B	1-5/8" 3-Prong strainer	24
03-1331	C	Same as above carded	6
03-1332	B	1-7/8" 3-Prong strainer	24
03-1333	C	Same as above carded	6
03-1336	B	1-7/8" Flat strainer	24
03-1338	B	Price pfister 3-prong strainer	24
03-1339	C	Same as above carded	6
PP972-700N	B	Antique bronze Price Pfister strainer	1
PP972-700P	B	Polished brass Price Pfister strainer	1
03-1340	B	2-3/4" Shoulder strainer	12
03-1341	C	Same as above carded	6
03-1346	B	4-5/8" Sink strainer	12
03-1347	C	Same as above carded	6
03-1348	B	Everbright strainer	12
03-1349	C	Same as above carded	6
03-1352	B	1-1/2" Urinal drain	1
03-1360	B	Chrome strainer with screw (Gerber Style)	12
03-1361	C	Same as above carded	6
03-1362	B	Antique bronze strainer with screw	12
03-1363	C	Same as above carded	6
03-1364	B	Polished brass strainer with screw	12
03-1365	C	Same as above carded	6
03-1371	C	4" Stainless steel shower grate with screws	6

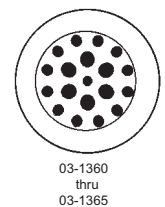
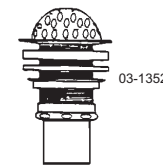
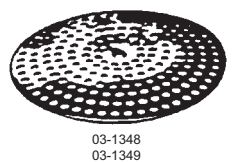
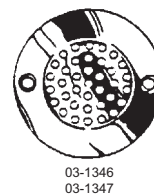
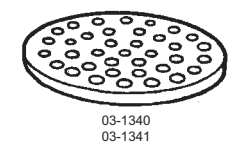
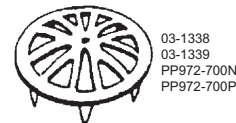
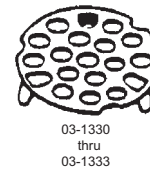
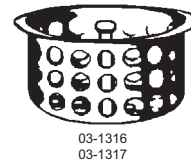
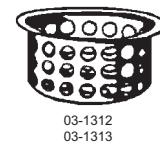

RUBBER STOPPERS

02-3160	B	1-1/8 or 1-1/4 Black commercial with chain	100
02-3161	C	Same as above carded	6
02-3200	B	1" White hollow	12
02-3201	C	Same as above carded	6
02-3202	B	1-1/8" White hollow	12
02-3203	C	Same as above carded	6
02-3204	B	1-1/4" White hollow	12
02-3205	C	Same as above carded	6
02-3206	B	1-3/8" White hollow	12
02-3207	C	Same as above carded	6
02-3208	B	1-1/2" White hollow	12
02-3209	C	Same as above carded	6
02-3210	B	1-5/8" White hollow	12
02-3211	C	Same as above carded	6
02-3212	B	1-3/4" White hollow	12
02-3213	C	Same as above carded	6

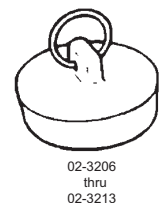
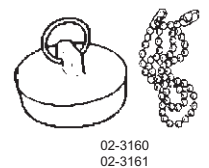
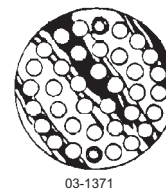

B = BULK
C = CARDED

STOPPERS AND BEADED CHAIN

ITEM NO.	PACK	DESCRIPTION	CTN. QTY.
----------	------	-------------	-----------

RUBBER STOPPERS CONTINUED

02-3214	B	1-7/8" White hollow	12
02-3215	C	Same as above carded	6
02-3216	B	2" White hollow	12
02-3217	C	Same as above carded	6
02-3230	B	1" to 1-3/8" Fit-all	12
02-3231	C	Same as above carded	6
02-3232	B	1-1/2" to 2" Fit-all	12
02-3233	C	Same as above carded	6
02-3310	B	4 3/4" Flat suction stopper	12
02-3311	C	Same as above carded	6

BEADED CHAIN

02-3430	B	R-20 Basin and bath stopper split ring	100
02-3432	B	R-21 Basin and bath stopper key ring	100
02-3451	C	11" Chrome beaded chain	6
02-3453	C	15" Chrome beaded chain	6
02-3460	B	C-34 B Type beaded chain coupling	100
02-3462	B	C-35 A Type beaded chain coupling	100
02-3470	B	C-32 Beaded chain 100ft roll	1
02-3472	B	C-32A Beaded chain 250ft roll	1
02-3474	B	C-32B Beaded chain 500ft roll	1
02-3360	B	#3-6 A Type brass coupling	100
02-3362	B	#3-6 A Type nickel plated coupling	100
02-3364	B	#8-10 A Type brass coupling	100
02-3366	B	#8-10 A Type nickel plated coupling	100
02-3380	B	#3 B Type brass coupling	100
02-3382	B	#3 B Type nickel plated coupling	100
02-3384	B	#4 B Type brass coupling	100
02-3386	B	#6 B Type nickel plated coupling	100
02-3392	B	#10 B Type brass coupling	100
02-3394	B	#10 B Type nickel plated coupling	100
02-3400	B	#3 Brass beaded chain 100ft roll	1
02-3402	B	#3 Brass beaded chain 500ft roll	1
02-3404	B	#3 Nickel plated beaded chain 100ft roll	1
02-3406	B	#3 Nickel plated beaded chain 500ft roll	1
02-3408	B	#6 Brass beaded chain 100ft roll	1
02-3410	B	#6 Brass beaded chain 500ft roll	1
02-3412	B	#6 Nickel plated beaded chain 100ft roll	1
02-3414	B	#6 Nickel plated beaded chain 500ft roll	1
02-3422	B	#10 Brass beaded chain 100ft roll	1
02-3424	B	#10 Brass beaded chain 500ft roll	1
02-3426	B	#10 Nickel plated beaded chain 100ft roll	1
02-3428	B	#10 Nickel plated beaded chain 500ft roll	1

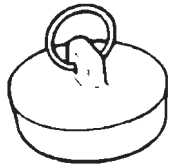

02-3214
thru
02-3217

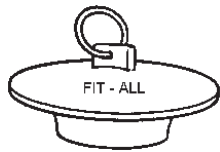

02-3230
thru
02-3233

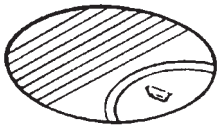

02-3310
02-3311



02-3432



02-3430



02-3460



02-3462

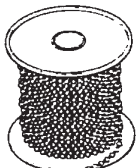

02-3470
thru
02-3474



02-3451
02-3453



02-3360
thru
02-3366



02-3380
thru
02-3394

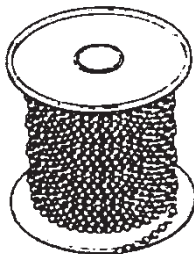

02-3400
thru
02-3428



SHOWER DRAINS

**B = BULK
C = CARDED**

ITEM NO.	PACK	DESCRIPTION	CTN. QTY.
EZ TEST STYLE			
03-1200	B	1-1/2" IPS cast iron body & top	12
03-1202	B	2" IPS cast iron body & top	12
03-1208	B	2" Caulk-in cast iron body & top	12
03-1214	B	2" IPS C.I. Top/Plastic body	12
03-1212	B	2" ABS Glue-on • S.S. top • Plastic body	20
03-1212P	B	2" PVC Glue-on • S.S. top • Plastic body	20
03-1190	B	2" Quick connect C.I. top & body	12
03-1216	B	2" Gasketed plastic top & body Fits 2" C.I., PVC, ABS, or Steel Fits inside 4" PVC pipe	18

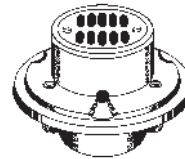

03-1200
thru
03-1214



03-1216

FIBERGLASS SHOWERS

03-1222	B	2" Brass body • S.S. Snap-in grid • Compression gasket • Fits 2" C.I., PVC, ABS, or Steel	20
03-1223	C	(Same as above carded)	1
03-1250	B	2" Plastic body • Snap-in grid • Compression gasket • Fits 2" C.I., PVC, ABS, or Steel	40
03-1251	C	(Same as above carded)	1
03-1254	B	2" PVC glue-on • With S.S. snap-in grid	50
03-1258	B	2" ABS glue-on • With plastic snap-in grid	12
03-1224	C	WingTite • Installs from the top	12



03-1222
thru
03-1258

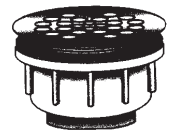

03-1180
03-1182



03-1224

TWO PIECE • RECEPTOR BASE DRAIN

03-1180	B	2" ABS • S.S. grid strainer	50
03-1182	B	2" PVC • S.S. grid strainer	50
03-1246	B	2" or 3" ABS shower drain	50
03-1248	B	3" or 4" ABS shower drain	50



03-1246
03-1248



03-1230
thru
03-1237

THREAD-ON SHOWER DRAIN

03-1230	B	1-1/2" IPS brass shower drain	50
03-1231	C	(Same as above carded)	6
03-1232	B	2" IPS brass shower drain	50
03-1233	C	(Same as above carded)	6
03-1236	B	1-1/2" IPS plastic shower drain	36
03-1237	C	(Same as above carded)	6

SURE FIT GASKET

03-1252	B	Replacement gasket for quick connect	12
03-1253	C	(Same as above carded)	6



03-1252
03-1253



Simpatico

B = BULK
C = CARDED

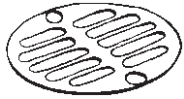

31289*
31291*



XS-7
XS-11



31341*



31353* 31353PDV
31355* 31355PDV
31355SN



31357*



31381*
31383*
31385*



31400
31401

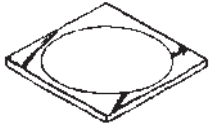

03-1218
03-1218C
03-1219



03-1220



03-1240
03-1243
03-1244
03-1247

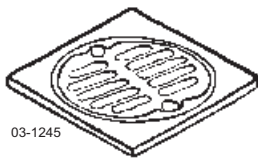

03-1245



03-1371



03-1271
03-1273



03-1256
03-1257



03-1355
03-1357



03-1260
thru
03-1265

ITEM NO.	PACK	DESCRIPTION	CTN. QTY.
----------	------	-------------	-----------

DECORATIVE SHOWER STRAINERS

31289*	C	3-1/4" Drain grate with screws	6
31291*	C	4" Drain grate with screws	6
XS-7	B	3/8 x 8-32 Shower drain screw	12
XS-11	B	1/4 x 8-32 Shower drain screw	12
31341*	C	Tile square with crown ring and grate	6
31353*	C	3-1/4" Casper snap-in strainer	6
31355*	C	4-1/4" Casper snap-in strainer	6
31357*	C	4-1/2" Flat snap-in strainer	6
31381*	C	2" Snap-in shower strainer	6
31383*	C	3" Snap-in shower strainer	6
31385*	C	4" Snap-in shower strainer	6
31400*	B	Roman Tub Drain Top Only w/Screws	6
31401*	C	Roman Tub Drain Top Only w/Screws	6

SHOWER DRAIN PARTS

03-1218	B	4" Tile square - 4-3/8" O.D. x 3-5/8" I.D.	12
03-1218C	B	CP Tile square - 5-3/4" O.D. x 4-3/8" I.D.	12
03-1219	C	Same as 03-1218 above carded	6
03-1220	B	Drain crown ring	12
03-1240	B	3-1/4" Shower drain strainer	12
03-1243	C	Same as above carded with screws	6
03-1244	B	3-1/2" Shower drain strainer	12
03-1247	C	Same as above carded with screws	6
03-1371	C	4" Shower drain grate	6
03-1245	C	4" Tile square with strainer kit	6
03-1271	C	Antique bronze crown ring with strainer	6
03-1273	C	Polished brass crown ring with strainer	6
03-1256	B	Plastic snap-in grate	12
03-1257	C	Same as above carded	6
03-1355	C	4-1/4" Chrome plated snap-in grate	6
03-1357	C	3-1/4" Chrome plated snap-in grate	6
03-1260	B	2" Snap-in shower drain	12
03-1261	C	Same as above carded	6
03-1262	B	3" Snap-in shower drain	12
03-1263	C	Same as above carded	6
03-1264	B	4" Snap-in shower drain	12
03-1265	C	Same as above carded	6

* Add Suffix for finish

A = Antique Bronze C = Chrome P = Polished Brass W = White AL = Almond
SN = Satin Nickel





B = BULK
C = CARDED

ITEM NO.	PACK	DESCRIPTION	CTN. QTY.
DECORATIVE SURE GRIP FLANGES			
31203*	C	1/2" Shower arm plated brass	6
31213*	C	1/2" copper plated brass	6
31223*	C	1/2" IPS plated brass	6
31253*	C	1-1/4" Tubular plated brass	6
31263*	C	1-1/4" Deep plated brass	6
31273*	C	1-1/2" Tubular plated brass	6
31283*	C	1-1/2" Deep plated brass	6

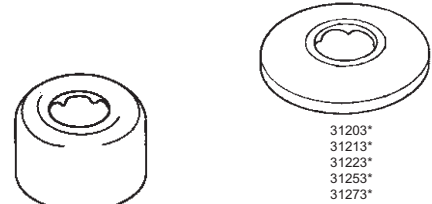

SHOWER REPAIR PLATES

03-1650	B	#1 Smitty plate 5" DIA. Hole	1
31657*	C	Same as above carded	1
03-1652	B	#2 Smitty plate 2 Hole 8" Center	1
31653*	C	Same as above carded	1
03-1654	B	#3 Smitty plate 3 Hole 8" Center	1
31655*	C	Same as above carded	1
03-1646	B	One hole plate 3-1/2" DIA. Hole	1
03-1648	B	One hloe plate 4-1/2" DIA. Hole	1
03-1660	B	Moen Repair plate 1920	1
03-6010	B	CP Trim plate for tub spout 3-1/2"O.D.	10
03-6011	C	Same as above carded	6
03-6012	B	PB Trim plate for tub spout 3-1/2"O.D.	10
03-6013	C	Same as above carded	6

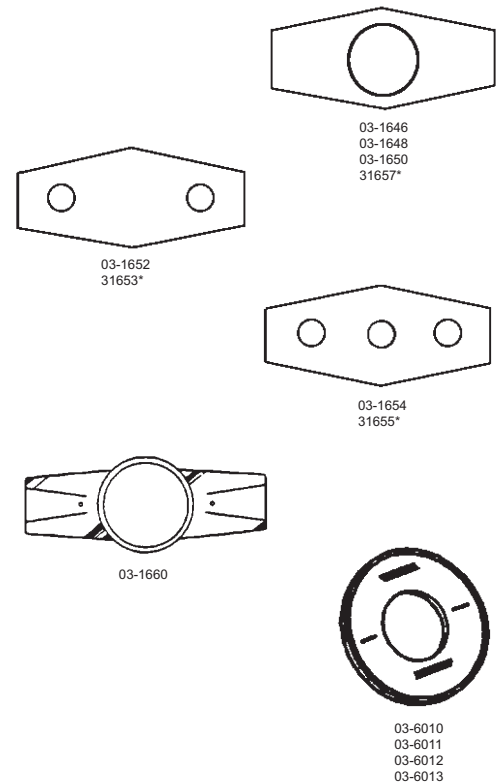

* Add Suffix for finish

A = Antique Bronze C = Chrome P = Polished Brass W = White AL = Almond
SN = Satin Nickel

02/16/05



CLEANOUT FITTINGS & RELIEF VALVES

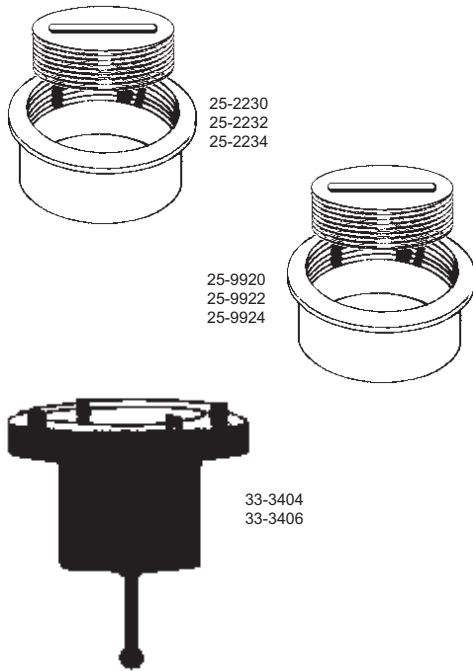

ITEM NO.	DESCRIPTION	CTN. QTY.
QUICK-FIT CLEANOUT FITTING WITH PLUG (Glues into I.D. of plastic pipe)		
25-2230	2" ABS Quick-Fit Cleanout Fitting with Plug	50
25-2232	3" ABS Quick-Fit Cleanout Fitting with Plug	50
25-2234	4" ABS Quick-Fit Cleanout Fitting with Plug	50
25-9920	2" PVC Quick-Fit Cleanout Fitting with Plug	50
25-9922	3" PVC Quick-Fit Cleanout Fitting with Plug	50
25-9924	4" PVC Quick-Fit Cleanout Fitting with Plug	50

PLASTIC SEWER RELIEF VALVES

33-3404	3" PVC Sewer Relief Valve	1
33-3406	4" PVC Sewer Relief Valve	1

HANDY-SHIELD SAFETY COVERS

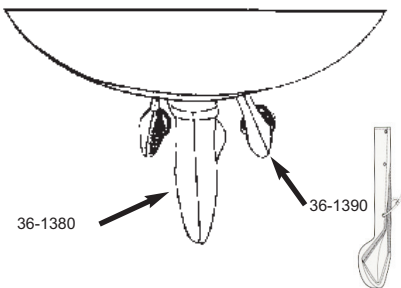

36-1380	White P-Trap Cover	10
36-1390	White Valve and Supply Cover	10

RESTAURANT DRAIN & STAND PIPES

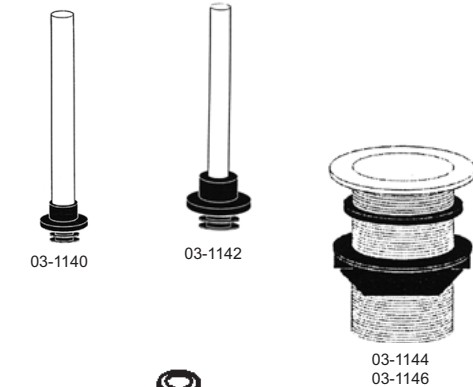

03-1104	RB 1 x 4 Drain Waste Socket with nut and washer	25
03-1106	RB 1½" Drain Waste Socket	25
03-1140	1" Stand Pipe Assembly	25
03-1142	1½" Stand Pipe Assembly	25
03-1144	1" Sink Drain Assembly	20
03-1146	1½" Sink Drain Assembly	20

CONDENSATE TRAPS

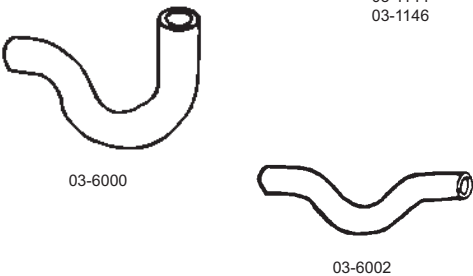

03-6000	¾" PVC P-Trap	10
03-6002	¾" PVC Running Trap	10



CLEANOUT PLATES & PLUGS

CLEANOUT COVER PLATES

ITEM NO.	DESCRIPTION	CTN. QTY.
03-1680	4" Flat Stainless Steel with Screw	10
03-1682	5" Flat Stainless Steel with Screw	10
03-1684	6" Flat Stainless Steel with Screw	5
03-5600	4-1/2" Doomed ABS White (Paintable)	25
03-5604	7-1/2" Doomed ABS White (Paintable)	25
03-5610	4-1/2" Doomed ABS Chrome	25
03-5614	7-1/2" Doomed ABS Chrome	25

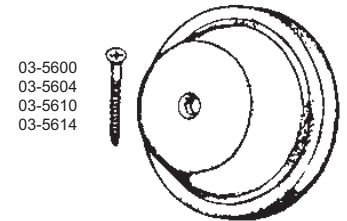
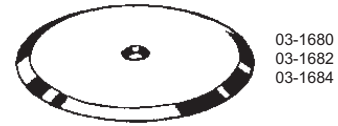

BRASS CLEANOUT PLUGS



SIZE	RAISED UPC	RAISED LIGHT	SLOTTED UPC	SLOTTED LIGHT	CTN. QTY.
1-1/2"	33-3084	33-3100	33-3184	33-3200	5
2"	33-3090	33-3102	33-3190	33-3202	5
2-1/2"	33-3092		33-3192		5
3"	33-3094	33-3106	33-3194	33-3206	5
3-1/2"	33-3096		33-3196		5
4"	33-3098	33-3110	33-3198	33-3210	5

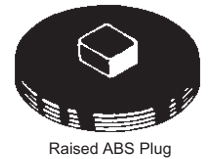
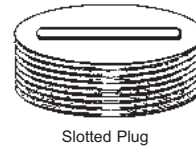
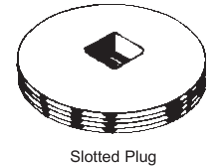
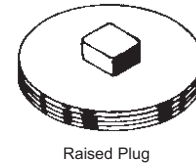

PLASTIC CLEANOUT PLUGS ABS & PVC

SIZE	RAISED ABS	CTN. QTY.	RAISED PVC	CTN. QTY.	SLOTTED ABS	CTN. QTY.	SLOTTED PVC	CTN. QTY.
1-1/2"	25-3051	100	25-9820	100	33-3284	50	33-3300	50
2"	25-3052	100	25-9822	100	33-3290	50	33-3302	50
2-1/2"	25-3055	50			33-3292	50		
3"	25-3053	25	25-9824	25	33-3294	50	33-3306	50
3-1/2"	25-3056	30			33-3296	50		
4"	25-3054	30	25-9826	30	33-3298	25	33-3310	50

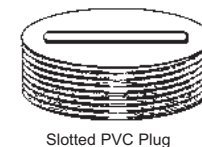
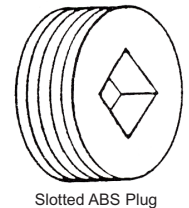
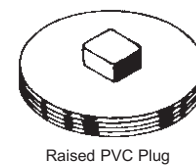

BULK NO.	DESCRIPTION	CTN. QTY.
13-2412	Cleanout Plug Wrench	10

